



ALTRAN®

SISTEMAS PARA DECORAR CORTINAS

SOLUCIONES DECORATIVAS PARA TODOS LOS HOGARES

2019

barras de cortinas
rieles motorizados
rieles técnicos
paneles japoneses
galerías
estores
accesorios confección
rieles decorativos ■

curtain poles
motorized tracks
technical rails
sliding panels
pelmet
roman blinds
curtain accessories
decorative rails ■

tringles à rideaux
rails motorisés
rails techniques
parois japonaises
cantonnières
stores bateaux
accessoires à rideaux
rails décoratifs ■



GRACIAS POR SU CONFIANZA:



Altran, desea darle las gracias por depositar su confianza en nuestra empresa. Es un honor para nosotros, como empresa española especializada en la fabricación de sistemas decorativos y técnicos para decorar cortinas, que nos haya elegido.

Este último año hemos tenido una actividad frenética colaborando en numerosos **proyectos decorativos** en Hoteles de todo el mundo (así como en hospitales, teatros y por supuesto, residenciales); también hemos participado en la decoración de **series de TVE**; hemos realizado **campañas de concienciación** para que el consumidor confíe solo en profesionales del cortinaje como usted; participando en **ferias nacionales** (Feria del Mueble de Zaragoza, Veteco Madrid, InteriHotel...) y en **ferias internacionales** (R+T Stuttgart, Heimtextil Frankfurt, Interior Lifestyle Tokyo...); pero sobre todo, **desarrollando productos técnicos** que nuestros amigos y clientes nos han solicitado para solucionar algunos de los problemas que han tenido, de este modo hemos diseñado la Corredera Aérea, el Riel Decotrack, el Riel Decotrim, un riel motorizado capaz de retener una cortina inclinada y nuevos colores y terminales para sistemas decorativos.

Todo este esfuerzo lo hemos recogido en nuestro **CATÁLOGO 2019** donde incluimos las últimas novedades y todos los productos que nos han llevado a ganar su confianza y a consolidarnos como una marca referente para todo profesional de la decoración y del cortinaje. Esperamos que le guste y que le sirva para dar solución a cualquier tipo de instalación.

Nuestro servicio, nuestra calidad y la versatilidad de nuestro producto nos está llevando a una posición cada vez más importante en este sector, por ello nos orgullece que nos considere como su proveedor habitual. Altran se ha convertido en una de las principales empresas fabricantes españolas, con presencia internacional en los 5 continentes y se lo debemos a usted.

Es muy complicado para una pyme luchar en un mercado tan competitivo lleno de multinacionales y de plataformas de venta masiva por Internet. Por eso estamos obligados a mantener nuestro **compromiso de Calidad Total** con usted porque su apoyo es muy importante. Debemos reafirmarnos en nuestra filosofía empresarial y esforzarnos por usted, no solo presentando un buen catálogo, sino convirtiéndonos en una empresa con principios y actuar en consecuencia. Por lo tanto debemos mejorar nuestra calidad, ajustar los precios, fabricar en España, darle las garantías firmadas y selladas para su total seguridad y mejorar nuestro servicio.

Y además, como parte de nuestra filosofía, consideramos que es importante apoyar a los más necesitados. Hay muchas personas que sufren cada año las consecuencias de un capitalismo exacerbado mal entendido. Esas personas también necesitan ayuda y por lo tanto, parte del beneficio de Altran se destina cada año a **campañas sociales**. En esta ocasión, contar con Altran, supone que estará ayudando a los más desfavorecidos gracias a la alianza empresarial entre La Caixa, Gavi y Altran.

Le recordamos que Altran solo vende a profesionales, nunca a particulares y mucho menos directamente a través de plataformas de venta masiva debido a nuestro **compromiso de Lealtad** de cara a usted y como forma de devolverle las gracias por su apoyo.

José Vicente Ferrer Agulló
Gerente de Altran Solutions SL

PATROCINADOR PLATA

ALTRAN SOLUTIONS, S.L.
Alianza Empresarial para la Vacunación Infantil
una iniciativa de Gavi the Vaccine Alliance y "la Caixa", con la colaboración de ISGlobal, para la lucha contra la mortalidad infantil en los países más pobres del mundo.

Cada vez que cuentas con Altran para tus proyectos, estás colaborando con los más desfavorecidos

GRACIAS POR HACERLO POSIBLE



Presentation of the Project "Altran Solutions SL"

Présentation du Projet "Altran Solutions SL"

THANK FOR YOUR TRUST:



Altran would like to thank you for your trust in our company. As a Spanish company specialized in the manufacture of decorative and technical systems to decorate curtains, it is an honor for us to be elected.

Last year we had a frenetic activity taking part in many decorative projects in hotels around the world (as well as hospitals, theaters and of course, residential homes and facilities); we have also participated in the decoration of TVE series; we have carried out awareness campaigns to get the consumer trusts only in curtain professionals like you; participating in national fairs (Zaragoza Furniture Fair, Veteco Madrid, InteriHotel ...) and in International fairs (R + T Stuttgart, Heimtextil Frankfurt, Interior Lifestyle Tokyo ...); but above all, developing technical products that our friends and customers have asked us to solve some of the problems they have had, in this way we have designed the final master carrier, the Decotrack Rail, the Decotrim Rail, a motorized rail capable of retaining a curtain inclined and new colors and finials for decorative systems.

All this effort is embodied in our **CATALOGUE 2019** where we include the latest news and developments that have led us to get their trust and consolidate as a benchmark for all professional decorating and drapery. We hope you like it and that it will help you solve any type of installation.

Our service, our quality and the versatility of our product lead us to an increasingly important position in this sector, and we are proud you to consider us as your usual supplier. Altran has become one of the leading Spanish manufacturers, with an international presence in the 5 continents and we owe it to you.

It is very difficult for an SME to fight in such a competitive market full of multinationals and mass-selling platforms over the Internet. That is why we should keep our commitment to Total Quality with you because your support is very important. We must reaffirm our business philosophy and strive for you, not only presenting a good catalog, but becoming a company with principles and acts accordingly. Therefore we must improve our quality, adjust prices, manufacture in Spain, give signed and sealed guarantees for your total security and improve our service.

And also, as part of our philosophy, we consider it important to support the most needy. There are many people who suffer every year the consequences of an exacerbated capitalism misunderstood. These people also need help and therefore part of the Altran benefit goes to social campaigns every year. On this occasion, choosing Altran, means helping the most disadvantaged thanks to the business alliance between La Caixa, Gavi and Altran.

We remind you that Altran only sells to professionals, never to individuals and much less directly through massive sales platforms due to our commitment of customer Loyalty, a way to thank you for your support.



MERCI POUR VOTRE CONFIANCE:

Altran vous remercie de votre confiance en notre société. En tant qu'entreprise espagnole spécialisée dans la fabrication de systèmes décoratifs et techniques pour la décoration de rideaux, c'est un honneur pour nous d'être élus.

L'année dernière, nous avons eu une activité frénétique, participant à de nombreux projets de décoration dans des hôtels du monde entier (ainsi que des hôpitaux, des théâtres et bien sûr des résidences et installations); nous avons également participé à la décoration des séries TVE; nous avons mené des campagnes de sensibilisation pour que les consommateurs fassent confiance seulement aux professionnels du rideau comme vous; participer à des foires nationales (Salon du meuble de Saragosse, Veteco Madrid, InteriHotel ...) et à des foires internationales (R + T Stuttgart, Heimtextil Frankfurt, Interior Lifestyle Tokyo ...); mais surtout, en développant des produits techniques que nos amis et clients nous ont demandé de résoudre nous avons conçu le dernier coulisse maîtresse, le Decotrack Rail, le Decotrim Rail, un rail motorisé capable de retenir un rideau incliné et de nouvelles couleurs et embouts pour systèmes décoratifs.

Tous ces efforts sont concrétisés dans notre **CATALOGUE 2019**, dans lequel nous présentons les dernières nouvelles et développements qui nous ont amenés à gagner votre confiance et à nous consolider comme référence pour toutes les décorations et draperies professionnelles. Nous espérons que cela vous plaira et qu'il vous aidera à résoudre tout type d'installation.

Notre service, notre qualité et la polyvalence de notre produit nous conduisent à une position de plus en plus importante dans ce secteur, et nous sommes fiers d'être votre fournisseur habituel. Altran est devenu l'un des principaux fabricants espagnols, avec une présence internationale sur les 5 continents et c'est une bonne nouvelle et c'est surtout à vous que nous la devons.

Il est très difficile pour une PME de se battre sur un marché aussi concurrentiel composé de multinationales et de plates-formes de vente en masse sur Internet. C'est pourquoi nous allons garder notre engagement envers la qualité totale avec vous, car votre soutien est très important. Nous devons réaffirmer notre philosophie d'entreprise et nous efforcer de vous présenter non seulement un bon catalogue, mais également une entreprise fondée sur des principes et agissant en conséquence. Nous devons donc améliorer notre qualité, ajuster les prix, fabriquer en Espagne, donner des garanties signées et scellées pour votre sécurité totale et améliorer notre service.

Et aussi, dans le cadre de notre philosophie, nous considérons qu'il est important de soutenir les plus démunis. De nombreuses personnes subissent chaque année les conséquences d'un capitalisme exacerbé mal compris. Ces personnes ont également besoin d'aide et une partie des bénéfices d'Altran est donc consacrée à des campagnes sociales chaque année. À cette occasion, choisir Altran, c'est aider les plus démunis grâce à l'alliance entre La Caixa, Gavi et Altran.

Nous vous rappelons qu'Altran vend uniquement aux professionnels, jamais aux particuliers et encore moins directement via des plateformes de vente massives en raison de notre engagement envers la fidélité de nos clients, une façon de vous remercier pour votre soutien.



ENVÍO DE PEDIDOS

Los pedidos se realizarán indicando nuestro número de referencia y enviándolo vía fax al +34 96 113 61 27 o vía e-mail: administracion@altransolutions.es

PORTES E I.V.A

Los pedidos se expedirán a portes pagados si el importe (base imponible) supera los 150 € y el largo no exceda de 4 m. Para pedidos con largos superiores: Consultad condiciones. Para los pedidos con portes inferiores a 150€, los portes serán cargados en factura.

El I.V.A. correrá a cargo del cliente.

ANOMALÍA DEL ENVÍO

La mercancía debe revisarse delante del repartidor. Si la mercancía llega en mal estado debe notificarse en el albarán de entrega de la agencia. No sirve poner "Pendiente de Revisión", debe especificarse qué problema hay e incluso anotar si el embalaje ha llegado en mal estado.

Si no se cumple este requisito no podremos hacernos cargo de las posibles reclamaciones. Se debe dar parte de incidencia en la recepción de la mercancía **imprescindiblemente** en el **plazo NO superior a 24 horas**. Las devoluciones de mercancía deben ir acompañadas del albarán original.

DIRECCIÓN ENVÍO ESPECIAL

En caso de necesitar que la mercancía se envíe a una dirección especial diferente a la habitual, se efectuará un cargo de 5,00€ por expedición.

PRECIOS

Los precios y los productos publicados en este catálogo tiene reservado el derecho de ser modificados sin previo aviso por el fabricante.

SEGURO

La mercancía viaja por cuenta y riesgo del comprador. Si el cliente desea asegurar la mercancía, correrá por parte del cliente la prima de seguro.

RESERVA DE DOMINIO

Nuestras ventas se realizarán bajo reserva de dominio según el artículo 1506 de C.C. hasta que el valor de la mercancía se haya pagado íntegramente.

JURISDICCIÓN COMPETENTE

El comprador acepta que toda desavenencia se realizará bajo la jurisdicción de los tribunales de Valencia (España) renunciando expresamente a su propio fuero y domicilio.

ORDERS

Orders should be sent with reference number of each article. The orders can be sent by fax +34 96 113 61 27 or by mail to: export@altransolutions.es

PRICE

Prices shown are ex-works Valencia. Due to the fluctuations of the international markets beyond our control, prices and terms of sale are subject to change without prior notice.

RETURN SHIPMENTS

Returned goods will not be accepted without our prior authorization.

CLAIMS

Goods must be checked upon arrival. Claims for faulty/wrong shipments and/or shortages must be made within **3 days** of receipt of goods. Claims for transport damages must be filled against the carrier immediately upon receipt.

RIGHTS RESERVED

Our sales are always considered under the condition "Rights reserved" according to article 1506 C.C. until full payment has been settled.

VALID JURISDICTION

In case of discrepancies, disagreements or litigation, the jurisdiction of the Valencia (Spain) Courts of Law will prevail and will be accepted by the customer with waiver of his own jurisdiction of venue.

COMMANDES

Les commandes doivent être envoyées avec le numéro de référence de chaque article. Veuillez nous envoyer vos commandes par fax +34 96 113 61 27 ou par e-mail: export@altransolutions.es

PRIX

Les prix indiqués dans le catalogue sont départ d'usine (exworks). A cause des fluctuations des marchés internationaux, les prix et les conditions de vente sont sujets à changement sans préavis.

RETOUR DE MARCHANDISE

Les marchandises retournées ne seront pas acceptés sans notre autorisation préalable.

RÉCLAMATIONS

Les marchandises doivent être vérifiées à l'arrivée. Les retours erreur d'envoi ou défaut de qualité doivent être faites dans les **3 jours** suivants à la réception de la marchandise. Les réclamations pour dommages de transport doivent être remplis sur le bon de livraison du transporteur dès réception.

CLAUSE DE RÉSERVE DE PROPRIÉTÉ

Nos ventes sont toujours considérés comme la condition "Droits réservés" selon l'article 1506 CC jusqu'au paiement intégral a été réglée.

JURISDICTION COMPÉTENTE

IL'acheteur accepte qu'en cas de litige, Le tribunal compétent sois celui de Valencia (Espagne).

Curvatura de Rieles

RAILS BENDING INSTRUCTIONS / INSTRUCTIONS POUR CINTRAGE DES RAILS

CARACTERÍSTICAS GENERALES

MAIN FEATURES / CARACTÉRISTIQUES GÉNÉRALES

El Coste **incluye**: curvado, empaquetado y gastos adicionales de envío. Por su comodidad **consulte** siempre fechas de entrega y precios. El cliente debe proporcionar siempre una **plantilla** a tamaño real con el arco y radio de la curvatura. En el caso de que el cliente no la aporte, Altran cobrará un importe de 31,50 € PVP (Ref. M.140). En los Rieles con más de una curva en Ángulo con el mismo grado, se cobrará 1 curvatura. Los Rieles con 2 o más Curvas en el mismo perfil, se servirán en 1 pieza siempre que sea posible. Si no fuera posible, el riel se servirá empleando empalmes para asegurar el deslizamiento correcto de las correderas. The cost

includes: Curving, packaging and additional shipping charges. For your convenience always **check** delivery dates and prices. The customer should always provide an actual size **template** with the arch or radius of curvature. In the case that the client does not supply it, Altran will charge an amount of € 31,50 SRP (Ref. M.140). In Rails with more than one Angle curve with the same degree, one curvature will be charged. Rails with 2 or more curves in the same profile will be served in 1 piece whenever possible. If this is not possible, by using the rail joints we ensure the correct slip sliding.

Le coût **comprend**: la courbure, l'emballage et frais de livraison supplémentaires. Pour votre commodité toujours **vérifier** les dates de livraison et les prix. Le client doit toujours fournir un **modèle** de taille réelle avec un arc et rayon de courbure. Dans le cas où le client ne fournit pas, nous facturons un montant de € 31,50 PVP (Ref. M.140). Dans Rails avec plus d'une courbe en Angle avec les mêmes de degrés, une courbure sera facturée. Rails avec deux ou plusieurs courbes dans le même profil seront fournis dans une pièce chaque fois que possible. Si ce ne est pas possible, en utilisant les joints de rail nous assurons le glissement correct.

DISPONEMOS DE MÁQUINAS PROFESIONALES PARA CURVAR

Professional Curving Machine
Professionelle Machine de Courber



Arco /
Arch /
Arc



Ángulo /
Angle /
Courbure

REVA

Este Riel se curva empleando el Codo y/o el Rincón Original Reva, referenciado como:

I.205: Rincón esquina 90° - 18,86 € PVP

I.204: Codo esquina 90° - 18,86 € PVP

El radio mínimo es de 12 cm.

To bend the Rail, we use the outer/inner elbow with references:

I.205: exterior Corner 90 - € 18,86 SRP

I.204: interior Corner 90 - € 18,86 SRP

The minimum radius is 12 cm.

Pour cintrer le Rail, on utilise le coude extérieur ou intérieur avec références:

I.205: Coude ext 90 - € 18,86 PVP

I.204: Coude int 90 - € 18,86 PVP

Le rayon minimum est de 12 cm.

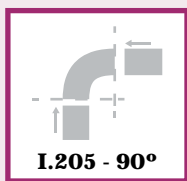

I.205 - 90°

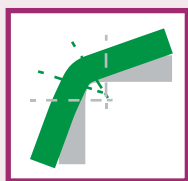
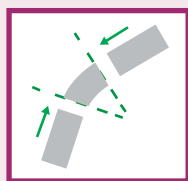

El cliente puede conseguir otro ángulo de curva si corta los extremos del I.204 o I.205. De este modo ya no existiría un ángulo de 90° sino el que se haya cortado. El cliente debe ajustar el corte y la curva en el momento de la instalación.

The customer can get another angled curving by cutting short ends I.205 or I.204. Thus it no longer exists 90° but the design that has been cut. This cut is made by the customer upon installation to adjust the curve with the wall where it will be installed.

Le client peut obtenir une autre courbe d'angle si courte les bouchons I.205 ou I.204. Ainsi ne existent plus de 90°, mais celui qu'on a coupé. Cette coupe est faite par le client lors de l'installation pour ajuster la courbe avec le mur où il sera installé.

RM09

J.RC - precio por cada curvatura en Ángulo - 86,52 € PVP

J.RA - precio por cada curvatura en Arco - 129,78 € PVP

J.RC - price per each curvature in Angle - 86,52 € SRP

J.RA - price per each bend in Arch - 129,78 € SRP

J.RC - prix par angle de Courbure - 86,52 € PVP

J.RA - prix par coude Arc - 129,78 € PVP

Curvatura en Ángulo: radio mínimo 35 cm.

Curvature angle: minimum radius 35 cm.

Angle de courbure: rayon minimum 35 cm.

TRIM

Curvar en Ángulo: 70 % del Precio Tarifa del Riel-Kit. (Coste mínimo de 14,70 € PVP).

Curvar en Arco Continuo: 35,72 € PVP

Bending in Angle: 70% of the kit tariff price. (Minimum cost € 14.70SRP).

Bending in Continuous Arch: € 35,72 SRP

Coût par courbe en Angle: 70% du prix tarif du kit.

(Coût minimum € 14,70 PVP).

Coût par cintrage en Arc continu: € 35,72 PVP

El radio mínimo es de 10 cm.

The minimum radius is 10 cm. / Le rayon minimum est de 10 cm.

El riel se sirve en una pieza. Si hubiera 2 o más curvas en Arco, se servirá cada Arco por separado. Será función del cliente ajustarlo en el momento de la instalación.

The track is served in one piece. We haven't any joining piece for this purpose. If there were 2 or more curves in Arch, the arched piece of rail is served each separately. Customer will be in charge of adjust upon installation. /

Ce rail est fourni dans une pièce parce que nous n'avons pas disponibles les raccords. S'il y avait deux ou plusieurs courbes à Arc, les arcs sont fournis chaque séparément. Le client sera en charge d'ajuster lors de l'installation.

ARGENT

Curvar en Ángulo: 70 % del Precio de Tarifa del Riel-Kit. (Coste mínimo de 14,70 € PVP).

Bending in Angle: 70% of the kit tariff price. (Minimum cost €14.70 SRP). /

Coût par courbe en Angle: 70% du prix tarif du kit.

(Coût minimum € 14,70 PVP).

El radio mínimo es de 10 cm.

The minimum radius is 10 cm. / Le rayon minimum est de 10 cm.

MALEABLE

Puede curvarse en cualquier ángulo y forma. El cliente o el instalador puede curvarlo a mano porque no requiere máquina especial.

It can be bent at any angle and shape. The customer or the installer can bend it by hand because it does not require any special machine. /

Il peut être plié à ne importe quel angle et la forme. Le client ou l'installateur peuvent se plier à la main, car il ne nécessite pas de machine spéciale.



Rieles Decorativos
Decorative Tracks
Rails Décoratifs



Barras Modernas
Modern Collection
Collection Moderne

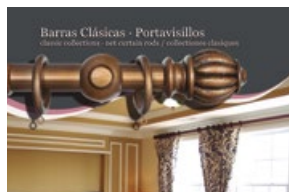

Barras Clásicas/ Portavisillos
Classic Collection /Net curtain rods
Collections classiques / Petites Tringles



Galerías
Pelmets
Cantonnières



Rieles Manuales
Hand-drawn curtain Tracks
Rails tirage Manuel



Rieles Cordón
Cord-drawn Curtain Tracks
Rails tirage Cordon



Rieles motorizados
Motorized Curtain Tracks
Rails Motorisés

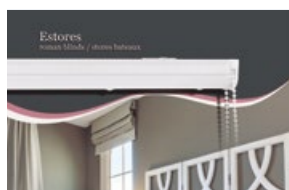

Estores
Roman Blinds
Stores Bateaux



Panel Japonés
Sliding Panel
Parois Japonaise



Accesorios de confección / Varios
Tailoring Accessories - Miscellaneous
Accessoires de Confection - Divers

LÍNEA DECORATIVA

Decorative Line / Ligne Décorative

1 . Rieles Decorativos / Decorative Tracks / Rails Décoratif	
1.1 • Riel Decotrack ®.....	008
1.2 • Riel Sintra ®.....	018
1.3 • Riel Obidos ®.....	024
1.4 • Riel Coimbra ®.....	025
1.5 • Riel Córcega.....	037
1.6 • Riel Capri.....	043
1.7 • Riel Inter.....	049
1.8 • Riel Led.....	053
1.9 • Riel Slim.....	057
2 . Barras Modernas / Modern Collections / Collections Modernes	
2.1 • Infinity 19/30	
2.1.1 • Infinity Zen.....	065
2.1.2 • Infinity Colors.....	067
2.1.3 • Infinity Vector.....	071
2.1.4 • Infinity Cristal.....	073
2.1.5 • Infinity Ice.....	075
2.1.6 • Infinity Polar.....	077
2.1.7 • Infinity Vanity.....	079
2.1.8 • Infinity Basic.....	081
2.1.9 • Infinity Exclusive.....	084
2.2 • Cavallier 19/30.....	099
2.3 • Varadero 19/30.....	109
3 . Barras Clásicas - Portavisillos / Classic Collections - Net curtain rods / Collectiones clasiques - Petites Tringles	
3.1 • Duero 19/30.....	131
3.2 • Barra para Escalera 16.....	142
3.3 • Estrado y Museo.....	143
3.4 • Forja 19/30.....	145
3.5 • Belmonte 35.....	161
3.5 • Eclipse 19/30.....	173
3.6 • Portavisillos / Net Curtain Rods / Petites Tringles.....	185
3.6.1 • Extensible Frankfurt.....	186
3.6.2 • Extensible Café.....	186
3.6.3 • Extensible Berlín.....	186
3.6.4 • Extensible Bonn.....	187
3.6.5 • Extensible Praga.....	187
3.6.6 • Barras de Baño / Shower Curtain Rod / Rideau de Douche.....	188
4 . Galerías / Pelmet / Cantonnières.	
4.1 • Color System.....	191
4.2 • Madera / Wood / Bois.....	199
4.3 • Aluminio de 10 cm / Aluminium 10 cm.....	202
4.4 • Perfil para Bandó / Pelmet Rails / Rails pour Cantonnières.....	203
4.4.1 • Star.....	203
4.4.2 • Clasic.....	203

LÍNEA BLANCA

Aluminium Profiles / Rails en Aluminium

5 . Rieles Manuales / Hand-drawn curtain Tracks / Rails Manuels	
5.1 • DecoTrim.....	207
5.2 • Trim.....	211
5.3 • Argent.....	216
5.4 • Balear.....	218
5.5 • Basic.....	220
5.6 • Riel Fijo Hierro Serie 1000.....	221
5.7 • Maleable.....	226
5.8 • Múltiple.....	228
5.9 • Reva Manual.....	232
5.10 • RM09 Manual.....	235
6 . Rieles Cordón / Cord-drawn Curtain Tracks / Rails tirage Cordon	
6.1 • RM09-Cordón.....	241
6.2 • Reva Cordón.....	245
6.3 • Extensible de Hierro-Serie 1100..	248
7 . Rieles Motorizados / Motorized Curtain Tracks / Rails Motorisés	
7.1 • RM09-TA, 43, 46, 92, 93, 95 y 1000	253
8 . Estores / Roman Blinds / Stores Bateaux	
8.1 • Easy Compact.....	265
8.2 • Startrack.....	271
8.3 • Motorizado / Motorized / Motorisé..	276
8.3 • Cadeneta.....	278
8.4 • Troya.....	284
9 . Panel Japonés y Panel Japonés Motorizado / Sliding Panel & Motorized Sliding Panel / Parois Japonaise et Parois Japonaise Motorisée	
9.1 • Panel Japonés.....	293
9.1.1 • Panel 2 Vías.....	294
9.1.2 • Panel 3 Vías.....	295
9.1.3 • Panel 4 Vías.....	296
9.1.4 • Panel 5 Vías.....	297
9.1.5 • Galería Panel / Panel Pelmet / Cantonnière Parois Japonaise....	304
9.2 • Panel Japonés Motorizado / Motorized Sliding Panel / Parois Japonaise Motorisée.....	307
10. Accesorios de Confección - Varios / Tailoring Accessories - Miscellaneous / Accessoires de Confection - Divers	
10.1 • Garfios / Hooks / Crochets.....	319
10.2 • Cintas / Tapes / Rubans.....	320
10.3 • Ollaos / Eyelets / Oeillet.....	325
10.4 • Soporte Rápido / Quick Bracket / Support Express.....	332
10.5 • Contrapesos / Cordweight / Contrepoids.....	334

Rieles Decorativos

decorative tracks / rails décoratifs



ALTRAN[®]
SISTEMAS PARA DECORAR CORTINAS

Decotrack ® 19 mm / Decotrack ® 19 mm / Decotrack ® 19 mm



Anodizado Acero corredera A Pared
Anodized steel runner Wall /
Acier anodisé glisseur Mur



Anodizado Acero corredera A Techo
Anodized steel runner Ceiling /
Acier anodisé glisseur Plafond



Anodizado Plata Gratada onda perfecta A Pared
Anodized silver perfect wave 5,5 mm Wall /
Argent anodisé onde parfaite 5,5 mm Mur



Anodizado Plata Gratada onda perfecta A Techo
Anodized silver perfect wave 5,5 mm Ceiling /
Argent anodisé onde parfaite 5,5 mm Plafond



Bronze onda perfecta 8 mm A Pared
Bronze perfect wave 8 mm Wall /
Bronze onde parfaite 8 mm Mur



Bronze onda perfecta 8 mm A Techo
Bronze perfect wave 8 mm Ceiling /
Bronze onde parfaite 8 mm Plafond



Blanco cinta acordeón A Pared
White ruffle tape Wall /
Blanc ruban accordéon Mur



Blanco cinta acordeón A Techo
White ruffle tape Ceiling /
Blanc ruban accordéon Plafond

Diseñado y patentado por Altran, este riel se presenta en 4 colores (Acero, Plata Gratada, Bronce y Blanco) y 2 diámetros (19 y 30mm). Permite el uso de correderas normales, onda perfecta y cinta acordeón, dando lugar a uno de los sistemas más completos del mercado.

Designed and patented by Altran, this track is proposed in 4 different colours (steel, anodized silver, bronze and white) and 2 diameters (19 and 30mm). It can be used with standard runners, perfect wave and ruffle tape, giving way to one of the most complete systems in the market.

Conçu et breveté par Altran, ce rail est proposé en 4 couleurs différentes (acier, argent anodisé, blanc et bronze) et en 2 diamètres (19 et 30mm). Il peut être utilisé avec des glisseurs standard, onde parfaite et ruban accordéon, créant ainsi un des systèmes les plus complets du marché.

∅ 19 / 30 mm

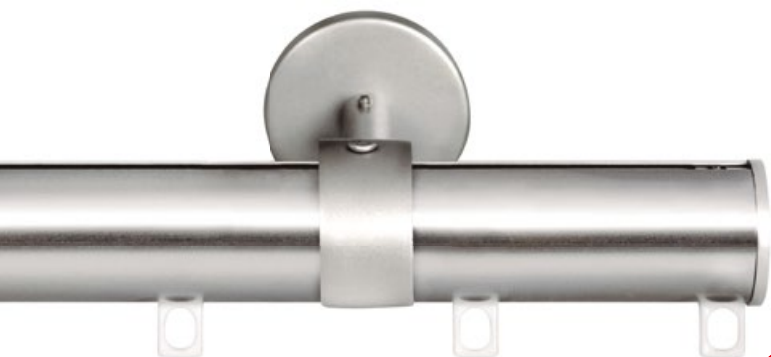

Anodizado Acero corredera A Pared
Anodized steel runner Wall /
Acier anodisé glisseur Mur



Anodizado Acero corredera A Techo
Anodized steel runner Ceiling /
Acier anodisé glisseur Plafond



**Anodizado Plata Gratada
onda perfecta A Pared**
Anodized silver perfect wave 5,5 mm Wall /
Argent anodisé onde parfaite 5,5 mm Mur



**Anodizado Plata Gratada
onda perfecta A Techo**
Anodized silver perfect wave 5,5 mm Ceiling /
Argent anodisé onde parfaite 5,5 mm Plafond

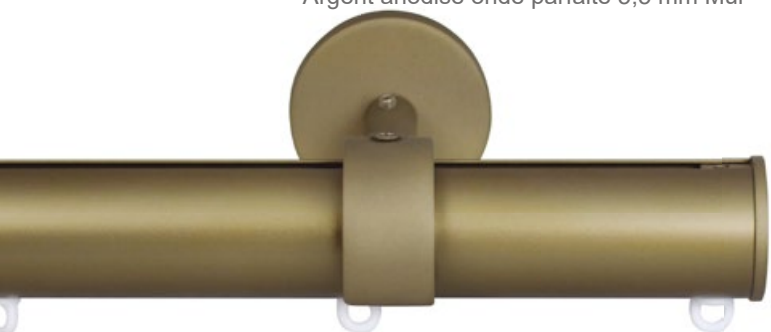

Bronze onda perfecta 8 mm A Pared
Bronze perfect wave 8 mm Wall /
Bronze onde parfaite 8 mm Mur



Bronze onda perfecta 8 mm A Techo
Bronze perfect wave 8 mm Ceiling /
Bronze onde parfaite 8 mm Plafond



Blanco cinta acordeón A Pared
White ruffle tape Wall /
Blanc ruban accordéon Mur



Blanco cinta acordeón A Techo
White ruffle tape Ceiling /
Blanc ruban accordéon Plafond

El Riel Decotrack se diferencia del resto de rieles del mercado en la personalización que podemos darle empleando los terminales decorativos en 19 y 30mm de las barras de Altran para decorar la estancia. Es compatible con soportes y terminales de otras colecciones.

The Decotrack system stands out from the rest of the curtain systems in the customization we can get by combining the existing and wide option decorative finials in 19 and 30mm. It is compatible with brackets and finials of other collections.

Le système Decotrack se distingue du reste des systèmes de rideaux par la personnalisation que nous pouvons obtenir en combinant les plusieurs embouts décoratifs existants en 19 et 30 mm. Il est compatible avec les supports et les embouts d'autres collections.

Instalación Decorativa "A Pared" con corredera D.07 /
 "Wall" decorative installation with D.07 runner /
 Option d'installation décorative "à Mur" avec glisseur D.07



Incremento para Sistema Onda Perfecta / Price increase perfect wave system / Hausse prix système onde parfaite:
 D.111: 4,80 €/m D.112: 3,30 €/m D.113: 3,30 €/m D.114: 3,30 €/m

Decotrack® Anodizado Acero / Anodized Steel Decotrack® / Decotrack® Acier Anodisé



*El Sistema Sencillo de 30mm se sirve con 2 soportes. /
 The 30mm single set is supplied with 2 brackets. /
 Le kit simple de 30mm est fourni avec 2 supports.

U	Ø 19 REF K.19018AA	Ø 30 REF K.19007AA	Ø 19/19 REF K.19019AA	Ø 30/19 REF K.19021AA	Key	Drill	cm
1	39,06 €	48,97 €	66,61 €	72,34 €	2	10	100
1	44,58 €	58,00 €	77,65 €	86,89 €	2	16	150
1	60,99 €	66,86 €	104,72 €	116,21 €	3*	20	200
1	65,74 €	87,01 €	115,77 €	130,75 €	3	26	250
1	71,86 €	96,64 €	126,46 €	144,97 €	3	30	300
1	88,44 €	117,55 €	153,88 €	174,62 €	4	36	350
1	93,79 €	126,42 €	164,57 €	188,83 €	4	40	400
1	126,59 €	174,09 €	224,42 €	261,46 €	5	60	600

Precio del conjunto completo incluyendo soporte decorativo a pared. /
 Complete set price including wall decorative bracket. / Prix kit complet compris support mur décoratif.

Decotrack® Plata Gratada / Anodized Silver Decotrack® / Decotrack® Argent Anodisé



*El Sistema Sencillo de 30mm se sirve con 2 soportes. /
 The 30mm single set is supplied with 2 brackets. /
 Le kit simple de 30mm est fourni avec 2 supports.

U	Ø 19 REF K.19018AP	Ø 30 REF K.19007AP	Ø 19/19 REF K.19019AP	Ø 30/19 REF K.19021AP	Key	Drill	cm
1	34,96 €	44,37 €	58,41 €	63,64 €	2	10	100
1	38,42 €	51,10 €	65,33 €	73,83 €	2	16	150
1	41,72 €	57,66 €	88,32 €	98,81 €	3*	20	200
1	55,48 €	75,51 €	95,25 €	108,99 €	3	26	250
1	59,56 €	82,84 €	101,86 €	118,87 €	3	30	300
1	74,08 €	101,45 €	125,16 €	144,16 €	4	36	350
1	77,39 €	108,02 €	131,77 €	154,03 €	4	40	400
1	101,99 €	146,49 €	175,22 €	209,26 €	5	60	600

Precio del conjunto completo incluyendo soporte decorativo a pared. /
 Complete set price including wall decorative bracket. / Prix kit complet compris support mur décoratif.

Decotrack® Bronce / Bronze Decotrack® / Decotrack® Bronze



*El Sistema Sencillo de 30mm se sirve con 2 soportes. /
 The 30mm single set is supplied with 2 brackets. /
 Le kit simple de 30mm est fourni avec 2 supports.

U	Ø 19 REF K.19018BC	Ø 30 REF K.19007BC	Ø 19/19 REF K.19019BC	Ø 30/19 REF K.19021BC	Key	Drill	cm
1	36,44 €	46,69 €	61,37 €	67,44 €	2	10	100
1	40,64 €	54,58 €	69,77 €	79,53 €	2	16	150
1	55,75 €	62,30 €	94,24 €	106,41 €	3*	20	200
1	59,18 €	81,31 €	102,65 €	118,49 €	3	26	250
1	64,00 €	89,80 €	110,74 €	130,27 €	3	30	300
1	79,26 €	109,57 €	135,52 €	157,46 €	4	36	350
1	72,24 €	117,30 €	143,61 €	169,23 €	4	40	400
1	110,87 €	160,41 €	192,98 €	232,06 €	5	60	600

Precio del conjunto completo incluyendo soporte decorativo a pared. /
 Complete set price including wall decorative bracket. / Prix kit complet compris support mur décoratif.

Decotrack® Blanco / White Decotrack® / Decotrack® Blanc



*El Sistema Sencillo de 30mm se sirve con 2 soportes. /
 The 30mm single set is supplied with 2 brackets. /
 Le kit simple de 30mm est fourni avec 2 supports.

U	Ø 19 REF K.19018BL	Ø 30 REF K.19007BL	Ø 19/19 REF K.19019BL	Ø 30/19 REF K.19021BL	Key	Drill	cm
1	34,12 €	43,77 €	56,73 €	62,20 €	2	10	100
1	37,16 €	50,20 €	62,81 €	71,67 €	2	16	150
1	51,11 €	56,46 €	84,96 €	95,93 €	3*	20	200
1	53,38 €	74,01 €	91,05 €	105,39 €	3	26	250
1	57,04 €	81,04 €	96,82 €	114,55 €	3	30	300
1	71,14 €	99,35 €	119,28 €	139,12 €	4	36	350
1	74,03 €	105,62 €	125,05 €	148,27 €	4	40	400
1	96,95 €	142,89 €	165,14 €	200,62 €	5	60	600

Precio del conjunto completo incluyendo soporte decorativo a pared. /
 Complete set price including wall decorative bracket. / Prix kit complet compris support mur décoratif.

Instalación Decorativa "A Techo" con corredera D.07 /
 "Ceiling" decorative installation with D.07 runner /
 Option d'installation décorative à "Plafond" avec glisseur D.07



Incremento para Sistema Onda Perfecta / Price increase perfect wave system / Hausse prix système onde parfaite:
 D.111: 4,80 €/m D.112: 3,30 €/m D.113: 3,30 €/m D.114: 3,30 €/m

Decotrack® Anodizado Acero / Anodized Steel Decotrack® / Decotrack® Acier Anodisé



U	Ø 19 REF K.18718AA	Ø 30 REF K.18707AA	Ø 19/19	Ø 30/19	Ø 19 Ø 30	U	cm
1	23,37 €	31,63 €			2 2	10	100
1	28,89 €	40,65 €			2 2	16	150
1	34,24 €	52,74 €			3 2	20	200
1	42,98 €	64,21 €			4 3	26	250
1	48,33 €	73,85 €			4 3	30	300
1	57,07 €	82,87 €			4 4	36	350
1	62,41 €	94,96 €			5 4	40	400
1	87,37 €	133,95 €			6 5	60	600

Precio del conjunto completo incluyendo soporte invisible a techo. /
 Complete set price including ceiling invisible bracket. / Prix kit complet compris support plafond invisible.

Decotrack® Plata Gratada / Anodized Silver Decotrack® / Decotrack® Argent Anodisé



U	Ø 19 REF K.18718AP	Ø 30 REF K.18707AP	Ø 19/19	Ø 30/19	Ø 19 Ø 30	U	cm
1	19,27 €	27,03 €			2 2	10	100
1	22,73 €	33,75 €			2 2	16	150
1	26,04 €	43,54 €			3 2	20	200
1	32,72 €	53,48 €			4 3	26	250
1	36,03 €	60,05 €			4 3	30	300
1	42,71 €	66,77 €			4 4	36	350
1	46,01 €	76,56 €			5 4	40	400
1	62,77 €	106,35 €			6 5	60	600

Precio del conjunto completo incluyendo soporte invisible a techo. /
 Complete set price including ceiling invisible bracket. / Prix kit complet compris support plafond invisible.

Decotrack® Bronce / Bronze Decotrack® / Decotrack® Bronze



U	Ø 19 REF K.18718BC	Ø 30 REF K.18707BC	Ø 19/19	Ø 30/19	Ø 19 Ø 30	U	cm
1	20,75 €	29,35 €			2 2	10	100
1	24,95 €	37,23 €			2 2	16	150
1	29,00 €	48,18 €			3 2	20	200
1	36,42 €	59,28 €			4 3	26	250
1	40,47 €	67,01 €			4 3	30	300
1	47,89 €	74,89 €			4 4	36	350
1	51,93 €	85,84 €			5 4	40	400
1	71,65 €	120,27 €			6 5	60	600

Precio del conjunto completo incluyendo soporte invisible a techo. /
 Complete set price including ceiling invisible bracket. / Prix kit complet compris support plafond invisible.

Decotrack® Blanco / White Decotrack® / Decotrack® Blanc



U	Ø 19 REF K.18718BL	Ø 30 REF K.18707BL	Ø 19/19	Ø 30/19	Ø 19 Ø 30	U	cm
1	18,43 €	26,43 €			2 2	10	100
1	21,47 €	32,85 €			2 2	16	150
1	24,36 €	42,34 €			3 2	20	200
1	30,62 €	51,98 €			4 3	26	250
1	33,51 €	58,25 €			4 3	30	300
1	39,77 €	64,67 €			4 4	36	350
1	42,65 €	74,16 €			5 4	40	400
1	57,73 €	102,75 €			6 5	60	600

Precio del conjunto completo incluyendo soporte invisible a techo. /
 Complete set price including ceiling invisible bracket. / Prix kit complet compris support plafond invisible.

Contenido del Kit / Kit components / Composants du Kit

Conjuntos sencillos: 2 terminales Tapa, soportes (consultar tabla de conjuntos en función de la longitud del perfil), perfil, tornillo tope y correderas D.07.

Conjuntos dobles: 4 terminales, soportes (consultar tabla de conjuntos en función de la longitud del perfil), 2 perfiles, tornillo tope y correderas D.07.

En caso de querer cambiar el terminal Tapa, por cualquier otro del catálogo, especificar en el pedido el terminal deseado.

Single sets: 2 endcaps, brackets (check table depending on the length pole), profile, end screw, and runners D.07.

Double sets: 4 endcaps, brackets (check table depending on the length pole), 2 profiles, end screw, and runners D.07.

If you wish to take another finial from our catalogue, please specify it on your order.

Kits simples: 2 bouchons, supports (verifier dans la table selon la longueur du rail), rail, vis d'arrêt, et glisseurs D.07.

Kits doubles: 4 bouchons, supports (verifier dans la table selon la longueur du rail), 2 rails, vis d'arrêt, et glisseurs D.07.

Si vous voulez choisir toute autre embout de notre catalogue, veuillez préciser dans votre commande.

Otras posibilidades de montaje / Others installation possibilities / Autres possibilités de montage

 30 Ø	A TECHO ceiling installation à plafond	 N.114	
	A PARED wall installation à mur	 N.113 O.113 N.115	
 19 Ø	A TECHO ceiling installation à plafond	 N.114	 XXXXX



La colección **Decotrack®** permite múltiples opciones de personalización puesto que es compatible con los accesorios fabricados por Altran Solutions SL en 19 y 30 mm de diámetro. De este modo, al contar con Altran como proveedor habitual siempre podrás emplear nuestros terminales, soportes, correderas... según tu propio criterio. Desde Altran queremos poner en tus manos todas las soluciones posibles para que tú, como especialista y profesional de la decoración y del cortinaje, puedas realizar el diseño que realmente creas más conveniente para cada situación.

The **Decotrack®** collection allows multiple customization options since it is compatible with the accessories manufactured by Altran Solutions SL in 19 and 30mm diameter. This way, if Altran is your usual supplier you can always use our finials, brackets, runners... under your own criteria. We want to make available all the possible solutions so that you, as an expert and Professional of the decoration and the curtain, can make the design that you really find most convenient for each situation.

La collection **Decotrack®** permet de multiples options de personnalisation puisqu'elle est compatible avec les accessoires fabriqués par Altran Solutions SL en diamètre 19 et 30mm. Ainsi, si Altran est votre fournisseur habituel, vous pouvez toujours utiliser nos embouts, supports, glisseurs... selon vos propres critères. Nous voulons mettre à votre disposition toutes les solutions possibles afin que vous, en tant qu'expert et professionnel de la décoration et du rideau, puissiez faire le design que vous trouvez le plus pratique pour chaque situation.

Accesorios / Accessories / Accessoires



Perfil Decotrack®
Acero Anodizado /

Decotrack® profile
Anodized Steel /
Decotrack® profil
Acier Anodisé

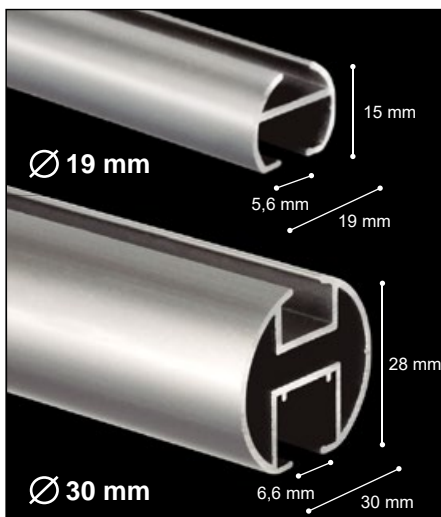

REF	∅	U	€	€ ¹	cm
C.12036AA100	19	1		10,10 €	100
C.12036AA150	19	1		15,16 €	150
C.12036AA200	19	1		20,20 €	200
C.12036AA250	19	1		25,26 €	250
C.12036AA300	19	1		30,30 €	300
C.12036AA350	19	1		35,36 €	350
C.12036AA400	19	1		40,40 €	400
C.12036AA600	19	1		60,60 €	600
C.12037AA100	30	1		17,12 €	100
C.12037AA150	30	1		25,68 €	150
C.12037AA200	30	1		34,24 €	200
C.12037AA250	30	1		42,80 €	250
C.12037AA300	30	1		51,36 €	300
C.12037AA350	30	1		59,92 €	350
C.12037AA400	30	1		68,48 €	400
C.12037AA600	30	1		102,72 €	600

NEW

Perfil Decotrack®
Plata Gratada /

Decotrack® profile
Anodized Silver /
Decotrack® profil
Argent Anodisé

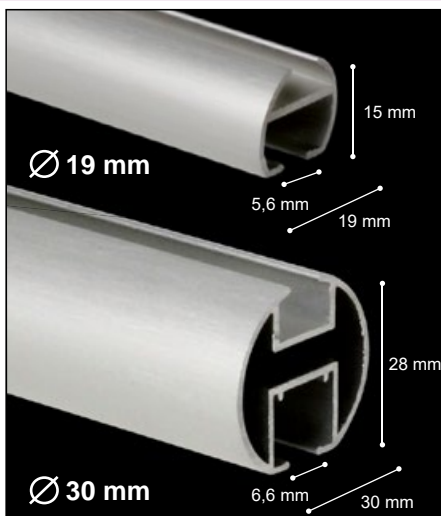

REF	∅	U	€	€ ¹	cm
C.12036AP100	19	1		6,00 €	100
C.12036AP150	19	1		9,00 €	150
C.12036AP200	19	1		12,00 €	200
C.12036AP250	19	1		15,00 €	250
C.12036AP300	19	1		18,00 €	300
C.12036AP350	19	1		21,00 €	350
C.12036AP400	19	1		24,00 €	400
C.12036AP600	19	1		36,00 €	600
C.12037AP100	30	1		12,52 €	100
C.12037AP150	30	1		18,78 €	150
C.12037AP200	30	1		25,04 €	200
C.12037AP250	30	1		31,30 €	250
C.12037AP300	30	1		37,56 €	300
C.12037AP350	30	1		43,82 €	350
C.12037AP400	30	1		50,08 €	400
C.12037AP600	30	1		75,12 €	600

NEW

Perfil Decotrack®
Bronce /

Decotrack® profile
Bronze /
Decotrack® profil
Bronze

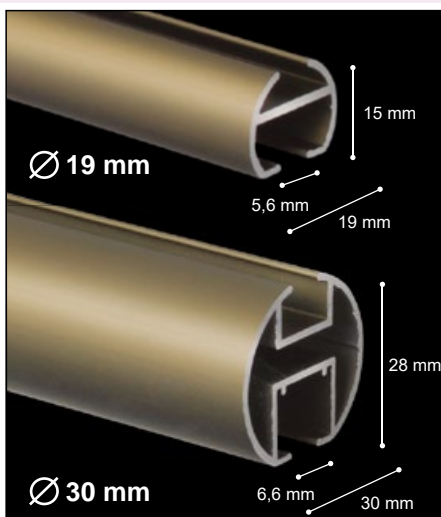

REF	∅	U	€	€ ¹	cm
C.12036BC100	19	1		7,48 €	100
C.12036BC150	19	1		11,22 €	150
C.12036BC200	19	1		14,96 €	200
C.12036BC250	19	1		18,70 €	250
C.12036BC300	19	1		22,44 €	300
C.12036BC350	19	1		26,18 €	350
C.12036BC400	19	1		29,92 €	400
C.12036BC600	19	1		44,88 €	600
C.12037BC100	30	1		14,84 €	100
C.12037BC150	30	1		22,26 €	150
C.12037BC200	30	1		29,68 €	200
C.12037BC250	30	1		37,10 €	250
C.12037BC300	30	1		44,52 €	300
C.12037BC350	30	1		51,94 €	350
C.12037BC400	30	1		59,36 €	400
C.12037BC600	30	1		89,04 €	600

NEW

Perfil Decotrack®
Blanco /

Decotrack® profile
White /
Decotrack® profil
Blanc

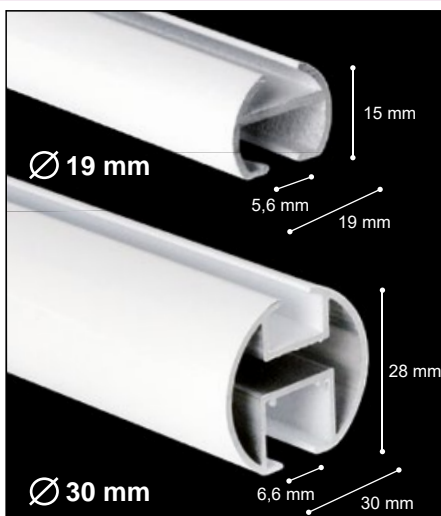

REF	∅	U	€	€ ¹	cm
C.12036BL100	19	1		5,16 €	100
C.12036BL150	19	1		7,74 €	150
C.12036BL200	19	1		10,32 €	200
C.12036BL250	19	1		12,90 €	250
C.12036BL300	19	1		15,48 €	300
C.12036BL350	19	1		18,06 €	350
C.12036BL400	19	1		20,64 €	400
C.12036BL600	19	1		30,96 €	600
C.12037BL100	30	1		11,92 €	100
C.12037BL150	30	1		17,88 €	150
C.12037BL200	30	1		23,84 €	200
C.12037BL250	30	1		29,80 €	250
C.12037BL300	30	1		35,76 €	300
C.12037BL350	30	1		41,72 €	350
C.12037BL400	30	1		47,68 €	400
C.12037BL600	30	1		71,52 €	600

NEW

Terminal Tapa
Decotrack® 19mm

Decotrack® 19mm
flat endcap /
Decotrack® 19mm
bouchon plat

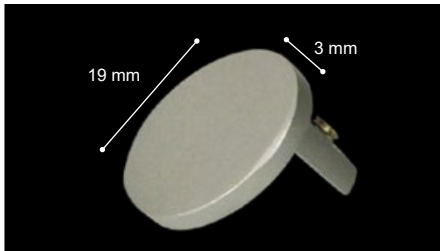

REF	∅	U	€	€	cm
P.64AA	19	25	2,40 €	2,76 €	
P.64AP	19	25	2,40 €	2,76 €	
P.64BC	19	25	2,40 €	2,76 €	
P.64BL	19	25	2,40 €	2,76 €	

NEW

Terminal Tapa
Decotrack® 30mm

Decotrack® 30mm
flat endcap /
Decotrack® 30mm
bouchon plat

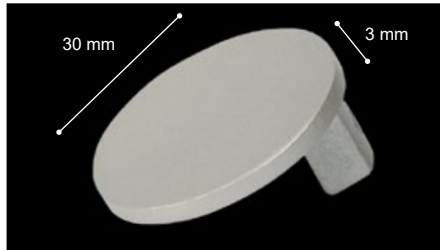

REF	∅	U	€	€	cm
P.65AA	30	25	2,94 €	3,38 €	
P.65AP	30	25	2,94 €	3,38 €	
P.65BC	30	25	2,94 €	3,38 €	
P.65BL	30	25	2,94 €	3,38 €	

NEW

Soporte Pared
19mm

Wall Brackets /
Supports Mur

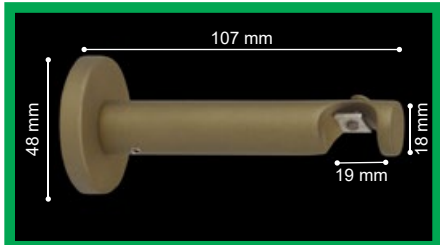

REF	∅	U	€	€	cm
A.4020AA	19	10	9,62 €	11,06 €	
A.4020AP	19	10	9,62 €	11,06 €	
A.4020BC	19	10	9,62 €	11,06 €	
A.4020BL	19	10	9,62 €	11,06 €	

NEW

* Soporte incluido en el Kit Decotrack® 19mm A Pared /

Bracket supplied in the Decotrack® 19mm Wall Kit / Support fourni dans le Decotrack® 19mm Kit Mur

Soporte Doble Pared
19/19mm

Double Wall
Bracket /
Support Mur Double

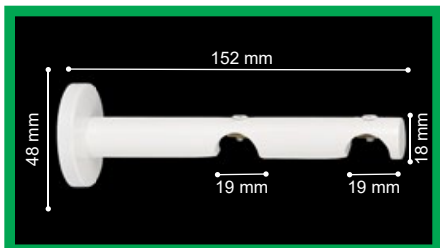

REF	∅	U	€	€	cm
A.4021AA	19/19	10	14,24 €	16,38 €	
A.4021AP	19/19	10	14,24 €	16,38 €	
A.4021BC	19/19	10	14,24 €	16,38 €	
A.4021BL	19/19	10	14,24 €	16,38 €	

NEW

* Soporte incluido en el Kit Decotrack® 19/19mm A Pared /

Bracket supplied in the Decotrack® 19/19mm Wall Kit / Support fourni dans le Decotrack® 19/19mm Kit Mur

Soporte Pared
30 mm

Wall Bracket /
Support Mur

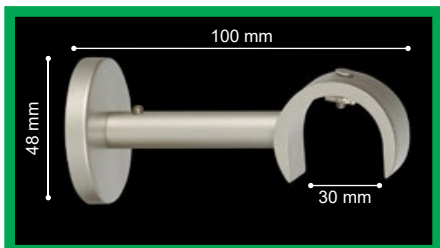

REF	∅	U	€	€	cm
A.4022AA	30	10	10,34 €	11,89 €	
A.4022AP	30	10	10,34 €	11,89 €	
A.4022BC	30	10	10,34 €	11,89 €	
A.4022BL	30	10	10,34 €	11,89 €	

NEW

* Soporte incluido en el Kit Decotrack® 30mm A Pared /

Bracket supplied in the Decotrack® 30mm Wall Kit / Support fourni dans le Decotrack® 30mm Kit Mur

Soporte Pared
30/19 mm

Double Wall
Bracket /
Support Mur Double

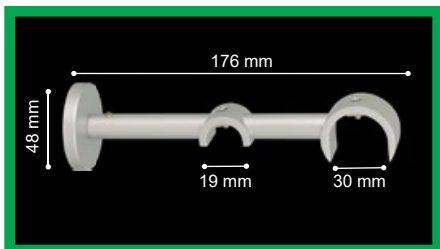

REF	∅	U	€	€	cm
A.4023AA	30/19	10	13,14 €	15,11 €	
A.4023AP	30/19	10	13,14 €	15,11 €	
A.4023BC	30/19	10	13,14 €	15,11 €	
A.4023BL	30/19	10	13,14 €	15,11 €	

NEW

* Soporte incluido en el Kit Decotrack® 30/19mm A Pared /

Bracket supplied in the Decotrack® 30/19mm Wall Kit / Support fourni dans le Decotrack® 30/19mm Kit Mur

Soporte Invisible
Plano Techo

Invisible Ceiling
Bracket /
Support Invisible
Plafond Plat

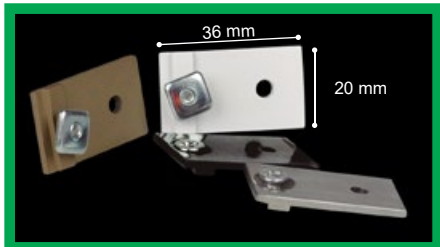

REF	∅	U	€	€	cm
N.134A		25	2,80 €	3,22 €	
N.134BC		25	2,80 €	3,22 €	
N.134BL		25	2,80 €	3,22 €	

NEW

* Soporte incluido en el Kit Decotrack® A Techo /

Bracket supplied in the Decotrack® Ceiling Kit / Support fourni dans le Decotrack® Kit Plafond

Soporte Techo
Plástico

Plastic Ceiling
Bracket /
Support Plafond
Plastique

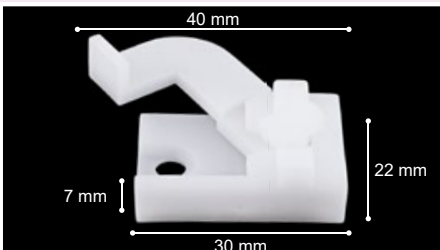

REF	∅	U	€	€	cm
N.131A		100	0,84 €	0,97 €	

Accesorios / Accessories / Accessoires



Tope

End-stop /
Vis d'arrêt



REF	∅	U	€	€ ¹	cm
D.784		10	0,226 €	0,271 €	

Corredera Tope

End-Stop Runner /
Glisseur d'arrêt



REF	∅	U	€	€ ¹	cm
D.016		100	0,58 €	0,70 €	

NEW

Rollo Cinta Acordeón con Automáticos

Ruffle-tape roll with
snap-buttons /
Rouleau ruban
accordéon avec
système automat

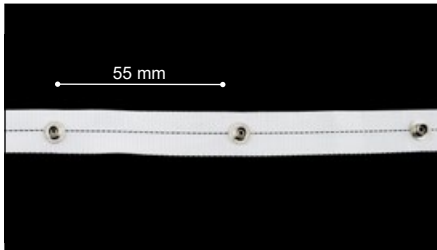

REF	∅	U	€	€ ¹	m
D.111		1	203,28 €	233,77 €	

* 1 rollo contiene 840 corchetes / Roll of 840 Snaps / Rouleau de 840 crochets.

Rollo Corredera Acordeón

Corded
gliders roll /
Rouleau glisseurs
acordeón

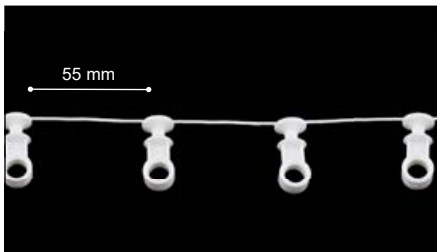

REF	∅	U	€	€ ¹	cm
D.112		1	151,20 €	173,88 €	

* 1 rollo contiene 1000 correderas / Roll of 1000 runners / Rouleau de 1000 glisseurs.

Rollo Corredera Onda Perfecta

Perfect wave
runners roll /
Rouleau de glisseur
"onde parfaite"

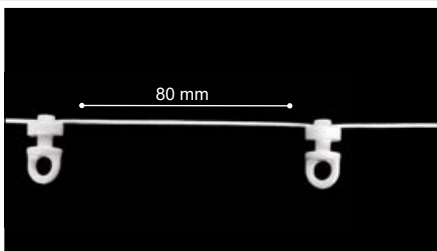

REF	∅	U	€	€ ¹	cm
D.113		1	151,20 €	173,88 €	

* 1 rollo contiene 1000 correderas / Roll of 1000 runners / Rouleau de 1000 glisseurs.

Rollo Corredera Onda Perfecta

Perfect wave
runners roll /
Rouleau de glisseur
"onde parfaite"

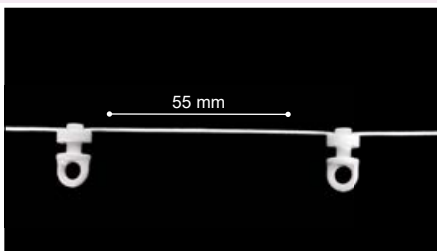

REF	∅	U	€	€ ¹	cm
D.114		1	151,20 €	173,88 €	

* 1 rollo contiene 1000 correderas / Roll of 1000 runners / Rouleau de 1000 glisseurs.

Cinta Armadora con bolsas

Buckram With
pouches /
Ruban de monter
avec pouches



Poliéster 100%
Rapport 1:2 - 4/6 Bolsas (Bags)

REF	COLOR	rollo (m) roll (m)	€	RAPPORT	mm
D.217	blanco/white	200 m	0,84 €/m		70 mm
D.217BG	beige	200 m	0,84 €/m		70 mm
D.218	blanco/white	200 m	0,98 €/m		90 mm
D.218BG	beige	200 m	0,98 €/m		90 mm
D.235TR	transparente	100 m	1,24 €/m		120 mm

Cinta Armadora Onda Perfecta 75 mm. 2 Bolsas

Perfect wave buckram
75mm 2 pockets /
Buckram onde parfaite
75mm 2 pouches

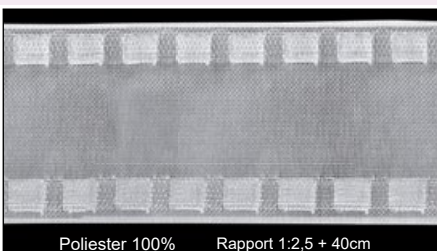

Poliéster 100% Rapport 1:2,5 + 40cm

REF	COLOR	rollo (m) roll (m)	€	RAPPORT	mm
D.230TR	transparente	100 m	1,20 €/m	1:2,5 (+40 cm)	75 mm

Caja de 1000 ganchos

Hooks Box for tape
1000 u /
Boîte de 1000
crochets
pour ruban

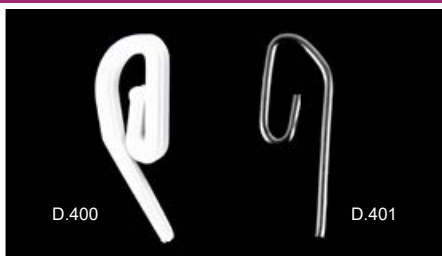

REF	∅	U	€	€	cm
D.400		1000	15,70 €		
D.401		1000	16,38 €		

Corredera

Plastic Runner /
Coulisse Plastic



REF	∅	U	€	€	cm
D.07		500	0,064 €	0,077 €	

Empalme Decotrack®
19 mm

Decotrack® splice
19 mm/
Raccordeur
19 mm Decotrack®

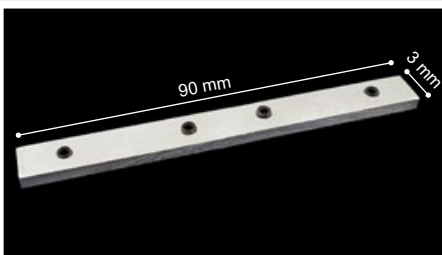

REF	∅	U	€	€	cm
H.11PL	19	10	6,68€	7,68 €	

NEW

Empalme Decotrack®
30 mm

Decotrack® splice
30 mm/
Raccordeur
30 mm Decotrack®



REF	∅	U	€	€	cm
H.05PL	30	10	7,06 €	8,12 €	

Muestra
Decotrack®

Demo Sample
Decotrack® /
Échantillon
Decotrack®

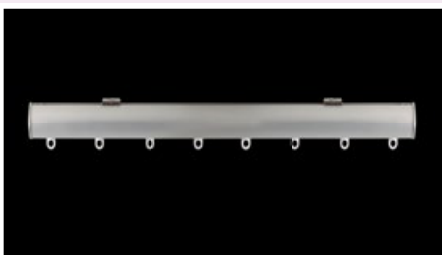

REF	∅	U	€	€	cm
M.255		1		37,08 €	

NEW



ALTRAN[®]

SISTEMAS PARA DECORAR CORTINAS

Ctra. Valencia-Ademuz Km 21,9 · Benissanó · Valencia · Spain · 46181 · (+34) 96 113 61 53 · www.altransolutions.es

BARRA DE CORTINA · ESTORES · RIELES TÉCNICOS · RIELES DECORATIVOS · GALERÍAS · SISTEMAS MOTORIZADOS
CURTAIN POLES · ROMAN BLINDS · TECHNICAL RAILS · DECORATIVE TRACKS · PELMETS · MOTORIZED SYSTEMS

REDECORA TU CASA SIN CAMBIAR NI CORTINAS NI SISTEMAS

Redecorate your home without changing the curtains nor the systems
Redécoutez votre maison sans changer les systèmes même pas les rideaux.

19&30mm
DECOTRACK[®]

Combina colores, terminales, soportes... ¡Y no cambies de sistema!
Mix and combine colours, finials, brackets... And do not change the system!
Combinez vous couleurs, embouts, supports... Et ne pas changez le système!



VETOCO
MADRID

interi
HOTEL
barcelona

Feria del
Mueble
ZARAGOZA

R+T
STUTTGART

heimtextil
FRANKFURT

interiorlifestyle
TOKYO

Opción Decorativa Sintra® Manual
Sintra® Decorative Option Manual-drawn / Option Décoratif Tirage manuel



Bronze onda perfecta Ángulos
Bronze perfect wave /
Bronze onde parfaite



Anodizado Plata Gratada onda perfecta Ángulos
Anodized silver perfect wave /
Argent anodisé onde parfaite



Bronze correderas Olas
Bronze Wheeled gliders /
Bronze Glisseurs

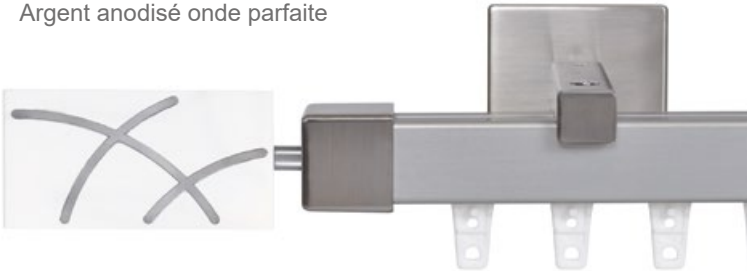

Anodizado Plata Gratada correderas Trazos
Anodized silver Wheeled gliders /
Argent anodisé Glisseurs



Negro onda perfecta Ángulos
Black perfect wave /
Noir onde parfaite



Blanco onda perfecta Ángulos
White perfect wave /
Blanc onde parfaite



Negro cinta acordeón Olas
Black ruffle tape /
Noir Ruban accordéon



Blanco cinta acordeón Trazos
White ruffle tape /
Blanc Ruban accordéon

 Riel idealado para soportar peso y sufrir situaciones de uso severas y complicadas.

La forma cuadrangular del perfil del Riel Sintra® y la calidad de su material, está diseñado expresamente para instalaciones donde se requiere un riel capaz de aguantar y deslizar (sin ningún problema), cortinas pesadas. Esta colección da solución a cualquier fórmula de montaje, tanto decorativas con soportes de acero o bronce, como funcionales con soportes de plástico para la instalación a techo de tipo riel, pudiendo desempeñar funciones de riel y de barra decorativa al mismo tiempo. Además incluye las **variantes de riel con cordón y sin cordón**.

Los terminales decorativos (novedad que hace del Riel Sintra uno de los más atractivos y deseados del mercado) tienen diseños idénticos pero asimétricos pensando en cada lado del riel. Usted podrá escoger los terminales para los conjuntos dobles, tanto para el riel interior como exterior.

 Aluminum rail with quadrangular shape, designed to hold heavy curtains and complicated installations.

The shape of the profile of the rail Sintra and the quality of its material, is designed specifically for installations where its needed a rail that holds and slides perfectly heavy curtains. This collection provides a solution to any installation so it can be used as a decorative rail and technical rail at the same time. SINTRA® rail can be used an be used with special gliders for heavy curtains but also with ripple fold wave gliders to make the "perfect wave" (our economic system that ensures a perfect fall and a perfect wave on every curtain). **Available with cord-drawn and manual-drawn.**

Its new decorative finials (that makes Sintra rail one of the most attractive of the market) have identical and asymmetrical designs for each side of the rail. You can choose the terminal for double sets also.

 La forme du profil du rail Sintra et la qualité de son matériel, est spécialement conçu pour les installations où il est nécessaire un rail qui détient et glisse parfaitement rideaux.

Cet rail offre une solution à toutes les installations, avec des supports décoratifs en couleur acier ou laiton et des supports fonctionnels comme son support en plastique pour le montage au plafond de sorte qu'il peut être utilisé comme un rail technique et décoratif en même temps. Le rail SINTRA® peut être utilisé avec des glisseurs conçues pour les rideaux lourds, mais aussi avec les glisseurs pour ruban accordéon pour faire "l'onde parfaite" (notre système économique qui assure un tombé parfaite et une onde parfaite à chaque rideau). **Disponible avec triage avec cordon ou tirage manuel.** Ses nouveaux embouts décoratifs (qui fait Sintra® un des rails plus attractifs du marché) ont des conceptions identiques et aussi asymétriques pour chaque côté du rail. Vous pouvez choisir le terminal pour les rails doubles aussi.



**Anodizado Plata Gratada
onda perfecta Tapón Manual**
Anodized silver perfect wave /
Argent anodisé onde parfaite



**Anodizado Plata Gratada
onda perfecta Tapón Cordón**
Anodized silver perfect wave /
Argent anodisé onde parfaite



Bronce corredera Tapón Manual
Bronze perfect wave /
Bronze onde parfaite

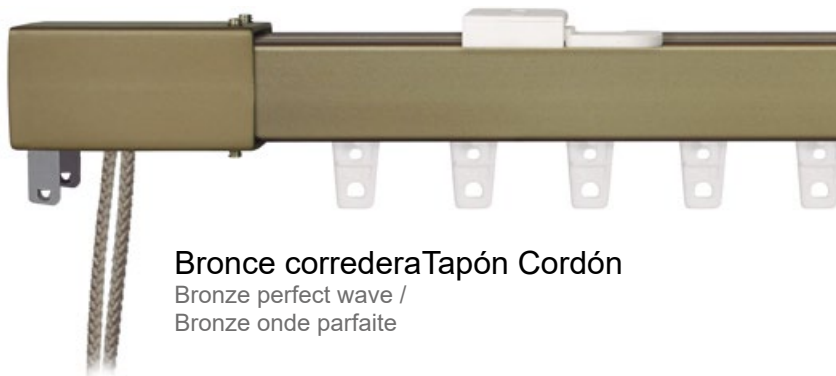

Bronce corredera Tapón Cordón
Bronze perfect wave /
Bronze onde parfaite



Blanco onda perfecta Tapón Manual
White perfect wave /
Blanc onde parfaite



Blanco onda perfecta Tapón Cordón
White perfect wave /
Blanc onde parfaite



Negro cinta acordeón Tapón Manual
Black ruffle tape /
Noir Ruban accordéon



Negro cinta acordeón Tapón Cordón
Black ruffle tape /
Noir Ruban accordéon

Accionamiento Manual / Manual-Drawn / Tirage Manuel



Conjuntos simples con accionamiento manual y soporte a pared decorativo (N.113A).
Manual-drawn single sets with wall Bracket (N.113A).
Kits simples (tirage manuel) avec support mur (N.113A).

Con Correderas / With Runners / Avec Glisseurs



REF	-AP	-BC	-BL	-NB					
K.15500100-	-AP	-BC	-BL	-NB	2	10	1	55,60 €	100
K.15500150-	-AP	-BC	-BL	-NB	2	16	1	64,21 €	150
K.15500200-	-AP	-BC	-BL	-NB	2	20	1	72,16 €	200
K.15500250-	-AP	-BC	-BL	-NB	3	26	1	94,50 €	250
K.15500300-	-AP	-BC	-BL	-NB	3	30	1	102,47 €	300
K.15500350-	-AP	-BC	-BL	-NB	3	36	1	111,06 €	350
K.15500400-	-AP	-BC	-BL	-NB	3	40	1	119,02 €	400
K.15500450-	-AP	-BC	-BL	-NB	3	46	1	127,61 €	450
K.15500500-	-AP	-BC	-BL	-NB	4	50	1	149,33 €	500
K.15500600-	-AP	-BC	-BL	-NB	4	60	1	165,89 €	600

Precio del conjunto completo incluyendo soporte decorativo a pared. /
Complete set price including wall decorative bracket. /
Prix kit complet compris support mur décoratif.

Con corredera Onda Perfecta / With Perfect Wave runner / Avec glisseur Onde Parfaite



REF	-AP	-BC	-BL	-NB					
K.15600100-	-AP	-BC	-BL	-NB	2	18*	1	55,86 €	100
K.15600150-	-AP	-BC	-BL	-NB	2	30*	1	64,28 €	150
K.15600200-	-AP	-BC	-BL	-NB	2	40*	1	72,68 €	200
K.15600250-	-AP	-BC	-BL	-NB	3	50*	1	94,83 €	250
K.15600300-	-AP	-BC	-BL	-NB	3	60*	1	103,25 €	300
K.15600350-	-AP	-BC	-BL	-NB	3	68*	1	111,65 €	350
K.15600400-	-AP	-BC	-BL	-NB	3	78*	1	120,07 €	400
K.15600450-	-AP	-BC	-BL	-NB	3	88*	1	128,47 €	450
K.15600500-	-AP	-BC	-BL	-NB	4	96*	1	150,64 €	500
K.15600600-	-AP	-BC	-BL	-NB	4	116*	1	167,46 €	600

(*) Ref. D.114 - Corredera paso 55mm / Perfect Wave Runner 55mm / Glisseur cordon 55mm
Cantidad de Correderas servidas con Apertura Central (otras opciones consultad).
Quantity of runners supplied with central opening (pls ask for further options). /
Nombre de glisseurs fournis avec ouverture central (demandez svp pour options adicionales).

Precio del conjunto completo incluyendo soporte decorativo a pared. /
Complete set price including wall decorative bracket. /
Prix kit complet compris support mur décoratif.

Con Cinta Acordeón / With Ruffle Tape / Avec Ruban Accordéon



REF	-AP	-BC	-BL	-NB					
K.15700100-	-AP	-BC	-BL	-NB	2	18*	1	61,01 €	100
K.15700150-	-AP	-BC	-BL	-NB	2	30*	1	72,00 €	150
K.15700200-	-AP	-BC	-BL	-NB	2	40*	1	82,97 €	200
K.15700250-	-AP	-BC	-BL	-NB	3	50*	1	107,69 €	250
K.15700300-	-AP	-BC	-BL	-NB	3	60*	1	118,68 €	300
K.15700350-	-AP	-BC	-BL	-NB	3	68*	1	129,65 €	350
K.15700400-	-AP	-BC	-BL	-NB	3	78*	1	140,64 €	400
K.15700450-	-AP	-BC	-BL	-NB	3	88*	1	151,61 €	450
K.15700500-	-AP	-BC	-BL	-NB	4	96*	1	176,36 €	500
K.15700600-	-AP	-BC	-BL	-NB	4	116*	1	197,85 €	600

(*) Ref. D.114 - Corredera paso 55mm / Perfect Wave Runner 55mm / Glisseur cordon 55mm
Cantidad de Correderas servidas con Apertura Central (otras opciones consultad).
Quantity of runners supplied with central opening (pls ask for further options). /
Nombre de glisseurs fournis avec ouverture central (demandez svp pour options adicionales).

Precio del conjunto completo incluyendo soporte decorativo a pared. /
Complete set price including wall decorative bracket. /
Prix kit complet compris support mur décoratif.

Accionamiento Manual /
Manual-Drawn / Tirage Manuel

Conjuntos dobles con accionamiento manual y soporte a pared decorativo (O.113A).
Manual-drawn double sets with wall Bracket (O.113A).
Kits doubles (tirage manuel) avec support mur (O.113A).

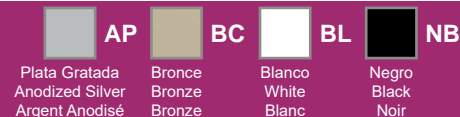

Con Correderas / With Runners / Avec Glisseurs

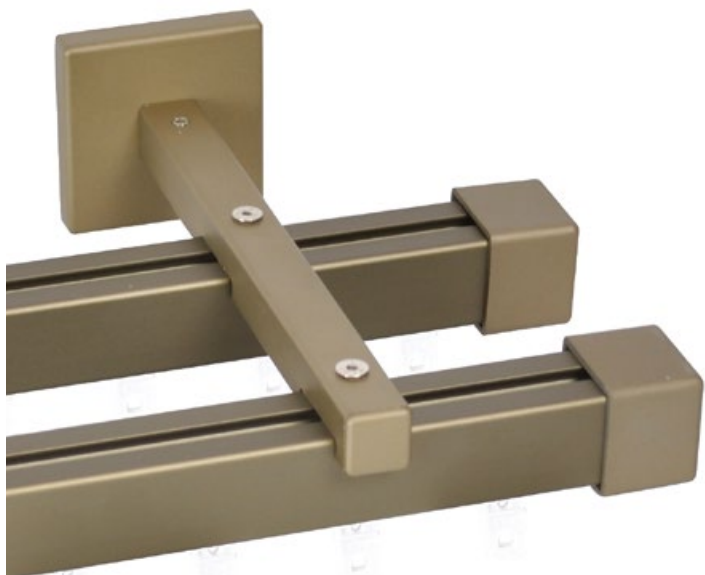

REF	-AP	-BC	-BL	-NB					
K.15522100-	-AP	-BC	-BL	-NB	2	20	1	90,36 €	100
K.15522150-	-AP	-BC	-BL	-NB	2	32	1	107,58 €	150
K.15522200-	-AP	-BC	-BL	-NB	2	40	1	123,47 €	200
K.15522250-	-AP	-BC	-BL	-NB	3	52	1	157,74 €	250
K.15522300-	-AP	-BC	-BL	-NB	3	60	1	173,68 €	300
K.15522350-	-AP	-BC	-BL	-NB	3	72	1	190,86 €	350
K.15522400-	-AP	-BC	-BL	-NB	3	80	1	206,79 €	400
K.15522450-	-AP	-BC	-BL	-NB	3	92	1	223,97 €	450
K.15522500-	-AP	-BC	-BL	-NB	4	100	1	256,99 €	500
K.15522600-	-AP	-BC	-BL	-NB	4	120	1	290,10 €	600

Precio del conjunto completo incluyendo soporte decorativo a pared. /
Complete set price including wall decorative bracket. /
Prix kit complet compris support mur décoratif.

Con corredera Onda Perfecta / With Perfect Wave runner / Avec glisseur Onde Parfaite

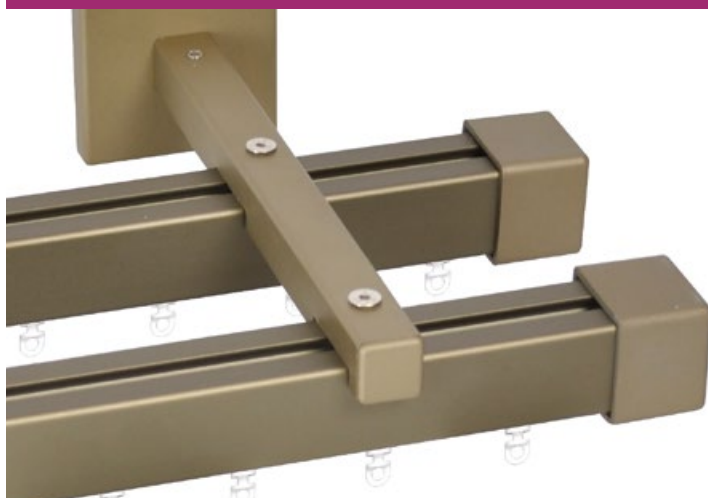

REF	-AP	-BC	-BL	-NB					
K.15622100-	-AP	-BC	-BL	-NB	2	36*	1	90,89 €	100
K.15622150-	-AP	-BC	-BL	-NB	2	60*	1	107,72 €	150
K.15622200-	-AP	-BC	-BL	-NB	2	80*	1	124,52 €	200
K.15622250-	-AP	-BC	-BL	-NB	3	100*	1	158,41 €	250
K.15622300-	-AP	-BC	-BL	-NB	3	120*	1	175,25 €	300
K.15622350-	-AP	-BC	-BL	-NB	3	136*	1	192,04 €	350
K.15622400-	-AP	-BC	-BL	-NB	3	156*	1	208,88 €	400
K.15622450-	-AP	-BC	-BL	-NB	3	176*	1	225,68 €	450
K.15622500-	-AP	-BC	-BL	-NB	4	192*	1	259,60 €	500
K.15622600-	-AP	-BC	-BL	-NB	4	232*	1	293,24 €	600

(*) Ref. D.114 - Corredera paso 55mm / Perfect Wave Runner 55mm / Glisseur cordon 55mm
Cantidad de Correderas servidas con Apertura Central (otras opciones consultad).
Quantity of runners supplied with central opening (pls ask for further options). /
Nombre de glisseurs fournis avec ouverture central (demandez svp pour options additionnelles).

Precio del conjunto completo incluyendo soporte decorativo a pared. /
Complete set price including wall decorative bracket. /
Prix kit complet compris support mur décoratif.

Con Cinta Acordeón / With Ruffle Tape / Avec Ruban Accordéon



REF	-AP	-BC	-BL	-NB					
K.15722100-	-AP	-BC	-BL	-NB	2	36*	1	101,17 €	100
K.15722150-	-AP	-BC	-BL	-NB	2	60*	1	123,15 €	150
K.15722200-	-AP	-BC	-BL	-NB	2	80*	1	145,09 €	200
K.15722250-	-AP	-BC	-BL	-NB	3	100*	1	184,12 €	250
K.15722300-	-AP	-BC	-BL	-NB	3	120*	1	206,10 €	300
K.15722350-	-AP	-BC	-BL	-NB	3	136*	1	228,04 €	350
K.15722400-	-AP	-BC	-BL	-NB	3	156*	1	250,02 €	400
K.15722450-	-AP	-BC	-BL	-NB	3	176*	1	271,97 €	450
K.15722500-	-AP	-BC	-BL	-NB	4	192*	1	311,03 €	500
K.15722600-	-AP	-BC	-BL	-NB	4	232*	1	354,96 €	600

(*) Ref. D.114 - Corredera paso 55mm / Perfect Wave Runner 55mm / Glisseur cordon 55mm
Cantidad de Correderas servidas con Apertura Central (otras opciones consultad).
Quantity of runners supplied with central opening (pls ask for further options). /
Nombre de glisseurs fournis avec ouverture central (demandez svp pour options additionnelles).

Precio del conjunto completo incluyendo soporte decorativo a pared. /
Complete set price including wall decorative bracket. /
Prix kit complet compris support mur décoratif.

Accionamiento a Cordón / Cord-Drawn / Tirage Cordon



Conjuntos sencillos con accionamiento cordón y soporte a techo (N.131A). Indicar en qué lado va el mando y la dirección de apertura.
Cord-drawn singles sets with Ceiling Bracket (N.131A). Please indicate on which side the cord is required and the opening mode.
Kits simples (tirage avec corde) avec support plafond (N.131A). Merci d'indiquer le côté de la corde et le sens d'ouverture.

Con Correderas / With Runners / Avec Glisseurs



REF	-AP	-BC	-BL	-NB					
B.16600100-	-AP	-BC	-BL	-NB	2	10	1	49,80 €	100
B.16600150-	-AP	-BC	-BL	-NB	3	16	1	59,30 €	150
B.16600200-	-AP	-BC	-BL	-NB	4	20	1	68,26 €	200
B.16600250-	-AP	-BC	-BL	-NB	4	26	1	77,76 €	250
B.16600300-	-AP	-BC	-BL	-NB	5	30	1	87,54 €	300
B.16600350-	-AP	-BC	-BL	-NB	5	36	1	97,06 €	350
B.16600400-	-AP	-BC	-BL	-NB	6	40	1	106,02 €	400
B.16600450-	-AP	-BC	-BL	-NB	6	46	1	115,54 €	450
B.16600500-	-AP	-BC	-BL	-NB	7	50	1	125,32 €	500
B.16600600-	-AP	-BC	-BL	-NB	8	60	1	143,80 €	600

Precio del conjunto completo con soporte a techo. /
Complete set price including ceiling brackets. / Prix kit complet compris support plafond.

Con corredera Onda Perfecta / With Perfect Wave runner / Avec glisseur Onde Parfaite



REF	-AP	-BC	-BL	-NB					
B.16800100-	-AP	-BC	-BL	-NB	2	18*	1	51,36 €	100
B.16800150-	-AP	-BC	-BL	-NB	3	26*	1	59,88 €	150
B.16800200-	-AP	-BC	-BL	-NB	4	38*	1	69,18 €	200
B.16800250-	-AP	-BC	-BL	-NB	4	46*	1	78,82 €	250
B.16800300-	-AP	-BC	-BL	-NB	5	58*	1	89,00 €	300
B.16800350-	-AP	-BC	-BL	-NB	5	66*	1	98,58 €	350
B.16800400-	-AP	-BC	-BL	-NB	6	74*	1	107,92 €	400
B.16800450-	-AP	-BC	-BL	-NB	6	82*	1	117,52 €	450
B.16800500-	-AP	-BC	-BL	-NB	7	96*	1	127,68 €	500
B.16800600-	-AP	-BC	-BL	-NB	8	102*	1	146,62 €	600

(*) Ref. D.114 - Corredera paso 55mm / Perfect Wave Runner 55mm / Glisseur cordon 55mm
Cantidad de Correderas servidas con Apertura Central (otras opciones consultad).
Quantity of runners supplied with central opening (pls ask for further options). /
Nombre de glisseurs fournis avec ouverture central (demandez svp pour options additionelles).

Precio del conjunto completo con soporte a techo. /
Complete set price including ceiling brackets. / Prix kit complet compris support plafond.

Con Cinta Acordeón / With Ruffle Tape / Avec Ruban Accordéon



REF	-AP	-BC	-BL	-NB					
K.16700100-	-AP	-BC	-BL	-NB	2	18*	1	52,08 €	100
K.16700150-	-AP	-BC	-BL	-NB	3	26*	1	62,74 €	150
K.16700200-	-AP	-BC	-BL	-NB	4	38*	1	72,96 €	200
K.16700250-	-AP	-BC	-BL	-NB	4	46*	1	83,64 €	250
K.16700300-	-AP	-BC	-BL	-NB	5	58*	1	94,66 €	300
K.16700350-	-AP	-BC	-BL	-NB	5	66*	1	105,32 €	350
K.16700400-	-AP	-BC	-BL	-NB	6	74*	1	115,50 €	400
K.16700450-	-AP	-BC	-BL	-NB	6	82*	1	126,14 €	450
K.16700500-	-AP	-BC	-BL	-NB	7	96*	1	137,18 €	500
K.16700600-	-AP	-BC	-BL	-NB	8	102*	1	158,06 €	600

(*) Ref. D.114 - Corredera paso 55mm / Perfect Wave Runner 55mm / Glisseur cordon 55mm
Cantidad de Correderas servidas con Apertura Central (otras opciones consultad).
Quantity of runners supplied with central opening (pls ask for further options). /
Nombre de glisseurs fournis avec ouverture central (demandez svp pour options additionelles).

Precio del conjunto completo con soporte a techo. /
Complete set price including ceiling brackets. / Prix kit complet compris support plafond.

Accionamiento a Cordón /
Cord-Drawn / Tirage Cordon



Conjuntos dobles con accionamiento cordón y soporte a techo (N.131A). Indicad en qué lado va el mando y la dirección de apertura.
Cord-drawn double sets with Ceiling Bracket (N.131A). Please indicate on which side the cord is required and the opening mode.
Kits doubles (tirage avec corde) avec support plafond (N.131A). Merci d'indiquer le côté de la corde et le sens d'ouverture.

Con Correderas / With Runners / Avec Glisseurs



REF	-AP	-BC	-BL	-NB					
B.16622100-	-AP	-BC	-BL	-NB	4	20	1	95,72 €	100
B.16622150-	-AP	-BC	-BL	-NB	6	32	1	114,28 €	150
B.16622200-	-AP	-BC	-BL	-NB	8	40	1	131,78 €	200
B.16622250-	-AP	-BC	-BL	-NB	8	52	1	150,34 €	250
B.16622300-	-AP	-BC	-BL	-NB	10	60	1	169,48 €	300
B.16622350-	-AP	-BC	-BL	-NB	10	72	1	188,06 €	350
B.16622400-	-AP	-BC	-BL	-NB	12	80	1	205,56 €	400
B.16622450-	-AP	-BC	-BL	-NB	12	92	1	224,10 €	450
B.16622500-	-AP	-BC	-BL	-NB	14	100	1	243,26 €	500
B.16622600-	-AP	-BC	-BL	-NB	16	120	1	279,34 €	600

Precio del conjunto completo con soporte a techo. /
Complete set price including ceiling brackets. / Prix kit complet compris support plafond.

Con corredera Onda Perfecta / With Perfect Wave runner / Avec glisseur Onde Parfaite



REF	-AP	-BC	-BL	-NB					
B.16822100-	-AP	-BC	-BL	-NB	4	36*	1	96,68 €	100
B.16822150-	-AP	-BC	-BL	-NB	6	52*	1	115,46 €	150
B.16822200-	-AP	-BC	-BL	-NB	8	76*	1	133,66 €	200
B.16822250-	-AP	-BC	-BL	-NB	8	92*	1	152,42 €	250
B.16822300-	-AP	-BC	-BL	-NB	10	116*	1	172,34 €	300
B.16822350-	-AP	-BC	-BL	-NB	10	132*	1	191,10 €	350
B.16822400-	-AP	-BC	-BL	-NB	12	148*	1	209,30 €	400
B.16822450-	-AP	-BC	-BL	-NB	12	164*	1	228,10 €	450
B.16822500-	-AP	-BC	-BL	-NB	14	192*	1	247,98 €	500
B.16822600-	-AP	-BC	-BL	-NB	16	204*	1	284,96 €	600

Precio del conjunto completo con soporte a techo. /
Complete set price including ceiling brackets. / Prix kit complet compris support plafond.

Con Cinta Acordeón / With Ruffle Tape / Avec Ruban Accordéon

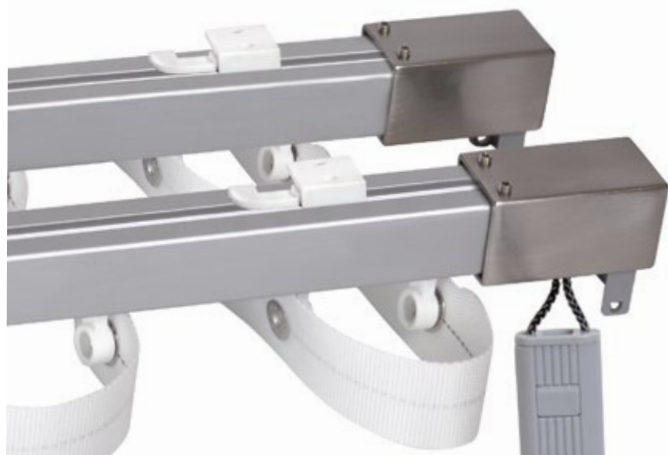

REF	-AP	-BC	-BL	-NB					
K.16722100-	-AP	-BC	-BL	-NB	4	36*	1	100,34 €	100
K.16722150-	-AP	-BC	-BL	-NB	6	52*	1	121,20 €	150
K.16722200-	-AP	-BC	-BL	-NB	8	76*	1	141,18 €	200
K.16722250-	-AP	-BC	-BL	-NB	8	92*	1	162,04 €	250
K.16722300-	-AP	-BC	-BL	-NB	10	116*	1	183,66 €	300
K.16722350-	-AP	-BC	-BL	-NB	10	132*	1	204,54 €	350
K.16722400-	-AP	-BC	-BL	-NB	12	148*	1	224,50 €	400
K.16722450-	-AP	-BC	-BL	-NB	12	164*	1	245,36 €	450
K.16722500-	-AP	-BC	-BL	-NB	14	192*	1	267,00 €	500
K.16722600-	-AP	-BC	-BL	-NB	16	204*	1	307,84 €	600

Precio del conjunto completo con soporte a techo. /
Complete set price including ceiling brackets. / Prix kit complet compris support plafond.

(*) Ref. D.114 - Corredera paso 55mm / Perfect Wave Runner 55mm / Glisseur cordon 55mm
Cantidad de Correderas servidas con Apertura Central (otras opciones consultad).
Quantity of runners supplied with central opening (pls ask for further options). /
Nombre de glisseurs fournis avec ouverture central (demandez svp pour options additionnelles).

(*) Ref. D.114 - Corredera paso 55mm / Perfect Wave Runner 55mm / Glisseur cordon 55mm
Cantidad de Correderas servidas con Apertura Central (otras opciones consultad).
Quantity of runners supplied with central opening (pls ask for further options). /
Nombre de glisseurs fournis avec ouverture central (demandez svp pour options additionnelles).

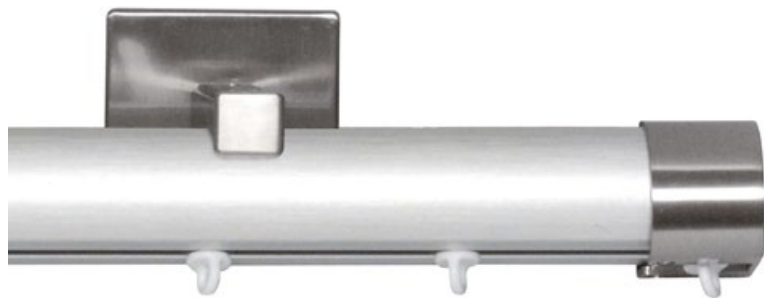

**Anodizado Plata Gratada
onda perfecta Tapón Manual**
Anodized silver perfect wave /
Argent anodisé onde parfaite



**Anodizado Plata Gratada
onda perfecta Tapón Cordón**
Anodized silver perfect wave /
Argent anodisé onde parfaite



Bronze corredera Tapón Manual
Bronze perfect wave /
Bronze onde parfaite



Bronze corredera Tapón Cordón
Bronze perfect wave /
Bronze onde parfaite



Blanco onda perfecta Tapón Manual
White perfect wave /
Blanc onde parfaite



Blanco onda perfecta Tapón Cordón
White perfect wave /
Blanc onde parfaite



Negro cinta acordeón Tapón Manual
Black ruffle tape /
Noir Ruban accordéon



Negro cinta acordeón Tapón Cordón
Black ruffle tape /
Noir Ruban accordéon

El Riel **OBIDOS®** está diseñado y patentado por Altran pensando en beneficiar a las empresas de decoración y de instalación de sistemas para decorar ventanas y a los profesionales del cortinaje. Los rieles decorativos Obidos®, Coimbra® y Sintra®, tienen accesorios compatibles entre sí, por lo que en cada situación se podrá optar por una opción u otra sin tener que almacenar múltiples piezas de diferentes perfiles. El Riel Obidos® está fabricado en aluminio y ha sido tratado para deslizar mejor y reducir el ruido. Soporta hasta **6 kg/m** y puede ser instalado a **Techo**, a **Pared** e incluso con soporte **Sencillo y Doble**. Dispone de la opción **Manual y a Cordón**. Permite la confección de cortinas con diferentes **sistemas, los tradicionales** pero también la **Onda Perfecta o la Onda Confort**. Además se puede realizar cualquier tipo de Apertura. Por último, Altran ofrece **2 años de garantía** en el aluminio y en los sistemas.

The Obidos® track is designed and patented by Altran aiming at making things easier to the companies and professionals dealing with the decoration of the window and curtains. In fact, our decorative tracks Obidos®, Coimbra® and Sintra® have the same accessories, fully compatible with the 3 systems. This will permit to use a different system without the need of having their own exclusive accessories. The Obidos® track is made of aluminium and it has been coated for a better sliding and less noisy performance. It can stand up to 6 kg/m and can be installed to wall or ceiling, even with a single or double bracket option. Supplied in manual or corded versions. Regarding the making of the curtain, it can be made with the traditional standard runner and also with the perfect and confort wave runner system. In addition, client can ask for any opening mode. Altran offers 2 years guarantee in the aluminium systems.

Le système Obidos® est conçu et breveté par Altran visant à rendre les choses plus faciles aux entreprises et aux professionnels de la décoration de la fenêtre et les rideaux. En fait, nos rails décoratifs Obidos®, Coimbra® et Sintra® ont les mêmes accessoires, entièrement compatibles avec les 3 systèmes. Cela permettra d'utiliser un autre système sans qu'il soit nécessaire d'avoir leurs propres accessoires exclusifs. Le rail Obidos® est fait d'aluminium et il a été revêtu pour une meilleure performance de glissement, moins bruyant. Il peut supporter jusqu'à 6 kg / m et peut être installé au mur ou au plafond, même avec support simple ou double. Livré en version manuelle ou avec cordon. En ce qui concerne la confection du rideau, il peut être fait avec des glisseurs standards traditionnelles et aussi avec le système d'onde parfaite et confort. Le client peut aussi demander tout mode d'ouverture. Altran offre 2 ans de garantie dans les systèmes en aluminium.

Riel Coimbra®: Manual y Cordón / Coimbra Track®: Cord and Hand-drawn / Rail Coimbra® Tirage Cordon et Manuel

Perfil con 2 Opciones: Ovalado y Plano.
Profile with 2 Options: Oval and Plain.
Profile avec 2 Options: Oval et Lisse.



Anodizado Plata Gratada
onda perfecta Tapón Manual
Anodized silver perfect wave /
Argent anodisé onde parfaite



Bronze corredera Tapón Manual
Bronze perfect wave /
Bronze onde parfaite



Blanco onda perfecta Tapón Manual
White perfect wave /
Blanc onde parfaite



Negro cinta acordeón Tapón Manual
Black ruffle tape /
Noir Ruban accordéon



Anodizado Plata Gratada
onda perfecta Tapón Cordón
Anodized silver perfect wave /
Argent anodisé onde parfaite



Bronze corredera Tapón Cordón
Bronze perfect wave /
Bronze onde parfaite



Blanco onda perfecta Tapón Cordón
White perfect wave /
Blanc onde parfaite



Negro cinta acordeón Tapón Cordón
Black ruffle tape /
Noir Ruban accordéon

Las características del Riel Obidos®, Coimbra® y Sintra® presentan las mismas ventajas.

Sólo se diferencian en la forma del perfil de aluminio. Mientras que el Riel Sintra® es cuadrado, el Riel Obidos® es cilíndrico sin embargo la gran diferencia reside en que el Riel Coimbra® son 2 rieles en 1. Por un lado es plano, pero si le damos la vuelta por el otro lado, su forma es curvada. Esto supone una opción más para ofertar por parte del decorador a sus clientes sin que esta ventaja suponga un aumento de precio.

Los tres rieles, Sintra®, Obidos® y Coimbra®, permiten que la confección de las cortinas llegue hasta el extremo del riel pues dispone de tapas especiales para Cordón que permiten el uso completo del carril.

Sin duda estos rieles se han convertido en la colección de rieles decorativos más notable entre decoradores y confeccionistas debido a sus opciones de montaje, su facilidad de instalación, los múltiples accesorios y por su puesto por la compatibilidad entre ellos.

The Obidos®, Coimbra® and Sintra® tracks have all the same advantages.

The only difference is the shape of each rail itself. Sintra® is square, Obidos® is cylindrical and regarding the third system, the Coimbra®, we must emphasize its double use for the double shape it has, plain in one side and curved in the other, making this a price advantage when offering this system to the clients.

The three systems permit a total best use of the curtain since the side endcaps are supplied with a fixing system that allows the curtain reach both ends of the rail.

Surely, these systems have become the most preferred option for Decorators and Curtain-makers due to their several assembly options, easy installation, multiple accessories and its explained remarkable compatibility.

Les rails Obidos®, Coimbra® et Sintra® ont tous les mêmes avantages.

La seule différence est la forme de chaque rail lui-même. Sintra® est carré, Obidos® est cylindrique et en ce qui concerne le troisième système, le Coimbra®, il faut souligner sa double utilisation pour la double forme, d'un côté plat et courbé dans l'autre, ce qui en fait un avantage de prix lorsqu'ils offrent ce système à la clients.

Les trois systèmes permettent une meilleure utilisation totale du rideau parce que les embouts latéraux sont équipés d'un système de fixation qui permet au rideau atteindre les deux extrémités du rail.

Sûrement, ces systèmes sont devenus l'option la plus pratique pour Décorateurs et Confectionneurs de rideaux en raison de leurs différentes options de montage, installation facile, accessoires multiples et la déjà expliqué compatibilité remarquable.

Accionamiento Manual / Manual-Drawn / Tirage Manuel

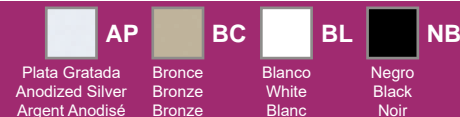

Conjuntos simples con accionamiento manual y soporte a pared decorativo (N.113A).
Manual-drawn single sets with wall Bracket (N.113A).
Kits simples (tirage manuel) avec support mur (N.113A).

Con Correderas / With Runners / Avec Glisseurs



REF	-AP	-BC	-BL	-NB					
K.14000100-	-AP	-BC	-BL	-NB	2	10	1	64,33 €	100
K.14000150-	-AP	-BC	-BL	-NB	2	16	1	75,94 €	150
K.14000200-	-AP	-BC	-BL	-NB	2	20	1	86,91 €	200
K.14000250-	-AP	-BC	-BL	-NB	3	26	1	112,27 €	250
K.14000300-	-AP	-BC	-BL	-NB	3	30	1	123,24 €	300
K.14000350-	-AP	-BC	-BL	-NB	3	36	1	134,85 €	350
K.14000400-	-AP	-BC	-BL	-NB	3	40	1	145,82 €	400
K.14000450-	-AP	-BC	-BL	-NB	3	46	1	157,43 €	450
K.14000500-	-AP	-BC	-BL	-NB	4	50	1	182,17 €	500
K.14000600-	-AP	-BC	-BL	-NB	4	60	1	204,74 €	600

Precio del conjunto completo incluyendo soporte decorativo a pared. /
Complete set price including wall decorative bracket. /
Prix kit complet compris support mur décoratif.

Con corredera Onda Perfecta / With Perfect Wave runner / Avec glisseur Onde Parfaite

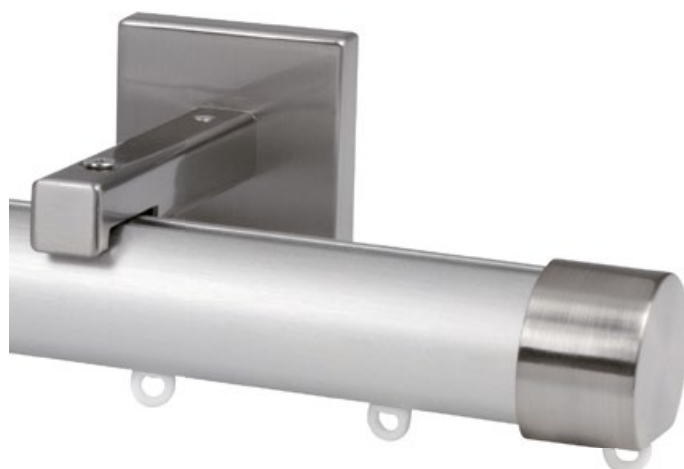

REF	-AP	-BC	-BL	-NB					
K.14100100-	-AP	-BC	-BL	-NB	2	18*	1	64,60 €	100
K.14100150-	-AP	-BC	-BL	-NB	2	30*	1	76,01 €	150
K.14100200-	-AP	-BC	-BL	-NB	2	40*	1	87,43 €	200
K.14100250-	-AP	-BC	-BL	-NB	3	50*	1	112,61 €	250
K.14100300-	-AP	-BC	-BL	-NB	3	60*	1	124,03 €	300
K.14100350-	-AP	-BC	-BL	-NB	3	68*	1	135,44 €	350
K.14100400-	-AP	-BC	-BL	-NB	3	78*	1	146,86 €	400
K.14100450-	-AP	-BC	-BL	-NB	3	88*	1	158,28 €	450
K.14100500-	-AP	-BC	-BL	-NB	4	96*	1	183,47 €	500
K.14100600-	-AP	-BC	-BL	-NB	4	116*	1	206,31 €	600

(*) Ref. D.114 - Corredera paso 55mm / Perfect Wave Runner 55mm / Glisseur cordon 55mm
Cantidad de Correderas servidas con Apertura Central (otras opciones consultad).
Quantity of runners supplied with central opening (pls ask for further options). /
Nombre de glisseurs fournis avec ouverture central (demandez svp pour options additionnelles).

Precio del conjunto completo incluyendo soporte decorativo a pared. /
Complete set price including wall decorative bracket. /
Prix kit complet compris support mur décoratif.

Con Cinta Acordeón / With Ruffle Tape / Avec Ruban Accordéon



REF	-AP	-BC	-BL	-NB					
K.14200100-	-AP	-BC	-BL	-NB	2	18*	1	69,74 €	100
K.14200150-	-AP	-BC	-BL	-NB	2	30*	1	83,73 €	150
K.14200200-	-AP	-BC	-BL	-NB	2	40*	1	97,72 €	200
K.14200250-	-AP	-BC	-BL	-NB	3	50*	1	125,46 €	250
K.14200300-	-AP	-BC	-BL	-NB	3	60*	1	139,45 €	300
K.14200350-	-AP	-BC	-BL	-NB	3	68*	1	153,44 €	350
K.14200400-	-AP	-BC	-BL	-NB	3	78*	1	167,43 €	400
K.14200450-	-AP	-BC	-BL	-NB	3	88*	1	181,43 €	450
K.14200500-	-AP	-BC	-BL	-NB	4	96*	1	209,19 €	500
K.14200600-	-AP	-BC	-BL	-NB	4	116*	1	236,70 €	600

(*) Ref. D.114 - Corredera paso 55mm / Perfect Wave Runner 55mm / Glisseur cordon 55mm
Cantidad de Correderas servidas con Apertura Central (otras opciones consultad).
Quantity of runners supplied with central opening (pls ask for further options). /
Nombre de glisseurs fournis avec ouverture central (demandez svp pour options additionnelles).

Precio del conjunto completo incluyendo soporte decorativo a pared. /
Complete set price including wall decorative bracket. /
Prix kit complet compris support mur décoratif.

Accionamiento A Cordón /
Cord-Drawn / Tirage Cordon



Conjuntos sencillos con accionamiento cordón y soporte a techo (N.131A).
Cord-drawn singles sets with Ceiling Bracket (N.131A).
Kits simples (tirage avec corde) avec support plafond (N.131A).

Indicar en qué lado va el mando y la dirección de apertura.
Pls indicate on which side the cord is required and the opening mode.
Merci d'indiquer le côté de la corde et le sens d'ouverture.

Con Correderas / With Runners / Avec Glisseurs



REF	-AP	-BC	-BL	-NB					
K.14300100-	-AP	-BC	-BL	-NB	2	10	1	62,76 €	100
K.14300150-	-AP	-BC	-BL	-NB	2	16	1	74,98 €	150
K.14300200-	-AP	-BC	-BL	-NB	2	20	1	85,90 €	200
K.14300250-	-AP	-BC	-BL	-NB	3	26	1	98,64 €	250
K.14300300-	-AP	-BC	-BL	-NB	3	30	1	110,24 €	300
K.14300350-	-AP	-BC	-BL	-NB	3	36	1	122,44 €	350
K.14300400-	-AP	-BC	-BL	-NB	3	40	1	133,64 €	400
K.14300450-	-AP	-BC	-BL	-NB	3	46	1	145,16 €	450
K.14300500-	-AP	-BC	-BL	-NB	4	50	1	157,70 €	500
K.14300600-	-AP	-BC	-BL	-NB	4	60	1	181,10 €	600

Precio del conjunto completo con soporte a techo. /
Complete set price including ceiling brackets. / Prix kit complet compris support plafond.

Con corredera Onda Perfecta / With Perfect Wave runner / Avec glisseur Onde Parfaite



REF	-AP	-BC	-BL	-NB					
K.14400100-	-AP	-BC	-BL	-NB	2	18*	1	54,68 €	100
K.14400150-	-AP	-BC	-BL	-NB	2	26*	1	66,70 €	150
K.14400200-	-AP	-BC	-BL	-NB	2	38*	1	78,08 €	200
K.14400250-	-AP	-BC	-BL	-NB	3	46*	1	90,62 €	250
K.14400300-	-AP	-BC	-BL	-NB	3	58*	1	102,68 €	300
K.14400350-	-AP	-BC	-BL	-NB	3	66*	1	114,70 €	350
K.14400400-	-AP	-BC	-BL	-NB	3	74*	1	126,32 €	400
K.14400450-	-AP	-BC	-BL	-NB	3	82*	1	137,68 €	450
K.14400500-	-AP	-BC	-BL	-NB	4	96*	1	150,64 €	500
K.14400600-	-AP	-BC	-BL	-NB	4	102*	1	174,30 €	600

Precio del conjunto completo con soporte a techo. /
Complete set price including ceiling brackets. / Prix kit complet compris support plafond.

Con Cinta Acordeón / With Ruffle Tape / Avec Ruban Accordéon



REF	-AP	-BC	-BL	-NB					
K.14500100-	-AP	-BC	-BL	-NB	2	18*	1	58,54 €	100
K.14500150-	-AP	-BC	-BL	-NB	2	26*	1	72,52 €	150
K.14500200-	-AP	-BC	-BL	-NB	2	38*	1	85,80 €	200
K.14500250-	-AP	-BC	-BL	-NB	3	46*	1	100,28 €	250
K.14500300-	-AP	-BC	-BL	-NB	3	58*	1	114,24 €	300
K.14500350-	-AP	-BC	-BL	-NB	3	66*	1	128,22 €	350
K.14500400-	-AP	-BC	-BL	-NB	3	74*	1	141,48 €	400
K.14500450-	-AP	-BC	-BL	-NB	3	82*	1	155,06 €	450
K.14500500-	-AP	-BC	-BL	-NB	4	96*	1	169,96 €	500
K.14500600-	-AP	-BC	-BL	-NB	4	102*	1	197,10 €	600

Precio del conjunto completo con soporte a techo. /
Complete set price including ceiling brackets. / Prix kit complet compris support plafond.

(*) Ref. D.114 - Corredera paso 55mm / Perfect Wave Runner 55mm / Glisseur cordon 55mm
Cantidad de Correderas servidas con Apertura Central (otras opciones consultad).
Quantity of runners supplied with central opening (pls ask for further options). /
Nombre de glisseurs fournis avec ouverture central (demandez svp pour options additionnelles).

(*) Ref. D.114 - Corredera paso 55mm / Perfect Wave Runner 55mm / Glisseur cordon 55mm
Cantidad de Correderas servidas con Apertura Central (otras opciones consultad).
Quantity of runners supplied with central opening (pls ask for further options). /
Nombre de glisseurs fournis avec ouverture central (demandez svp pour options additionnelles).

Accionamiento Manual / Manual-Drawn / Tirage Manuel



Conjuntos simples con accionamiento manual y soporte a pared decorativo (N.113A).
Manual-drawn single sets with wall Bracket (N.113A).
Kits simples (tirage manuel) avec support mur (N.113A).

Con Correderas / With Runners / Avec Glisseurs

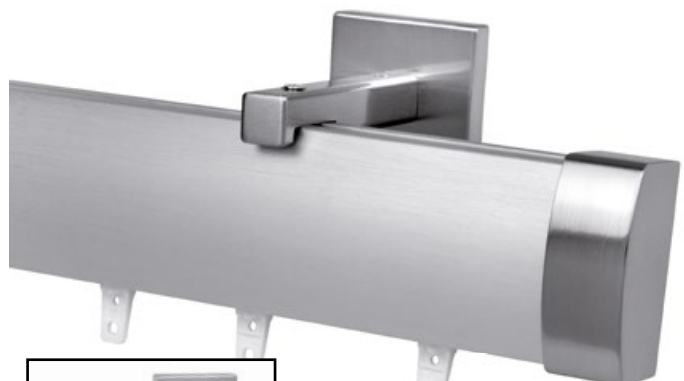

Perfil con 2 Opciones: Ovalado y Plano. Se sirve por el lado ovalado. Si se quiere el lado plano hay que especificarlo en el pedido. / Profile with 2 Options: Oval and Flat. Frontal oval side seen. Please specify if you want the plain side in front. / Profile avec 2 Options: Oval et Plat. Partie ovale vue. À spécifier si vous voulez vue la partie plate.

REF	-AP	-BC	-BL	-NB					
K.14900100-	-AP	-BC	-BL	-NB	2	10	1	74,12 €	100
K.14900150-	-AP	-BC	-BL	-NB	2	16	1	88,93 €	150
K.14900200-	-AP	-BC	-BL	-NB	2	20	1	103,09 €	200
K.14900250-	-AP	-BC	-BL	-NB	3	26	1	131,64 €	250
K.14900300-	-AP	-BC	-BL	-NB	3	30	1	145,80 €	300
K.14900350-	-AP	-BC	-BL	-NB	3	36	1	160,61 €	350
K.14900400-	-AP	-BC	-BL	-NB	3	40	1	174,78 €	400
K.14900450-	-AP	-BC	-BL	-NB	3	46	1	189,57 €	450
K.14900500-	-AP	-BC	-BL	-NB	4	50	1	217,49 €	500
K.14900600-	-AP	-BC	-BL	-NB	4	60	1	246,47 €	600

Precio del conjunto completo incluyendo soporte decorativo a pared. / Complete set price including wall decorative bracket. / Prix kit complet compris support mur décoratif.

Con corredera Onda Perfecta / With Perfect Wave runner / Avec glisseur Onde Parfaite



Perfil con 2 Opciones: Ovalado y Plano. Se sirve por el lado ovalado. Si se quiere el lado plano hay que especificarlo en el pedido. / Profile with 2 Options: Oval and Flat. Frontal oval side seen. Please specify if you want the plain side in front. / Profile avec 2 Options: Oval et Plat. Partie ovale vue. À spécifier si vous voulez vue la partie plate.

(*) Ref: D.114 - Corredera paso 55mm / Perfect Wave Runner 55mm / Glisseur cordon 55mm
Cantidad de Correderas servidas con Apertura Central (otras opciones consultad).
Quantity of runners supplied with central opening (pls ask for further options). /
Nombre de glisseurs fournis avec ouverture central (demandez svp pour options additionelles).

REF	-AP	-BC	-BL	-NB					
K.15000100-	-AP	-BC	-BL	-NB	2	18*	1	74,38 €	100
K.15000150-	-AP	-BC	-BL	-NB	2	30*	1	89,00 €	150
K.15000200-	-AP	-BC	-BL	-NB	2	40*	1	103,62 €	200
K.15000250-	-AP	-BC	-BL	-NB	3	50*	1	131,97 €	250
K.15000300-	-AP	-BC	-BL	-NB	3	60*	1	146,59 €	300
K.15000350-	-AP	-BC	-BL	-NB	3	68*	1	161,21 €	350
K.15000400-	-AP	-BC	-BL	-NB	3	78*	1	175,83 €	400
K.15000450-	-AP	-BC	-BL	-NB	3	88*	1	190,43 €	450
K.15000500-	-AP	-BC	-BL	-NB	4	96*	1	218,80 €	500
K.145000600-	-AP	-BC	-BL	-NB	4	116*	1	248,04 €	600

Precio del conjunto completo incluyendo soporte decorativo a pared. / Complete set price including wall decorative bracket. / Prix kit complet compris support mur décoratif.

Con Cinta Acordeón / With Ruffle Tape / Avec Ruban Accordéon

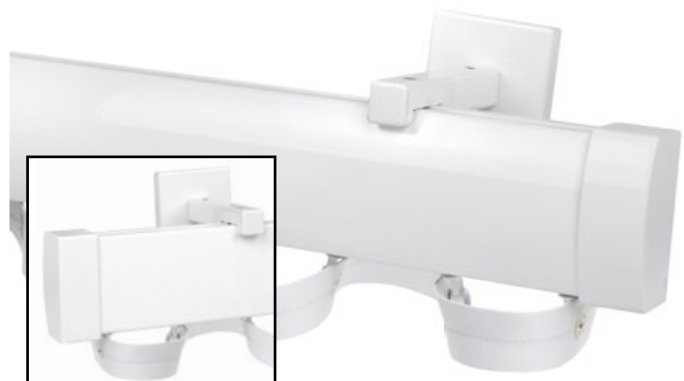

Perfil con 2 Opciones: Ovalado y Plano. Se sirve por el lado ovalado. Si se quiere el lado plano hay que especificarlo en el pedido. / Profile with 2 Options: Oval and Flat. Frontal oval side seen. Please specify if you want the plain side in front. / Profile avec 2 Options: Oval et Plat. Partie ovale vue. À spécifier si vous voulez vue la partie plate.

(*) Ref: D.114 - Corredera paso 55mm / Perfect Wave Runner 55mm / Glisseur cordon 55mm
Cantidad de Correderas servidas con Apertura Central (otras opciones consultad).
Quantity of runners supplied with central opening (pls ask for further options). /
Nombre de glisseurs fournis avec ouverture central (demandez svp pour options additionelles).

REF	-AP	-BC	-BL	-NB					
K.15100100-	-AP	-BC	-BL	-NB	2	18*	1	79,52 €	100
K.15100150-	-AP	-BC	-BL	-NB	2	30*	1	96,71 €	150
K.15100200-	-AP	-BC	-BL	-NB	2	40*	1	113,90 €	200
K.15100250-	-AP	-BC	-BL	-NB	3	50*	1	144,83 €	250
K.15100300-	-AP	-BC	-BL	-NB	3	60*	1	162,02 €	300
K.15100350-	-AP	-BC	-BL	-NB	3	68*	1	179,21 €	350
K.15100400-	-AP	-BC	-BL	-NB	3	78*	1	196,40 €	400
K.15100450-	-AP	-BC	-BL	-NB	3	88*	1	213,57 €	450
K.15100500-	-AP	-BC	-BL	-NB	4	96*	1	244,51 €	500
K.15100600-	-AP	-BC	-BL	-NB	4	116*	1	278,43 €	600

Precio del conjunto completo incluyendo soporte decorativo a pared. / Complete set price including wall decorative bracket. / Prix kit complet compris support mur décoratif.

Accionamiento A Cordón / Cord-Drawn / Tirage Cordon



Conjuntos sencillos con accionamiento cordón y soporte a techo (N.131A).
Cord-drawn singles sets with Ceiling Bracket (N.131A).
Kits simples (tirage avec corde) avec support plafond (N.131A).

Indicar en qué lado va el mando y la dirección de apertura.
Pls indicate on which side the cord is required and the opening mode.
Merci d'indiquer le côté de la corde et le sens d'ouverture.

Con Correderas / With Runners / Avec Glisseurs



Perfil con 2 Opciones: Ovalado y Plano.
Se sirve por el lado ovalado. Si se quiere el lado plano hay que especificarlo en el pedido.
Profile with 2 Options: Oval and Flat.
Frontal oval side seen. Please specify if you want the plain side in front.
Profile avec 2 Options: Oval et Plat.
Partie ovale vue. À spécifier si vous voulez vue la partie plate.

REF	-AP	-BC	-BL	-NB					
K.15200100-	-AP	-BC	-BL	-NB	2	10	1	71,28 €	100
K.15200150-	-AP	-BC	-BL	-NB	2	16	1	86,70 €	150
K.15200200-	-AP	-BC	-BL	-NB	2	20	1	100,80 €	200
K.15200250-	-AP	-BC	-BL	-NB	3	26	1	116,74 €	250
K.15200300-	-AP	-BC	-BL	-NB	3	30	1	131,52 €	300
K.15200350-	-AP	-BC	-BL	-NB	3	36	1	146,94 €	350
K.15200400-	-AP	-BC	-BL	-NB	3	40	1	161,30 €	400
K.15200450-	-AP	-BC	-BL	-NB	3	46	1	176,02 €	450
K.15200500-	-AP	-BC	-BL	-NB	4	50	1	191,76 €	500
K.15200600-	-AP	-BC	-BL	-NB	4	60	1	221,54 €	600

Precio del conjunto completo con soporte a techo. /
Complete set price including ceiling brackets. / Prix kit complet compris support plafond.

Con corredera Onda Perfecta / With Perfect Wave runner / Avec glisseur Onde Parfaite

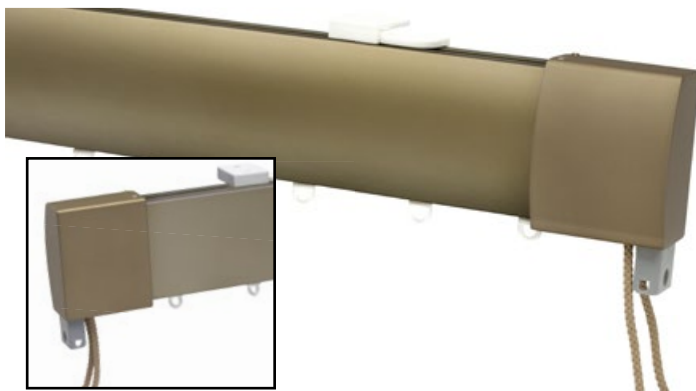

Perfil con 2 Opciones: Ovalado y Plano. Se sirve por el lado ovalado. Si se quiere el lado plano hay que especificarlo en el pedido.
Profile with 2 Options: Oval and Flat.
Frontal oval side seen. Please specify if you want the plain side in front.
Profile avec 2 Options: Oval et Plat. Partie ovale vue. À spécifier si vous voulez vue la partie plate.

(*) Ref. D.114 - Corredera paso 55mm / Perfect Wave Runner 55mm / Glisseur cordon 55mm
Cantidad de Correderas servidas con Apertura Central (otras opciones consultad).
Quantity of runners supplied with central opening (pls ask for further options). /
Nombre de glisseurs fournis avec ouverture central (demandez svp pour options additionnelles).

REF	-AP	-BC	-BL	-NB					
K.15300100-	-AP	-BC	-BL	-NB	2	18*	1	66,32 €	100
K.15300150-	-AP	-BC	-BL	-NB	2	26*	1	76,46 €	150
K.15300200-	-AP	-BC	-BL	-NB	2	38*	1	90,66 €	200
K.15300250-	-AP	-BC	-BL	-NB	3	46*	1	106,66 €	250
K.15300300-	-AP	-BC	-BL	-NB	3	58*	1	121,54 €	300
K.15300350-	-AP	-BC	-BL	-NB	3	66*	1	137,04 €	350
K.15300400-	-AP	-BC	-BL	-NB	3	74*	1	151,50 €	400
K.15300450-	-AP	-BC	-BL	-NB	3	82*	1	166,30 €	450
K.15300500-	-AP	-BC	-BL	-NB	4	96*	1	182,12 €	500
K.15300600-	-AP	-BC	-BL	-NB	4	102*	1	212,08 €	600

Precio del conjunto completo con soporte a techo. /
Complete set price including ceiling brackets. / Prix kit complet compris support plafond.

Con Cinta Acordeón / With Ruffle Tape / Avec Ruban Accordéon



Perfil con 2 Opciones: Ovalado y Plano. Se sirve por el lado ovalado. Si se quiere el lado plano hay que especificarlo en el pedido.
Profile with 2 Options: Oval and Flat.
Frontal oval side seen. Please specify if you want the plain side in front.
Profile avec 2 Options: Oval et Plat. Partie ovale vue. À spécifier si vous voulez vue la partie plate.

(*) Ref. D.114 - Corredera paso 55mm / Perfect Wave Runner 55mm / Glisseur cordon 55mm
Cantidad de Correderas servidas con Apertura Central (otras opciones consultad).
Quantity of runners supplied with central opening (pls ask for further options). /
Nombre de glisseurs fournis avec ouverture central (demandez svp pour options additionnelles).

REF	-AP	-BC	-BL	-NB					
K.15400100-	-AP	-BC	-BL	-NB	2	18*	1	67,04 €	100
K.15400150-	-AP	-BC	-BL	-NB	2	26*	1	84,20 €	150
K.15400200-	-AP	-BC	-BL	-NB	2	38*	1	100,68 €	200
K.15400250-	-AP	-BC	-BL	-NB	3	46*	1	118,38 €	250
K.15400300-	-AP	-BC	-BL	-NB	3	58*	1	135,54 €	300
K.15400350-	-AP	-BC	-BL	-NB	3	66*	1	152,70 €	350
K.15400400-	-AP	-BC	-BL	-NB	3	74*	1	169,44 €	400
K.15400450-	-AP	-BC	-BL	-NB	3	82*	1	185,92 €	450
K.15400500-	-AP	-BC	-BL	-NB	4	96*	1	204,04 €	500
K.15400600-	-AP	-BC	-BL	-NB	4	102*	1	237,54 €	600

Precio del conjunto completo con soporte a techo. /
Complete set price including ceiling brackets. / Prix kit complet compris support plafond.

Trazos
Sintra Fial /
Embout Sintra

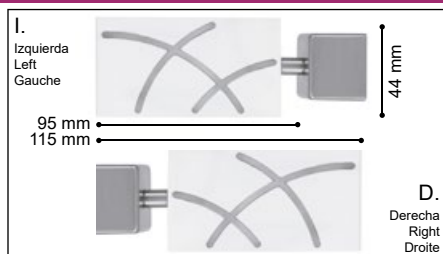

REF	∅	U	€	€	cm
P.21ABLD		10	21,62 €	24,86 €	
P.21ABLI		10	21,62 €	24,86 €	

* Terminal para Riel Manual Sintra® /
Finales for hand-drawn Sintra System® / Embouts pour Système Sintra® Manual

Ángulos blanco
Sintra Fial /
Embout Sintra

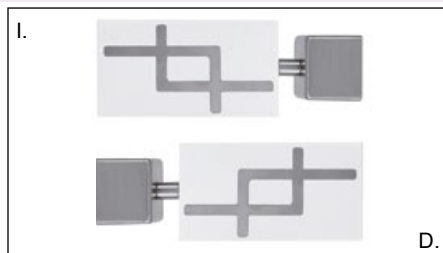

REF	∅	U	€	€	cm
P.22ABLD		10	21,62 €	24,86 €	
P.22ABLI		10	21,62 €	24,86 €	

* Terminal para Riel Manual Sintra® /
Finales for hand-drawn Sintra System® / Embouts pour Système Sintra® Manual

Ángulos negro
Sintra Fial /
Embout Sintra

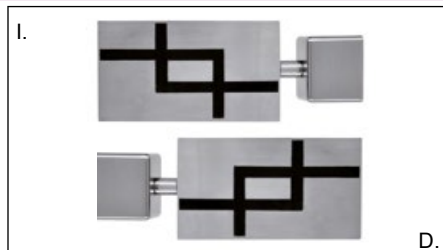

REF	∅	U	€	€	cm
P.23ABLD		10	21,86 €	25,14 €	
P.23ABLI		10	21,86 €	25,14 €	

* Terminal para Riel Manual Sintra® /
Finales for hand-drawn Sintra System® / Embouts pour Système Sintra® Manual

Olas
Sintra Fial /
Embout Sintra



REF	∅	U	€	€	cm
P.24ABLD		10	22,56 €	25,94 €	
P.24ABLI		10	22,56 €	25,94 €	

* Terminal para Riel Manual Sintra® /
Finales for hand-drawn Sintra System® / Embouts pour Système Sintra® Manual

Trazos
Sintra Fial /
Embout Sintra

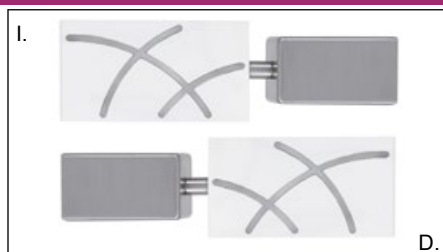

REF	∅	U	€	€	cm
P.25ABLD		10	22,72 €	26,13 €	
P.25ABLI		10	22,72 €	26,13 €	

* Terminal para Riel A Cordón Sintra® /
Finales for cord-drawn Sintra System® / Embouts pour système tirage Sintra® à cordon

Ángulos blanco
Sintra Fial /
Embout Sintra

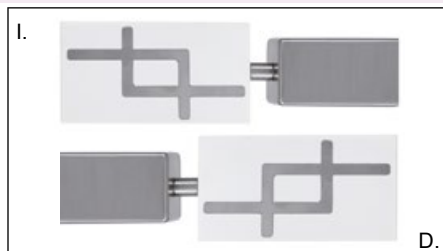

REF	∅	U	€	€	cm
P.26ABLD		10	22,72 €	26,13 €	
P.26ABLI		10	22,72 €	26,13 €	

* Terminal para Riel A Cordón Sintra® /
Finales for cord-drawn Sintra System® / Embouts pour système tirage Sintra® à cordon

Ángulos negro
Sintra Fial /
Embout Sintra

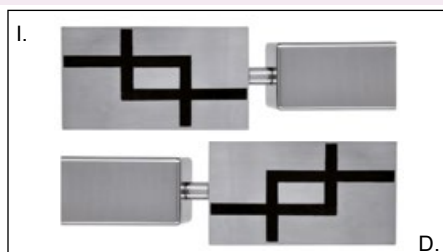

REF	∅	U	€	€	cm
P.27ABLD		10	22,72 €	26,13 €	
P.27ABLI		10	22,72 €	26,13 €	

* Terminal para Riel A Cordón Sintra® /
Finales for cord-drawn Sintra System® / Embouts pour système tirage Sintra® à cordon

Olas
Sintra Fial /
Embout Sintra



REF	∅	U	€	€	cm
P.28ABLD		10	23,60 €	27,14 €	
P.28ABLI		10	23,60 €	27,14 €	

* Terminal para Riel A Cordón Sintra® /
Finales for cord-drawn Sintra System® / Embouts pour système tirage Sintra® à cordon

Accesorios / Accessories / Accessoires



Perfil Sintra®
(Cordón y Manual)
Max. 6 kg./m.
Sintra® Track
(Corded & Manual
System) /
Rail Sintra®
(Tirage Cordon et
Manuel)

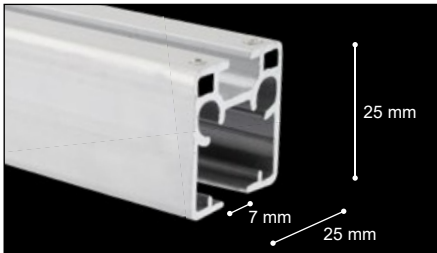

REF	-AP	-BC	-BL	-NB	U	€	€	cm
C.120342-	-AP	-BC	-BL	-NB	1		13,34 €	100
C.120342-	-AP	-BC	-BL	-NB	1		20,02 €	150
C.120342-	-AP	-BC	-BL	-NB	1		26,68 €	200
C.120342-	-AP	-BC	-BL	-NB	1		33,34 €	250
C.120342-	-AP	-BC	-BL	-NB	1		40,02 €	300
C.120342-	-AP	-BC	-BL	-NB	1		46,68 €	350
C.120342-	-AP	-BC	-BL	-NB	1		53,36 €	400
C.120342-	-AP	-BC	-BL	-NB	1		60,02 €	450
C.120342-	-AP	-BC	-BL	-NB	1		66,70 €	500
C.120342-	-AP	-BC	-BL	-NB	1		80,04 €	600

Perfiles Obidos®
(Cordón y Manual) /
Obidos® Track
(Corded & Manual
System) /
Rail Obidos®
(Tirage Cordon et
Manuel)

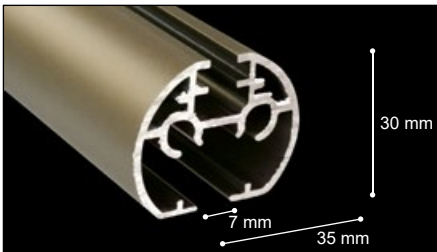

REF	-AP	-BC	-BL	-NB	U	€	€	cm
C.120442-	-AP	-BC	-BL	-NB	1		19,36 €	100
C.120442-	-AP	-BC	-BL	-NB	1		29,04 €	150
C.120442-	-AP	-BC	-BL	-NB	1		38,72 €	200
C.120442-	-AP	-BC	-BL	-NB	1		48,40 €	250
C.120442-	-AP	-BC	-BL	-NB	1		58,08 €	300
C.120442-	-AP	-BC	-BL	-NB	1		67,76 €	350
C.120442-	-AP	-BC	-BL	-NB	1		77,44 €	400
C.120442-	-AP	-BC	-BL	-NB	1		87,12 €	450
C.120442-	-AP	-BC	-BL	-NB	1		96,82 €	500
C.120442-	-AP	-BC	-BL	-NB	1		116,18 €	600

Perfiles Coimbra®
(Cordón y Manual)
Coimbra® Track
(Corded & Manual
System) /
Rail Coimbra®
(Tirage Cordon et
Manuel)

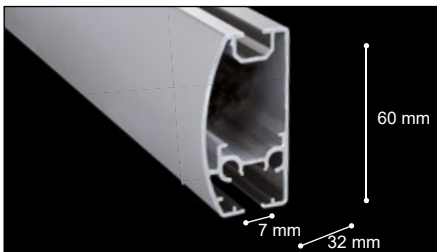

REF	-AP	-BC	-BL	-NB	U	€	€	cm
C.120542-	-AP	-BC	-BL	-NB	1		25,74 €	100
C.120542-	-AP	-BC	-BL	-NB	1		38,62 €	150
C.120542-	-AP	-BC	-BL	-NB	1		51,50 €	200
C.120542-	-AP	-BC	-BL	-NB	1		64,36 €	250
C.120542-	-AP	-BC	-BL	-NB	1		77,24 €	300
C.120542-	-AP	-BC	-BL	-NB	1		90,12 €	350
C.120542-	-AP	-BC	-BL	-NB	1		103,00 €	400
C.120542-	-AP	-BC	-BL	-NB	1		115,86 €	450
C.120542-	-AP	-BC	-BL	-NB	1		128,74 €	500
C.120542-	-AP	-BC	-BL	-NB	1		154,50 €	600

Terminal Tapón
Sintra®
(Sistema Cordón)

Sintra® endcap
(Corded System) /
Embout Sintra®
(Tirage Cordon)

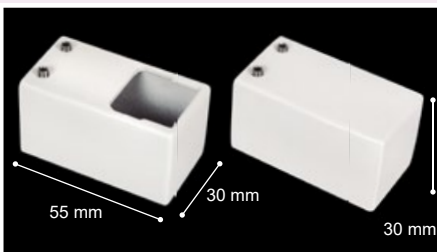

REF	∅	U	€	€	cm
P.55A		10	6,58 €	7,57 €	
P.55BC		10	6,58 €	7,57 €	
P.55BL		10	6,58 €	7,57 €	
P.55N		10	6,58 €	7,57 €	

Terminal Tapón
Sintra®
(Sistema Manual)

Sintra® endcap
(Manual System) /
Embout Sintra®
(Tirage Manuel)

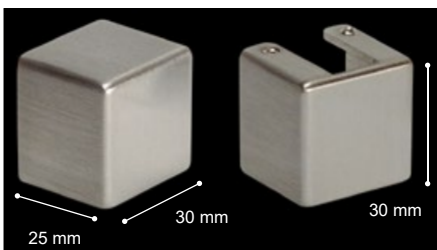

REF	∅	U	€	€	cm
P.54A		10	4,78 €	5,50 €	
P.54BC		10	4,78 €	5,50 €	
P.54BL		10	4,78 €	5,50 €	
P.54N		10	4,78 €	5,50 €	

* Terminal con 2 posiciones (A: La Corredera tiene tope / B: La Corredera llega hasta el final) /
2 position endcap (A: runner with end-screw / B: runner until the rail end). /
Embout avec 2 positions (A: glisseur avec vis arrêt / B: glisseur qui arrive en fin de rail).

Terminal Tapón Obidos (Sistema Manual) Obidos Final (Manual System) / Embout Obidos (Tirage Manuel)		REF	∅	U	€	€	cm
		P.56A		10	5,96 €	6,85 €	
		P.56BC		10	5,96 €	6,85 €	
		P.56BL		10	5,96 €	6,85 €	
		P.56NB		10	5,96 €	6,85 €	
Terminal Tapón Obidos (Sistema Cordón) Obidos final (Corded System) / Embout Obidos (Tirage Cordon)		REF	∅	U	€	€	cm
		P.58A		10	7,42 €	8,53 €	
		P.58BC		10	7,42 €	8,53 €	
		P.58BL		10	7,42 €	8,53 €	
		P.58NB		10	7,42 €	8,53 €	
Terminal Tapón Coimbra (lado D e I) (Sistema Manual) Coimbra Final (side D & I) (Manual System) / Embout Coimbra (côté D et I) (Tirage Manuel)		REF	∅	U	€	€	cm
		P.57AD / P.57AI		10	7,44 €	8,56 €	
		P.57BCD / P.57BCI		10	7,44 €	8,56 €	
		P.57BLD / P.57BLI		10	7,44 €	8,56 €	
		P.57NBD / P.57NBI		10	7,44 €	8,56 €	
Terminal Tapón Coimbra (Sistema Cordón) Coimbra Final (side D & I) (Corded System) / Embout Coimbra (côté D et I) (Tirage Cordon)		REF	∅	U	€	€	cm
		P.59AD / P.59AI		10	8,78 €	10,10 €	
		P.59BCD / P.59BCI		10	8,78 €	10,10 €	
		P.59BLD / P.59BLI		10	8,78 €	10,10 €	
		P.59NBD / P.59NBI		10	8,78 €	10,10 €	
Soporte Pared Wall Brackets / Supports Mur		REF	∅	U	€	€	cm
		N.113A		10	11,96 €	13,75 €	
		N.113BC		10	11,96 €	13,75 €	
		N.113BL		10	11,96 €	13,75 €	
		N.113N		10	11,96 €	13,75 €	
* Soporte incluido en el Kit Sencillo Manual / Bracket supplied in the Manual Single Kit / Support fourni dans le Manuel Simple Kit.							
Soporte Doble Pared Double Wall Bracket / Support Mur Double		REF	∅	U	€	€	cm
		O.113A		10	14,86 €	17,09 €	
		O.113BC		10	14,86 €	17,09 €	
		O.113BL		10	14,86 €	17,09 €	
		O.113N		10	14,86 €	17,09 €	
* Soporte incluido en el Kit Doble Manual / Bracket supplied in the Manual Double kit / Support fourni dans le Manuel Kit Double.							
Soporte Pared Largo Long Wall Bracket / Support Mur Long		REF	∅	U	€	€	cm
		N.115A		10	14,86 €	17,09 €	
		N.115BC		10	14,86 €	17,09 €	
		N.115BL		10	14,86 €	17,09 €	
		N.115N		10	14,86 €	17,09 €	
Soporte Techo Ceiling Bracket / Support Plafond		REF	∅	U	€	€	cm
		N.114A		10	11,98 €	13,78 €	
		N.114BC		10	11,98 €	13,78 €	
		N.114BL		10	11,98 €	13,78 €	
		N.114N		10	11,98 €	13,78 €	

Accesorios / Accessories / Accessoires



Soporte Techo Plástico

Plastic Ceiling Bracket / Support Plafond Plastique

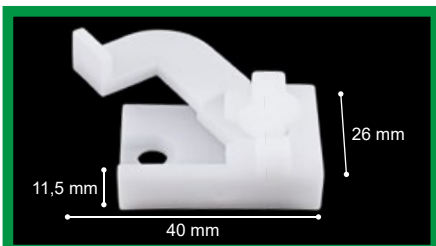

REF	∅	U	€	€ ¹	cm
N.131A		100	0,84 €	0,97 €	

* Soporte incluido en el Kit Sencillo y Doble a Cordón. / Bracket supplied in the Single & Double Kit with Cord / Support fourni dans le Simple et Double Kit avec Cord.

Soporte Invisible Plano Techo

Invisible Ceiling Bracket / Support Invisible Plafond Plat

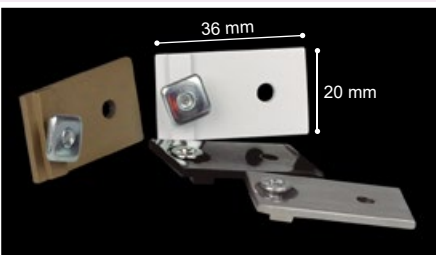

REF	∅	U	€	€ ¹	cm
N.134A		25	2,80 €	3,22 €	
N.134BC		25	2,80 €	3,22 €	
N.134BL		25	2,80 €	3,22 €	
N.134NB		25	2,80 €	3,22 €	

* Soporte incluido en el Kit Sintra® A Techo / Bracket supplied in the Sintra® Ceiling Kit / Support fourni dans le Sintra® Kit Plafond

NEW

Cantонера de Plástico

Plastic end Pulley / Angles Plástico



REF	∅	U	€	€ ¹	cm
W.63		25	3,06 €	3,52 €	

Corredera Maestra Sintra® Cinta Acordeón Derecha

Sintra® maste carrier ruffle tape (right) / Porteur principal Sintra® ruban accordéon (droite)



REF	∅	U	€	€ ¹	cm
W.1026		25	6,04 €	6,95 €	

Corredera Maestra Sintra® Cinta Acordeón Izquierda

Sintra® master carrier ruffle tape(left) / Porteur principal Sintra® ruban accordéon (gauche)



REF	∅	U	€	€ ¹	cm
W.1027		25	6,04 €	6,95 €	

Corredera Maestra con Brazo Sintra®

Sintra® master carrier with arm / Porteur principal Sintra® avec bras

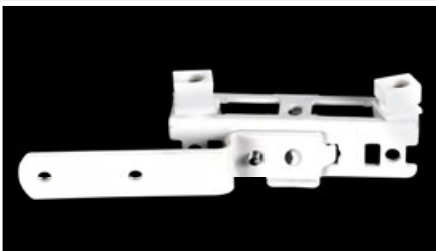

REF	∅	U	€	€ ¹	cm
W.1028		25	3,90 €	4,49 €	

Corredera Maestra sin Brazo Sintra®

Sintra® master carrier without arm / Porteur principal Sintra® sans bras

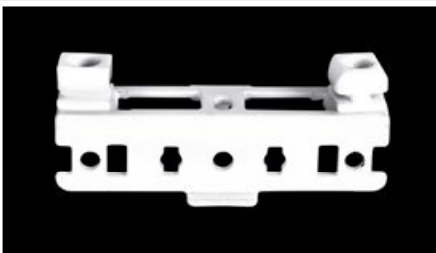

REF	∅	U	€	€ ¹	cm
W.1029		25	2,78 €	3,20 €	

Juego de Correderas Maestras para Riel Sintra®

Set of master gliders for Sintra® Track / Kit glisseur principal rail Sintra®



REF	∅	U	€	€ ¹	cm
D.785		25	7,42 €	8,53 €	

Corredera Aérea Lateral O. Perfecta 55

Wave lateral overlap master carrier 55 / Glisseur croisement lateral wave 55

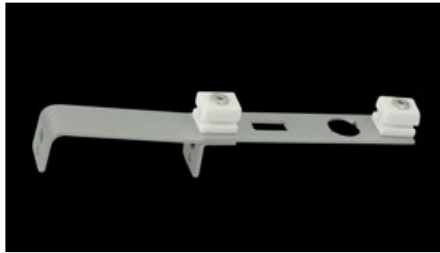

REF	∅	U	€	1	cm
D.786A		25	3,84 €	4,42 €	
D.786BC		25	3,84 €	4,42 €	
D.786BL		25	3,84 €	4,42 €	
D.786NB		25	3,84 €	4,42 €	

NEW

Corredera Aérea Lateral Cinta Acordeón paso 55 mm

Ruffle tape lateral overlap master carrier 55 mm snap-buttons / Glisseur croisement lateral ruban wave 55mm pour bouton automat

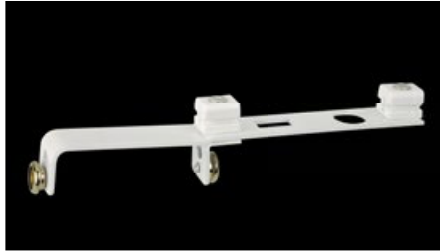

REF	∅	U	€	1	cm
D.787A		25	4,60 €	5,29 €	
D.787BC		25	4,60 €	5,29 €	
D.787BL		25	4,60 €	5,29 €	
D.787NB		25	4,60 €	5,29 €	

NEW

Corredera Aérea Lateral O. Perfecta 80

Wave lateral overlap master carrier 80 / Glisseur croisement lateral wave 80

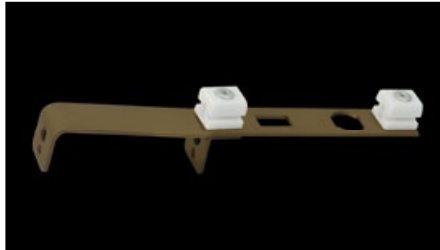

REF	∅	U	€	1	cm
D.788A		25	4,82 €	5,54 €	
D.788BC		25	4,82 €	5,54 €	
D.788BL		25	4,82 €	5,54 €	
D.788NB		25	4,82 €	5,54 €	

NEW

Empalme Sintra® y Obidos (Manual y Cordón)
Sintra® & Obidos splice (corded & manual system) / Raccordeur Sintra® et Obidos (tirage avec corde et manuel)

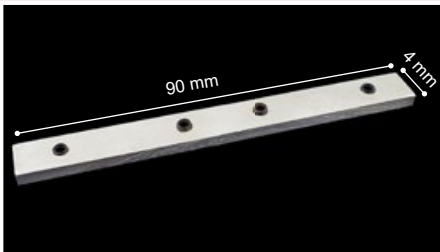

REF	∅	U	€	1	cm
H.05PL		10	7,06 €	8,12 €	

Empalme Coimbra® (Manual y Cordón)

Coimbra® splice (corded & manual system) / Raccordeur Coimbra® (tirage avec corde et manuel)

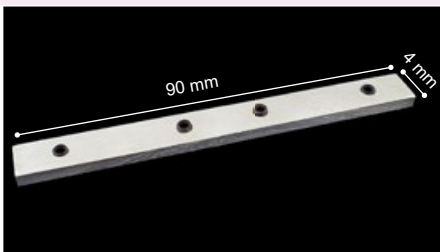

REF	∅	U	€	1	cm
H.06PL		10	7,06 €	8,12 €	

Rollo Cinta Acordeón con Automáticos

Ruffle-tape roll with snap-buttons / Rouleau ruban accordéon avec système bouton automat

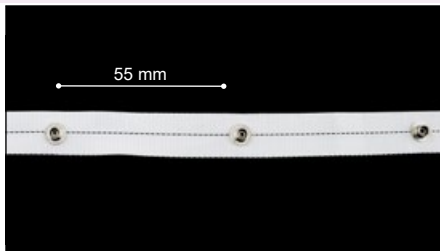

REF	∅	U	€	1	m
D.111		1	203,28 €	233,77 €	

* 1 rollo contiene 840 corchetes / Roll of 840 Snaps / Rouleau de 840 crochets.

Rollo Corredera Acordeón

Corded gliders roll / Rouleau glisseurs acordeón

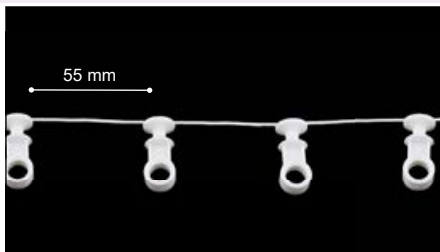

REF	∅	U	€	1	cm
D.112		1	151,20 €	173,88 €	

* 1 rollo contiene 1000 correderas / Roll of 1000 runners / Rouleau de 1000 glisseurs.

Rollo Corredera Onda Perfecta

Perfect wave runners roll / Rouleau de glisseur "onde parfaite"

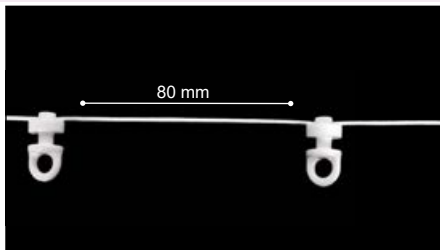

REF	∅	U	€	1	cm
D.113		1	151,20 €	173,88 €	

* 1 rollo contiene 1000 correderas / Roll of 1000 runners / Rouleau de 1000 glisseurs.

Accesorios / Accessories / Accessoires



Rollo Corredera
Onda Perfecta

Perfect wave
runners roll /
Rouleau de glisseur
"onde parfaite"

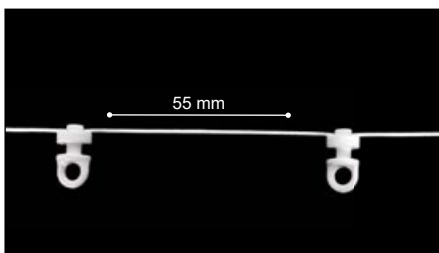

REF	∅	U	€	1 €	cm
D.114		1	151,20 €	173,88 €	

* 1 rollo contiene 1000 correderas / Roll of 1000 runners / Rouleau de 1000 glisseurs.

Cinta
Armadora con bolsas

Buckram With
pouches /
Ruban de monter
avec pouches



REF	COLOR	rollo (m) roll (m)	€	RAPPORT	mm
D.217	blanco/white	200 m	0,84 €/m		70 mm
D.217BG	beige	200 m	0,84 €/m		70 mm
D.218	blanco/white	200 m	0,98 €/m		90 mm
D.218BG	beige	200 m	0,98 €/m		90 mm
D.235TR	transparente	100 m	1,24 €/m		120 mm

Cinta Armadora
Onda Perfecta
75 mm. 2 Bolsas

Perfect wave buckram
75mm 2 pockets /
Buckram onde parfaite
75mm 2 pouches

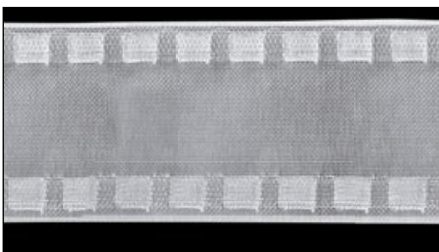

REF	COLOR	rollo (m) roll (m)	€	RAPPORT	mm
D.230TR	transparente	100 m	1,20 €/m	1:2,5 (+40 cm)	75 mm

Rollo Cordón 3,5mm.

Roll Cord /
Rouleau Corde



REF	∅	U	€	1 €	cm
D.036GR		1		55,14 €	
D.036		1		68,38 €	
D.036BC		1		71,34 €	

Caja de 1000
ganchos

Hooks Box for tape
1000 u /
Boîte de 1000
crochets
pour ruban



REF	∅	U	€	1 €	cm
D.400		1000	15,70 €		
D.401		1000	16,38 €		

Corredera con Ruedas

Wheeled Runner /
Glisseur Plastique



REF	∅	U	€	1 €	cm
D.783		1000	0,268 €/ud.	0,322 €	

Contrapeso Cordón

Cordweight /
Contrepoids cordon



REF	∅	U	€	1 €	cm
I.1150		25	1,52 €	1,82 €	
I.1150BC		25	1,70 €	2,04 €	
I.1150GR		25	1,70 €	2,04 €	
I.1150N		25	1,70 €	2,04 €	

Blocacuerda de Plástico

Cord-Lock / Frein-Corde Plastique



REF	∅	U	€	€	cm
W.64		100	0,68 €	0,78 €	

Tope

End-stop / Vis d'arrêt



REF	∅	U	€	€	cm
D.784		10	0,226 €	0,271 €	

Muestra Riel Sintra®

Demo Sample Sintra® track / Échantillon Rail Sintra®

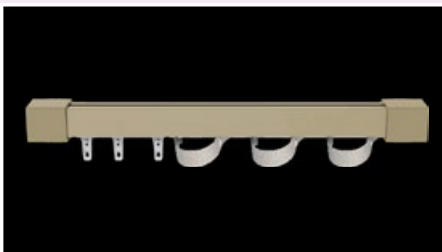

REF	∅	U	€	€	cm
M.1		1		24,82 €	

Muestra Riel Obidos®

Demo Sample Obidos® track / Échantillon Rail Obidos

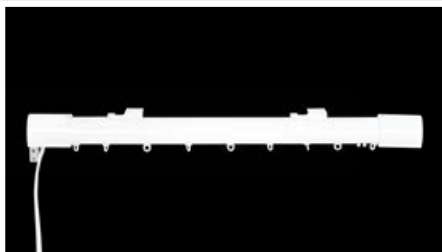

REF	∅	U	€	€	cm
M.253		1		28,02 €	

Muestra Riel Coimbra®

Demo Sample Coimbra® track / Échantillon Rail Coimbra®



REF	∅	U	€	€	cm
M.254		1	-	30,36 €	

ALTRAN®
SISTEMAS PARA DECORAR CORTINAS

Barras
Rieles
Motorizados
Técnico
Decorativo
Estores
Paneles
Cintas
Accesorios

3,5cm
8,5cm

23g
CONTRAPESO DECORATIVO

En la sección de Accesorios puedes encontrar más opciones.
Pág. 334.

In the "accessories" section you will find further options.
Pág. 334.

Vous trouverez plusieurs options dans la section "accessoires".
Pág. 334.

■ **Opción:
Correderas**
Option Gliders
Option Glisseurs



Wengué
Wenge



Plata Mate
Satin silver / Nickel satiné

■ **Opción:
Cinta Acordeón**
Option Ruffle-tape Roll
Option Rouleau Ruban
Accordéon



Cerezo
Cherry /
Merisier

■ **Opción:
Onda Perfecta**
Option Perfect Wave
Option Onde Parfaite



Blanco
White / Blanc



Negro
Black / Noir

■ Riel cilíndrico que simula una elegante Barra Decorativa, diferenciándose así del resto de rieles del mercado. La colección Córcega es el resultado de la unión de dos conceptos: por fuera es una auténtica barra decorativa, mientras que por dentro, es uno de los mejores rieles del mercado, capaz de albergar Correderas Normales y/o Correderas de "Onda Perfecta" (nuestro particular y económico sistema para garantizar una caída y una onda perfecta en toda cortina). El gran diseño y estilo del Riel Córcega, incluyendo sus resistentes Soportes, transmite elegancia y sencillez, convirtiéndolo en el Riel Ideal para decorar cualquier estancia donde la estética y el diseño sean lo principal.

■ Cylindrical rail made of DM simulating an elegant decorative pole. This characteristic differs from the rest of the decorative rails of the market. The Córcega collection is the result of the union of two concepts: outside is a real decorative bar and inside is one of the best rails on the market, where can be used normal gliders but also ripple fold wave gliders to make the "perfect wave" (our economic system that ensures a perfect fall and a perfect wave on every curtain). The design and style of the rail Córcega, including its strong supports, provides elegance and simplicity, making this rail ideal for the decoration of any room where aesthetics and design are the most important.

■ Rail cylindrique en DM simulant un tringle décorative et élégante. Cette caractéristique distingue ce rail du reste de rails décoratifs du marché. La collection Córcega est le résultat de l'union de deux concepts: l'extérieur est un tringle décorative et à l'intérieur a un des meilleurs rails sur le marché où peuvent être utilisés les glisseurs normales mais également les glisseurs pour ruban accordéon pour faire "l'onde parfaite" (notre système économique qui assure un tombé parfaite et une onde parfaite à chaque rideau). Le design et le style du rail Córcega, compris ses solides supports, offre élégance et simplicité, ce qui fait le rail idéal pour la décoration de toute chambre où l'esthétique et le design sont les plus importants.

Conjuntos completos con corredera standard D.07 /
 Complete sets with standard runner D.07 /
 Kits complets avec glisseur standard D.07



Incremento para Sistema Onda Perfecta / Price increase perfect wave system / Hausse prix système onde parfaite:
 D.111: 4,80 €/m D.112: 3,30 €/m D.113: 3,30 €/m D.114: 3,30 €/m

Córcega Color Wengué / Wenge / Wenge



REF					
K.724432	2	26	1	129,47 €	244
K.736632	3	38	1	182,07 €	366

Córcega Color Plata Mate / Satin Silver / Nickel Satiné



REF					
K.7244PM	2	26	1	129,47 €	244
K.7366PM	3	38	1	182,07 €	366

Córcega Color Cerezo / Cherry / Merisier



REF					
K.72449	2	26	1	129,47 €	244
K.73669	3	38	1	182,07 €	366

Córcega Color Blanco / White / Blanc



REF					
K.724422	2	26	1	129,47 €	244
K.736622	3	38	1	182,07 €	366

Córcega Color Negro / Black / Noir



REF					
K.724423	2	26	1	129,47 €	244
K.736623	3	38	1	182,07 €	366

Contenido del Kit / Kit components / Composants du Kit

 Conjuntos Sencillos (244 cm): 2 terminales, 2 soportes, perfil, tornillo tope y correderas.
 Conjuntos Sencillos (366 cm): 2 terminales, 3 soportes, tornillo tope, perfil y correderas.

 Single sets (244 cm): 2 finials, 2 brackets, track, end-stop & runners.
 Single sets (366 cm): 2 finials, 3 brackets, track, end-stop & runners.

 Kits simples (244cm): 2 embouts, 2 supports, rail, vis d'arrêt et glisseurs.
 Kits simples (366 cm): 2 embouts, 3 supports, rail, vis d'arrêt et glisseurs.

Posibilidades de montaje / Installation possibilities / Possibilités de montage



 El Riel Córcega permite combinar gracias a su soporte doble, un magnífico riel decorativo junto a un práctico riel técnico. En este ejemplo podemos ver la combinación de Riel Argent y Riel Córcega. Cualquier estancia se verá enriquecida con la elegante decoración del Riel Córcega, mientras que el Riel Argent aumenta sus posibilidades a la hora de buscar soluciones decorativas.

 The Córcega track offers the possibility of merging thanks to its special double bracket, one unique example of decorative splendor provided by the Córcega track together with the technical and practical nature of the Argent track. Any space will be enriched with the decorative elegance of the Córcega rail whereas the Argent rail will increase the possibilities regarding new decorative solutions.







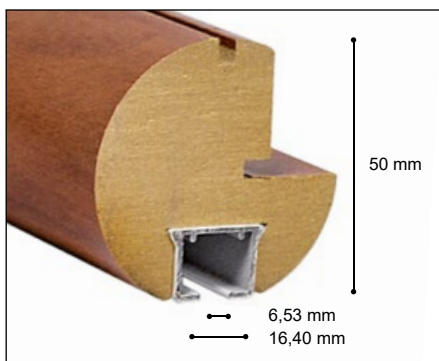

 Le rail Córcega vous permet de fusionner grâce à son support double, un exemple unique de la splendeur décorative avec un rail technique et pratique. Dans cet exemple on peut vérifier la fusion du riel Argent et Córcega. N'importe quel espace sera enrichi avec l'élégance décorative du rail Córcega, tandis que le rail Argent augmente les chances d'obtenir nouvelles solutions décoratives.

Accesorios / Accessories / Accessoires



Perfil Córcega
Córcega Profile /
Córcega Rail



REF	 -32	 -9	 -PM	 -22	 -23				
G.2244-	-32	-9	-PM	-22	-23	5	61,28 €	70,47 €	244
G.2366-	-32	-9	-PM	-22	-23	5	90,00 €	103,50€	366

Tapón Acero
Steel Finial /
Bouchon Acier



REF	∅	U	€	€	cm
D.012A		10	8,24 €	9,48 €	

Soporte Frontal
Wall Bracket /
Support Mur

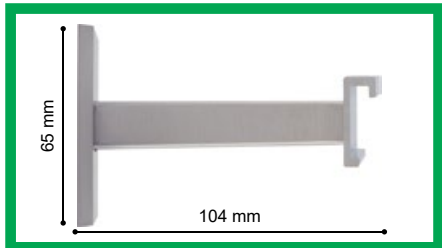

REF	∅	U	€	€	cm
N.9AS		10	16,22 €	18,65 €	

* Soporte incluido en el Kit Sencillo /
Bracket supplied in the Single Kit / Support fourni dans le Simple Kit.

Soporte Frontal
Wall Bracket /
Support Mur

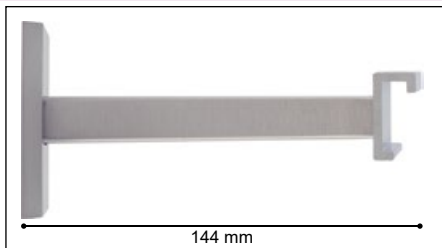

REF	∅	U	€	€	cm
N.117AS		10	18,94 €	21,78 €	

Soporte Techo
Ceiling Bracket /
Support plafond

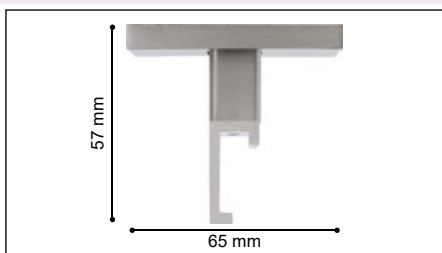

REF	∅	U	€	€	cm
N.116AS		10	17,00 €	19,55 €	

Soporte Doble
Double Wall
Bracket /
Support
Mur Double

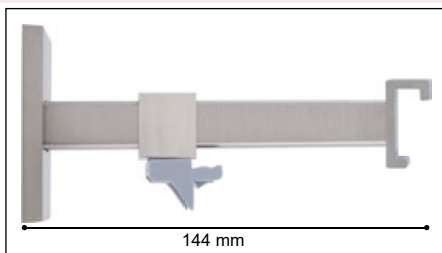

REF	∅	U	€	€	cm
O.115AS		10	23,12 €	26,59 €	

Tornillo tope
End-Stop Screw /
Vis d'arrêt



REF	∅	U	€	€	cm
D.08		1000	0,31 €	0,37 €/ud	

Corredera Maestra
Plastic Master
Runner /
Coulisse Plastic
Principal



REF	∅	U	€	€	cm
D.42		25	3,22 €	3,70 €	

Corredera
Runner /
lisseur

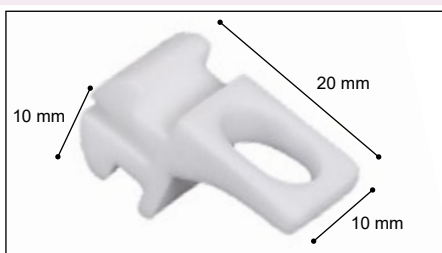

REF	∅	U	€	€	cm
D.07		500	0,064 €	0,077 €	

Accesorios / Accessories / Accessoires



<p>Rollo Cinta Acordeón con Automáticos</p> <p>Ruffle-tape roll with snap-buttons / Rouleau ruban accordéon avec système automat</p>		<table border="1"> <thead> <tr> <th>REF</th> <th>∅</th> <th>U</th> <th>€</th> <th>€</th> <th>cm</th> </tr> </thead> <tbody> <tr> <td>D.111</td> <td></td> <td>1</td> <td>203,28 €</td> <td>233,77 €</td> <td></td> </tr> </tbody> </table> <p>* 1 rollo contiene 840 corchetes / Roll of 840 Snaps / Rouleau de 840 crochets.</p>	REF	∅	U	€	€	cm	D.111		1	203,28 €	233,77 €	
REF	∅	U	€	€	cm									
D.111		1	203,28 €	233,77 €										
<p>Rollo Corredera Acordeón</p> <p>Corded gliders roll / Rouleau glisseurs acordeón</p>		<table border="1"> <thead> <tr> <th>REF</th> <th>∅</th> <th>U</th> <th>€</th> <th>€</th> <th>cm</th> </tr> </thead> <tbody> <tr> <td>D.112</td> <td></td> <td>1</td> <td>151,20 €</td> <td>173,88 €</td> <td></td> </tr> </tbody> </table> <p>* 1 rollo contiene 1000 correderas / Roll of 1000 runners / Rouleau de 1000 glisseurs.</p>	REF	∅	U	€	€	cm	D.112		1	151,20 €	173,88 €	
REF	∅	U	€	€	cm									
D.112		1	151,20 €	173,88 €										
<p>Rollo Corredera Onda Perfecta</p> <p>Perfect wave runners roll / Rouleau de glisseur "onde parfaite"</p>		<table border="1"> <thead> <tr> <th>REF</th> <th>∅</th> <th>U</th> <th>€</th> <th>€</th> <th>cm</th> </tr> </thead> <tbody> <tr> <td>D.113</td> <td></td> <td>1</td> <td>151,20 €</td> <td>173,88 €</td> <td></td> </tr> </tbody> </table> <p>* 1 rollo contiene 1000 correderas / Roll of 1000 runners / Rouleau de 1000 glisseurs.</p>	REF	∅	U	€	€	cm	D.113		1	151,20 €	173,88 €	
REF	∅	U	€	€	cm									
D.113		1	151,20 €	173,88 €										
<p>Rollo Corredera Onda Perfecta</p> <p>Perfect wave runners roll / Rouleau de glisseur "onde parfaite"</p>		<table border="1"> <thead> <tr> <th>REF</th> <th>∅</th> <th>U</th> <th>€</th> <th>€</th> <th>cm</th> </tr> </thead> <tbody> <tr> <td>D.114</td> <td></td> <td>1</td> <td>151,20 €</td> <td>173,88 €</td> <td></td> </tr> </tbody> </table> <p>* 1 rollo contiene 1000 correderas / Roll of 1000 runners / Rouleau de 1000 glisseurs.</p>	REF	∅	U	€	€	cm	D.114		1	151,20 €	173,88 €	
REF	∅	U	€	€	cm									
D.114		1	151,20 €	173,88 €										
<p>Embellecedor para empalme Córcega</p> <p>Decorative joiner Córcega / Raccordeur decoratif Córcega</p>		<table border="1"> <thead> <tr> <th>REF</th> <th>∅</th> <th>U</th> <th>€</th> <th>€</th> <th>cm</th> </tr> </thead> <tbody> <tr> <td>H.09A</td> <td></td> <td>10</td> <td>9,88 €</td> <td>11,36 €</td> <td></td> </tr> </tbody> </table> <p>NEW</p>	REF	∅	U	€	€	cm	H.09A		10	9,88 €	11,36 €	
REF	∅	U	€	€	cm									
H.09A		10	9,88 €	11,36 €										
<p>Alargador Soporte</p> <p>Bracket extender / Extendeur pour bracket</p>		<table border="1"> <thead> <tr> <th>REF</th> <th>∅</th> <th>U</th> <th>€</th> <th>€</th> <th>cm</th> </tr> </thead> <tbody> <tr> <td>R.2001AS</td> <td></td> <td>10</td> <td>6,18 €</td> <td>7,11 €</td> <td></td> </tr> </tbody> </table>	REF	∅	U	€	€	cm	R.2001AS		10	6,18 €	7,11 €	
REF	∅	U	€	€	cm									
R.2001AS		10	6,18 €	7,11 €										
<p>Adaptador rieles madera</p> <p>Wood track adaptador / Adapteur pour rails en bois</p>		<table border="1"> <thead> <tr> <th>REF</th> <th>∅</th> <th>U</th> <th>€</th> <th>€</th> <th>cm</th> </tr> </thead> <tbody> <tr> <td>H.28</td> <td></td> <td>10</td> <td>2,78 €</td> <td>3,20 €</td> <td></td> </tr> </tbody> </table>	REF	∅	U	€	€	cm	H.28		10	2,78 €	3,20 €	
REF	∅	U	€	€	cm									
H.28		10	2,78 €	3,20 €										
<p>Muestra Riel Córcega</p> <p>Demo Sample Córcega track / Échantillon Rail Córcega</p>		<table border="1"> <thead> <tr> <th>REF</th> <th>∅</th> <th>U</th> <th>€</th> <th>€</th> <th>cm</th> </tr> </thead> <tbody> <tr> <td>M.251</td> <td></td> <td>1</td> <td></td> <td>22,06 €</td> <td></td> </tr> </tbody> </table>	REF	∅	U	€	€	cm	M.251		1		22,06 €	
REF	∅	U	€	€	cm									
M.251		1		22,06 €										



Somos especialistas en decoración
y disponemos de múltiples soluciones para cualquier proyecto.
Descubre nuestros rieles decorativos de diseño y de calidad.

RIELES DECORATIVOS
DISEÑO PERSONAL
LA FORMA DE TENER UN HOGAR DIFERENTE

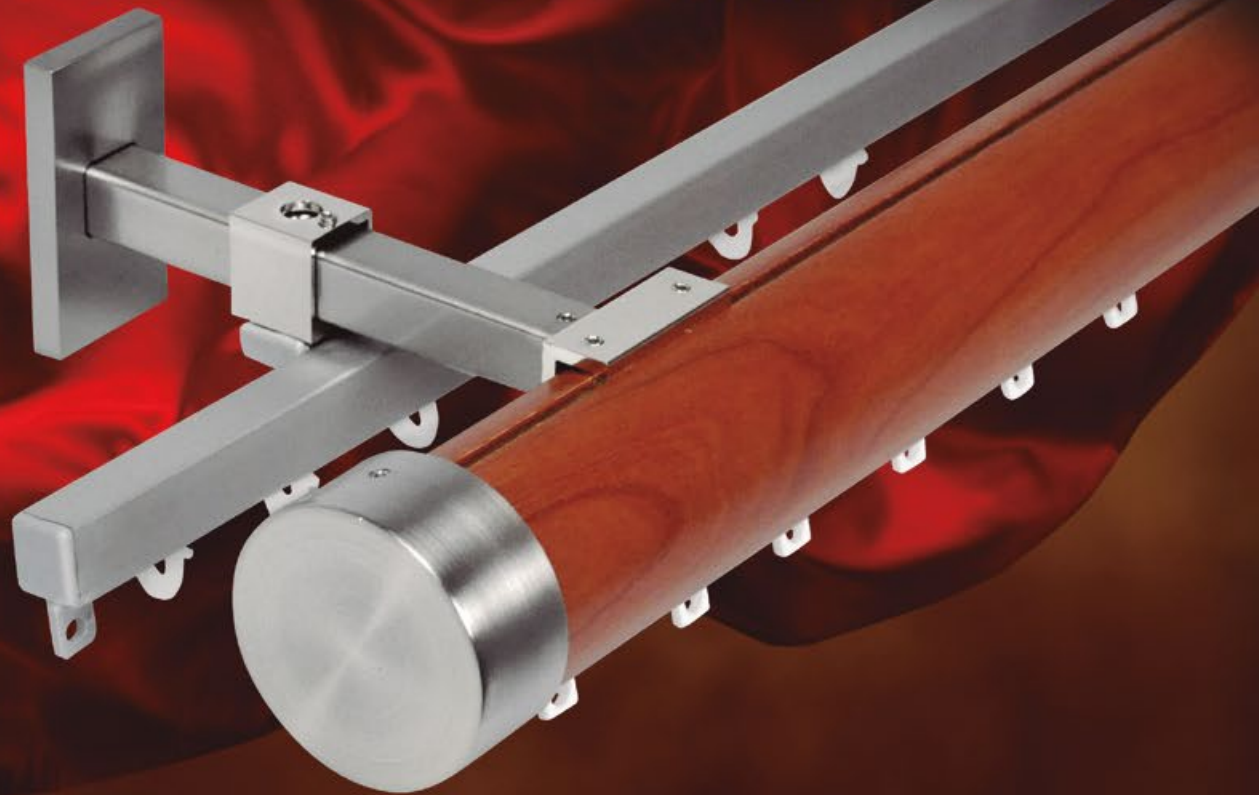

Riel Decorativo Plano / Plain Decorative Rail / Rail Décoratif Plan

■ **Opción:
Correderas**
Option Gliders
Option Glisseurs



Wengué
Wenge



Plata Mate
Satin silver / Nickel satiné

■ **Opción:
Cinta Acordeón**
Option Ruffle-tape Roll
Option Rouleau Ruban
Accordéon



Cerezo
Cherry /
Merisier

■ **Opción:
Onda Perfecta**
Option Perfect Wave
Option Onde Parfaite



Blanco
White / Blanc



Negro
Black / Noir

■ Riel rectangular que transmite modernidad y esmero por la decoración.

La colección Capri nos permite disfrutar de las ventajas de un riel de gran calidad y de la estética decorativa de una Barra de auténtico diseño, por ello su presencia en cualquier sala, lo hará destacar del resto de rieles existentes. Su adaptabilidad nos permitirá emplear cualquier tipo de corredera, desde las más básicas hasta la de onda perfecta (económico sistema para confeccionar cortinas con la onda perfecta) pasando por las cintas armadoras o las correderas de acordeón. Su uso en cualquier proyecto, garantiza la versatilidad y el éxito decorativo.

■ Rectangular rail made of DM that transmits modernity and elegance in decoration.

The Capri collection allows to enjoy the benefits of a high quality rail together with the decoration of a design pole, so its presence in any room, differentiates from other existing rails. Its adaptability allow us to use any type of glider, from the most basic to the perfect wave (our economic system that ensures a perfect fall and a perfect wave on every curtain. Also can be used with all our range of buckram tapes). Every project where it will be used, its guaranteed with its versatility and decorative success.

■ Rail rectangulaire en DM qui transmet la modernité et l'élégance dans la décoration.

La collection Capri permet de profiter des avantages d'un rail de haute qualité avec la décoration d'une tringle, de sorte que sa présence dans toutes les chambres le différencie des autres rails existants. Son adaptabilité permet d'utiliser les glisseurs normales mais également les glisseurs pour ruban accordéon pour faire "l'onde parfaite" (notre système économique qui assure un tombé parfaite et une onde parfaite à chaque rideau). Est le rail idéal pour la décoration de toute chambre où l'esthétique et le design sont les plus importants.

Conjuntos completos con corredera standard **D.07** /
 Complete sets with standard runner **D.07** /
 Kits complets avec glisseur standard **D.07**



Incremento para Sistema Onda Perfecta / Price increase perfect wave system / Hausse prix système onde parfaite:
D.111: 4,80 €/m **D.112:** 3,30 €/m **D.113:** 3,30 €/m **D.114:** 3,30 €/m

Capri Color Wengué / Wenge / Wenge



REF					
K.824432	2	26	1	100,79 €	244
K.836632	3	38	1	141,62 €	366

Capri Color Plata Mate / Satin Silver / Nickel Satiné



REF					
K.8244PM	2	26	1	107,21 €	244
K.8366PM	3	38	1	151,23 €	366

Capri Color Cerezo / Cherry / Merisier



REF					
K.82449	2	26	1	100,79 €	244
K.83669	3	38	1	141,62 €	366

Capri Color Blanco / White / Blanc



REF					
K.824422	2	26	1	107,21 €	244
K.836622	3	38	1	151,23 €	366

Capri Color Negro / Black / Noir



REF					
K.824423	2	26	1	107,21 €	244
K.836623	3	38	1	151,23 €	366

Contenido del Kit / Kit components / Composants du Kit

🇪🇸 Conjuntos Sencillos (244 cm): 2 terminales, 2 soportes, perfil, tornillo tope y correderas.
 Conjuntos Sencillos (366 cm): 2 terminales, 3 soportes, tornillo tope, perfil y correderas.

🇬🇧 Single sets (244 cm): 2 finials, 2 brackets, track, end-stop & runners.
 Single sets (366 cm): 2 finials, 3 brackets, track, end-stop & runners.

🇫🇷 Kits simples (244cm): 2 embouts, 2 supports, rail, vis d'arrêt et glisseurs.
 Kits simples (366 cm): 2 embouts, 3 supports, rail, vis d'arrêt et glisseurs.

Posibilidades de montaje / Installation possibilities / Possibilités de montage



🇪🇸 El Riel Capri permite combinar gracias a su perfil doble, un magnífico riel decorativo junto a un práctico riel técnico. En este ejemplo podemos ver la combinación de Riel Argent y Riel Capri. Cualquier estancia se verá enriquecida con la elegante decoración del Riel Capri, mientras que el Riel Argent aumenta sus posibilidades a la hora de buscar soluciones decorativas.

🇬🇧 The Capri track offers the possibility of merging thanks to its special double profile, one unique example of decorative splendor provided by the Capri track together with the technical and practical nature of the Argent track. Any space will be enriched with the decorative elegance of the Capri rail whereas the Argent rail will increase the possibilities regarding new decorative solutions.

🇫🇷 Le rail Capri vous permet de fusionner grâce à son profil double, un exemple unique de la splendeur décorative avec un rail technique et pratique. Dans cet exemple on peut vérifier la fusion du riel Argent et Capri. N'importe quel espace sera enrichi avec l'élégance décorative du rail Capri, tandis que le rail Argent augmente les chances d'obtenir nouvelles solutions décoratives.

Accesorios / Accessories / Accessoires

32 9 PM 22 23

Perfil Capri
Capri Profile /
Capri Rail

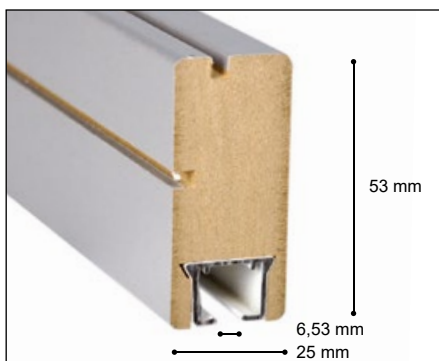

REF	32	9	PM	22	23	U	€	1	cm
G.3244-	-32	-9				5	37,38 €	42,99 €	244
G.3244-			-PM	-22	-23	5	42,96 €	49,40 €	244
G.3366-	-32	-9				5	55,86 €	64,24 €	366
G.3366-			-PM	-22	-23	5	64,22 €	73,85 €	366

Tapón Acero
Steel Finial /
Bouchon Acier

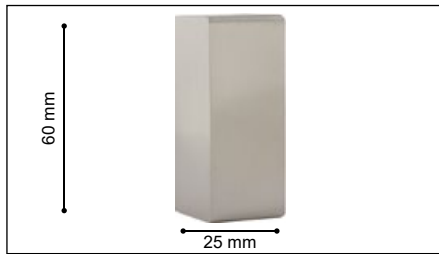

REF	∅	U	€	€	cm
D.011A		10	7,72 €	8,88 €	

Soporte Frontal
Wall Bracket /
Support Mur

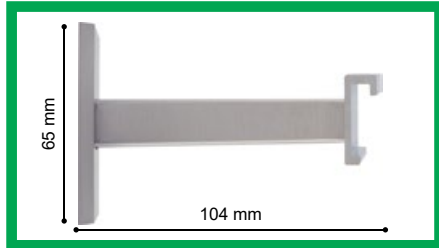

REF	∅	U	€	€	cm
N.9AS		10	16,22 €	18,65 €	

* Soporte incluido en el Kit Sencillo
/ Bracket supplied in the Single Kit / Support fourni dans le Simple Kit.

Soporte Frontal
Wall Bracket /
Support Mur

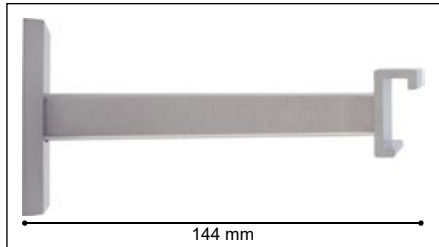

REF	∅	U	€	€	cm
N.117AS		10	18,94 €	21,78 €	

Soporte Techo
Ceiling Bracket /
Support plafond

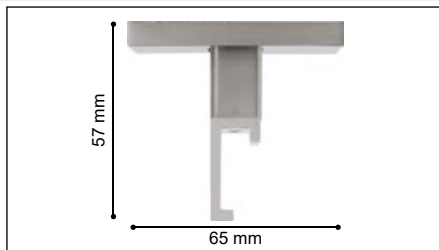

REF	∅	U	€	€	cm
N.116AS		10	17,00 €	19,55 €	

Soporte Doble
Double Wall
Bracket /
Support
Mur Double

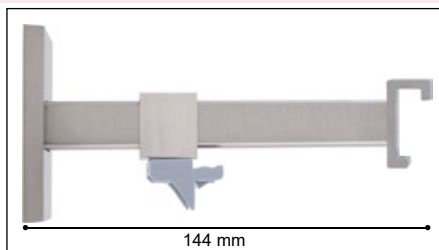

REF	∅	U	€	€	cm
O.115AS		10	23,12 €	26,59 €	

Tornillo tope
End-Stop /
Vis d'arrêt final



REF	∅	U	€	€	cm
D.08		1000	0,31 €	0,37 €/ud	

Corredera Maestra
Plastic Master
Runner /
Coulisse Plastic
Principal



REF	∅	U	€	€	cm
D.42		25	3,22 €	3,70 €	

Corredera
Runner /
lisseur

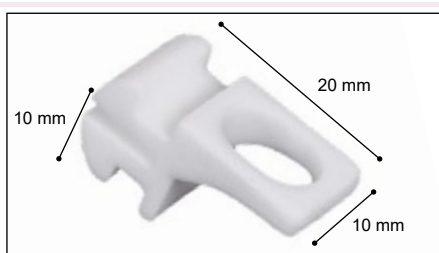

REF	∅	U	€	€	cm
D.07		500	0,064 €	0,077 €	

Accesorios / Accessories / Accessoires



<p>Rollo Cinta Acordeón con Automáticos</p> <p>Ruffle-tape roll with snap-buttons / Rouleau ruban accordéon avec système automat</p>		<table border="1"> <thead> <tr> <th>REF</th> <th>∅</th> <th>U</th> <th>€</th> <th>€</th> <th>cm</th> </tr> </thead> <tbody> <tr> <td>D.111</td> <td></td> <td>1</td> <td>203,28 €</td> <td>233,77 €</td> <td></td> </tr> </tbody> </table> <p>* 1 rollo contiene 840 corchetes / Roll of 840 Snaps / Rouleau de 840 crochets.</p>	REF	∅	U	€	€	cm	D.111		1	203,28 €	233,77 €	
REF	∅	U	€	€	cm									
D.111		1	203,28 €	233,77 €										
<p>Rollo Corredera Acordeón</p> <p>Corded gliders roll / Rouleau glisseurs acordeón</p>		<table border="1"> <thead> <tr> <th>REF</th> <th>∅</th> <th>U</th> <th>€</th> <th>€</th> <th>cm</th> </tr> </thead> <tbody> <tr> <td>D.112</td> <td></td> <td>1</td> <td>151,20 €</td> <td>173,88 €</td> <td></td> </tr> </tbody> </table> <p>* 1 rollo contiene 1000 correderas / Roll of 1000 runners / Rouleau de 1000 glisseurs.</p>	REF	∅	U	€	€	cm	D.112		1	151,20 €	173,88 €	
REF	∅	U	€	€	cm									
D.112		1	151,20 €	173,88 €										
<p>Rollo Corredera Onda Perfecta</p> <p>Perfect wave runners roll / Rouleau de glisseur "onde parfaite"</p>		<table border="1"> <thead> <tr> <th>REF</th> <th>∅</th> <th>U</th> <th>€</th> <th>€</th> <th>cm</th> </tr> </thead> <tbody> <tr> <td>D.113</td> <td></td> <td>1</td> <td>151,20 €</td> <td>173,38 €</td> <td></td> </tr> </tbody> </table> <p>* 1 rollo contiene 1000 correderas / Roll of 1000 runners / Rouleau de 1000 glisseurs.</p>	REF	∅	U	€	€	cm	D.113		1	151,20 €	173,38 €	
REF	∅	U	€	€	cm									
D.113		1	151,20 €	173,38 €										
<p>Rollo Corredera Onda Perfecta</p> <p>Perfect wave runners roll / Rouleau de glisseur "onde parfaite"</p>		<table border="1"> <thead> <tr> <th>REF</th> <th>∅</th> <th>U</th> <th>€</th> <th>€</th> <th>cm</th> </tr> </thead> <tbody> <tr> <td>D.114</td> <td></td> <td>1</td> <td>151,20 €</td> <td>173,88 €</td> <td></td> </tr> </tbody> </table> <p>* 1 rollo contiene 1000 correderas / Roll of 1000 runners / Rouleau de 1000 glisseurs.</p>	REF	∅	U	€	€	cm	D.114		1	151,20 €	173,88 €	
REF	∅	U	€	€	cm									
D.114		1	151,20 €	173,88 €										
<p>Embellecedor para empalme Capri</p> <p>Decorative joiner Capri / Raccordeur decoratif Capri</p>		<table border="1"> <thead> <tr> <th>REF</th> <th>∅</th> <th>U</th> <th>€</th> <th>€</th> <th>cm</th> </tr> </thead> <tbody> <tr> <td>H.08A</td> <td></td> <td>10</td> <td>9,88 €</td> <td>11,36 €</td> <td></td> </tr> </tbody> </table> <p>NEW</p>	REF	∅	U	€	€	cm	H.08A		10	9,88 €	11,36 €	
REF	∅	U	€	€	cm									
H.08A		10	9,88 €	11,36 €										
<p>Alargador Soporte</p> <p>Bracket extender / Extendeur pour bracket</p>		<table border="1"> <thead> <tr> <th>REF</th> <th>∅</th> <th>U</th> <th>€</th> <th>€</th> <th>cm</th> </tr> </thead> <tbody> <tr> <td>R.2001AS</td> <td></td> <td>10</td> <td>6,18 €</td> <td>7,11 €</td> <td></td> </tr> </tbody> </table>	REF	∅	U	€	€	cm	R.2001AS		10	6,18 €	7,11 €	
REF	∅	U	€	€	cm									
R.2001AS		10	6,18 €	7,11 €										
<p>Adaptador rieles madera</p> <p>Wood track adaptador / Adapteur pour rails en bois</p>		<table border="1"> <thead> <tr> <th>REF</th> <th>∅</th> <th>U</th> <th>€</th> <th>€</th> <th>cm</th> </tr> </thead> <tbody> <tr> <td>H.28</td> <td></td> <td>10</td> <td>2,78 €</td> <td>3,20 €</td> <td></td> </tr> </tbody> </table>	REF	∅	U	€	€	cm	H.28		10	2,78 €	3,20 €	
REF	∅	U	€	€	cm									
H.28		10	2,78 €	3,20 €										
<p>Muestra Riel Capri</p> <p>Demo Sample Capri track / Échantillon Rail Capri</p>		<table border="1"> <thead> <tr> <th>REF</th> <th>∅</th> <th>U</th> <th>€</th> <th>€</th> <th>cm</th> </tr> </thead> <tbody> <tr> <td>M.250</td> <td></td> <td>1</td> <td></td> <td>22,06 €</td> <td></td> </tr> </tbody> </table>	REF	∅	U	€	€	cm	M.250		1		22,06 €	
REF	∅	U	€	€	cm									
M.250		1		22,06 €										



ALTRAN[®]

CURTAIN DECORATION SYSTEMS



Wengué
Wenge



Cerezo
Cherry / Merisier





Blanco Brillo
Glossy White / Blanc Verni



Negro Brillo
Glossy Black / Noir Verni

 Riel funcional y moderno con melaminas de diseños intercambiables y adaptables a cualquier decoración. Con la Colección Inter damos un paso al frente para solucionar la creación de diferentes ambientes con un solo riel. Contamos con el aire moderno de su diseño que lo asemeja a una galería, también con la adaptabilidad del color para crear diferentes ambientes y además contamos, con un perfil que deja oculto el sistema de correderas. De este modo, podremos colocar cualquier cortina con cualquier sistema de corredera de la forma más simple y sencilla. Las melaminas (disponible para la venta también por piezas sueltas), permiten cambiar el color de la habitación en cualquier momento.

 Practical and modern rail, made of aluminium including different interchangeable decorative melamine that can match with all decorations. With Inter rail we take a step forward to solve different environments creations with one model of rail. The modern look of its design resembles it to a pelmet and the adaptability of colours allows to create different environments. Its particular profile system hides gliders so we can put any curtain very simply and easily. The melamine (also available for sale in spare parts) , gives us the chance to change the colour of the room at any time.

 Rail décoratif pratique et moderne, en aluminium avec différents mélamines décoratives interchangeables que peuvent reconstruire toutes les décorations. Avec le rail Inter nous faisons un pas en avant pour résoudre différents environnements de décoration. Le look moderne de son design ressemble à un bandeau et la capacité d'adaptation des couleurs permet de créer des environnements différents. Son système de profil particulier cache les glisseurs afin qu'est possible d'installer tout rideau très simplement et facilement. La mélamine (également disponible à la vente en pièces détachées), nous donne la possibilité de changer la couleur de la chambre à tout moment.

Conjuntos Completos INTER /
Complete sets INTER /
Kits complets INTER

	00AP		01AP		02AP		03AP
Wengué Wenge Wenge		Cerezo Cherry Merisier		Blanco Brillo Glossy White Blanc Verni		Negro Brillo Glossy Black Noir Verni	

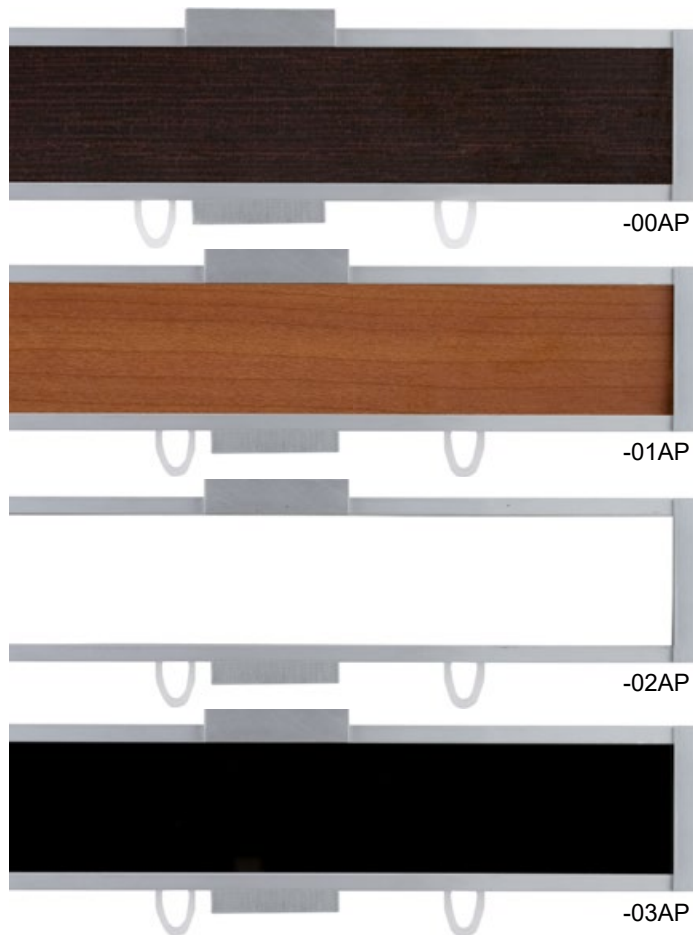

REF	-00AP	-01AP	-02AP	-03AP					
K.15811001-	-00AP	-01AP	-02AP	-03AP	2	10	1	105,16 €	100
K.15811501-	-00AP	-01AP	-02AP	-03AP	2	16	1	112,57 €	150
K.15812001-	-00AP	-01AP	-02AP	-03AP	2	20	1	119,79 €	200
K.15812501-	-00AP	-01AP	-02AP	-03AP	2	26	1	127,20 €	250
K.15813001-	-00AP	-01AP	-02AP	-03AP	3	30	1	166,08 €	300
*K.15813501-	-00AP	-01AP	-02AP	-03AP	3	36	1	193,36 €	350
*K.15814001-	-00AP	-01AP	-02AP	-03AP	3	40	1	200,58 €	400
*K.15814501-	-00AP	-01AP	-02AP	-03AP	3	46	1	207,99 €	450
*K.15815001-	-00AP	-01AP	-02AP	-03AP	3	50	1	215,20 €	500
*K.15815501-	-00AP	-01AP	-02AP	-03AP	3	56	1	222,61 €	550

Laminado Decorativo / Decorative laminales / Laminé Decoratif

Wengué
Wenge /
Wenge

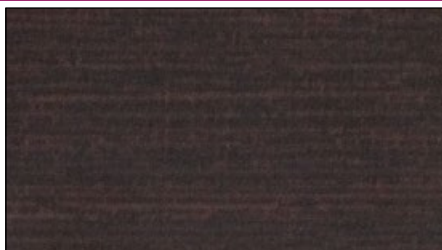

REF					
V.100C0040		10	9,70 €	11,16 €	305

Cerezo
Cherry /
Merisier

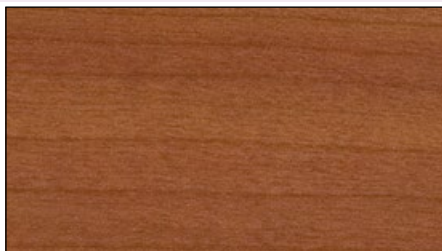

REF					
V.101C0040		10	9,70 €	11,16 €	305

Blanco Brillo
Glossy White/
Blanc Verni



REF					
V.102C0040		10	9,70 €	11,16 €	305

Negro Brillo
Glossy Black /
Noir Verni

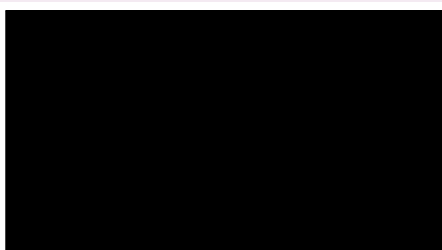

REF					
V.103C0040		10	9,70 €	11,16 €	305

Contenido del Kit / Kit components / Composants du Kit

 Conjuntos Sencillos : 2 terminales, 2 soportes, perfil de aluminio, tope y correderas.
Los conjuntos de 3 metros se sirven con 3 soportes.

 Single sets : 2 finials, 2 brackets, aluminium track, end-stop & runners.
All sets with a length 3 meters are supplied with 3 brackets.

 Kits simples : 2 embouts, 2 supports, rail aluminium, vis d'arrêt et glisseur.
Tous les kits de plus de 3 mètres contiennent 3 supports.

* Se sirven empalmados.

* Supplied in 2 halve.

* Fourni en 2 parties.

Posibilidades de montaje / Installation possibilities / Possibilités de montage

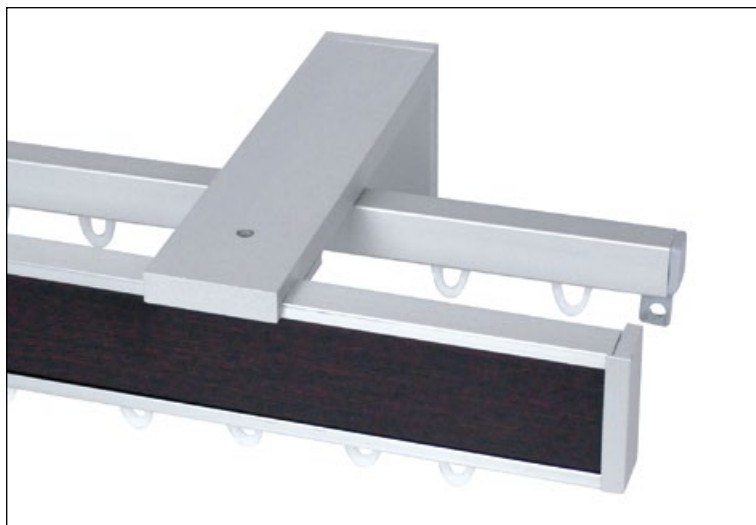

 El Riel Inter permite combinar gracias a su perfil doble, un magnífico riel decorativo junto a un práctico riel técnico. En este ejemplo podemos ver la combinación de Riel Argent y Riel Inter. Cualquier estancia se verá enriquecida con la elegante decoración del Riel Inter, mientras que el Riel Argent aumenta sus posibilidades a la hora de buscar soluciones decorativas. /

 The Inter track offers the possibility of merging thanks to its special double profile, one unique example of decorative splendor provided by the Inter track together with the technical and practical nature of the Argent Track. Any space will be enriched with the decorative elegance of the Inter Rail whereas the Argent rail will increase the possibilities regarding new decorative solutions. /

 Le rail Inter vous permet de fusionner grâce à son profil double, un exemple unique de la splendeur décorative avec un rail technique et pratique. Dans cet exemple on peut vérifier la fusion du Riel Argent et Inter. N'importe quel espace sera enrichi avec l'élégance décorative du rail Inter, tandis que le rail Argent augmente les chances d'obtenir nouvelles solutions décoratives.

Accesorios / Accessories / Accessoires

Perfil Inter
Inter Profile /
Inter Rail

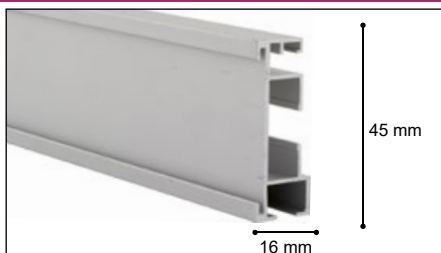

REF	∅	U	€	€	cm
C.12039AP		10	11,86 €/m	13,64 €/m	600

Tapa
Encap/
Bouchon

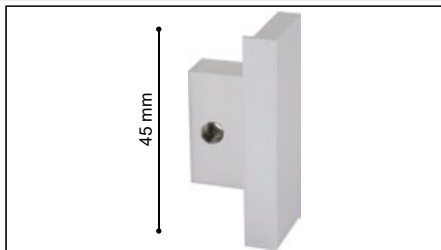

REF	∅	U	€	€	cm
D.84AP		10	6,74 €	7,75 €	

Corredera
Runner/
Glisseur

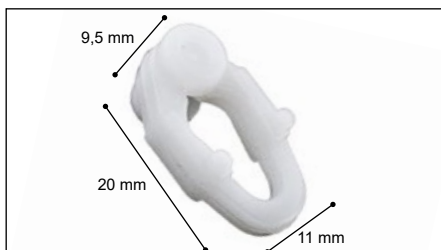

REF	∅	U	€	€	cm
D.23		1000	0,082 €	0,098 €	

Accesorios / Accessories / Accessoires

Soporte Pared

Wall Bracket/
Support Mur

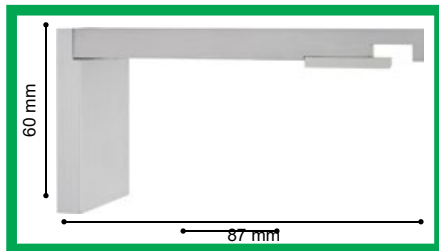

REF	∅	U	€	€	cm
N.120AP		10	27,54 €	31,67 €	

* Soporte incluido en el Kit Sencillo /
Bracket supplied in the Single Kit / Support fourni dans le Simple Kit.

Soporte Largo

Long Wall Bracket/
Support Mur Long

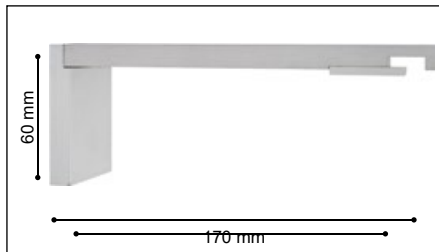

REF	∅	U	€	€	cm
N.122AP		10	34,24 €	39,38 €	

Soporte Doble

Double
Wall Bracket/
Support Mur Doble

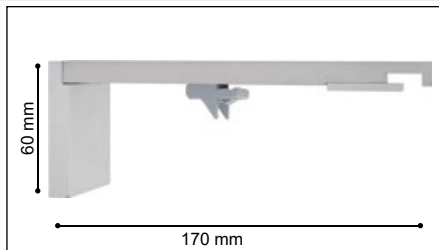

REF	∅	U	€	€	cm
O.122AP		10	34,22 €	39,35 €	

Soporte Techo

Ceiling Bracket/
Support Plafond

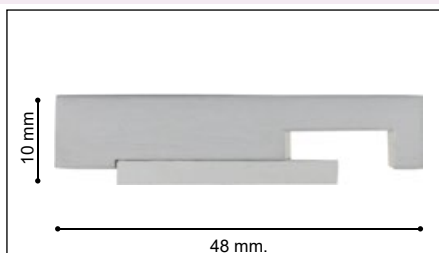

REF	∅	U	€	€	cm
N.121AP		10	15,34 €	17,64 €	

Soporte Techo

Ceiling Bracket/
Support Plafond



REF	∅	U	€	€	cm
D.50		50	2,12 €	2,44 €	

Empalme

Splice/
Raccordeur

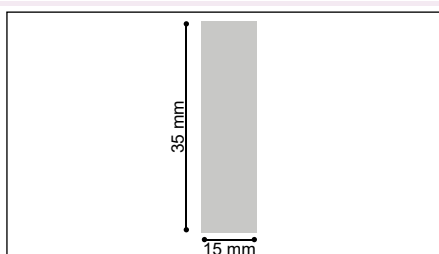

REF	∅	U	€	€	cm
D.820		10	7,58 €	8,72 €	

Tornillo Tope

End-Stop/
Vis d'arrêt



REF	∅	U	€	€	cm
D.784		10	0,226 €	0,271 €	

Muestra
Riel Inter

Demo Sample
Inter track /
Échantillon
Rail Inter

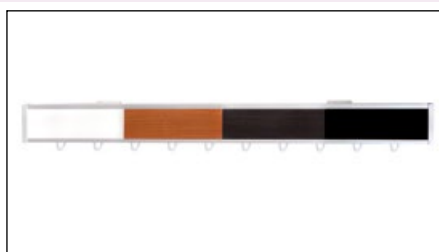

REF	∅	U	€	€	cm
M.252		1		44,12 €	

Riel Decorativo con iluminación LED / Rail with LED illumination / Rail Décoratif avec éclairage LED



Riel vanguardista, con iluminación interior, desarrollado con perfiles de primera calidad acrílicos y de aluminio. El Riel más innovador del mercado, el Riel de Led. Por un lado, es un sistema capaz de solucionar cualquier necesidad decorativa, por el otro, es el sistema de iluminación más avanzado que se puede encontrar. Gracias a este novedoso riel, podrá disfrutar de una acogedora luz cálida en la cabecera de sus cortinas. Le ayudará a decorar su hogar empleando la iluminación de tecnología led como elemento principal. El Riel de Led, está desarrollado pensando en cualquier uso o ubicación posible, por eso está fabricado con materiales de calidad que garantizan su seguridad y fiabilidad, además cuenta con Soportes capaces de adaptarse a todas las opciones de montaje.

Vanguardrail, with interior lighting, developed with high quality acrylic and aluminium materials. LEDS rail is the most innovative rail in the market. On the one hand, is a system able to solve any decorative need, on the other, is the most advanced lighting system that can be found. Thanks to this new track, you can enjoy a cosy warm light at the top of your curtains. It will help you to decorate your home using LED lighting technology as the main element. The Led rail is developed considering any use or possible location and it is manufactured with high quality materials to ensure safety and reliability. Moreover its supports are able to accommodate all installation options.

Avant-garde rail, avec lumière intérieur, élaboré avec matériel acrylique et d'aluminium de haute qualité. LEDS est le rail le plus innovateur sur le marché qui est capable de résoudre toutes les besoins de décoration avec un système de lumière très avancé. Merci à cette rail, vous pourrez profiter d'une lumière chaude et confortable en haut de vos rideaux. Il vous aidera à décorer votre maison en utilisant la technologie LED comme l'élément principal. Le rail LED est fabriqué avec des matériaux de haute qualité pour assurer la sécurité et la fiabilité. De plus ses supports ont été développés en mesure de s'adapter à toutes les options d'installation.

Contenido del Kit / Kit components / Composants du Kit

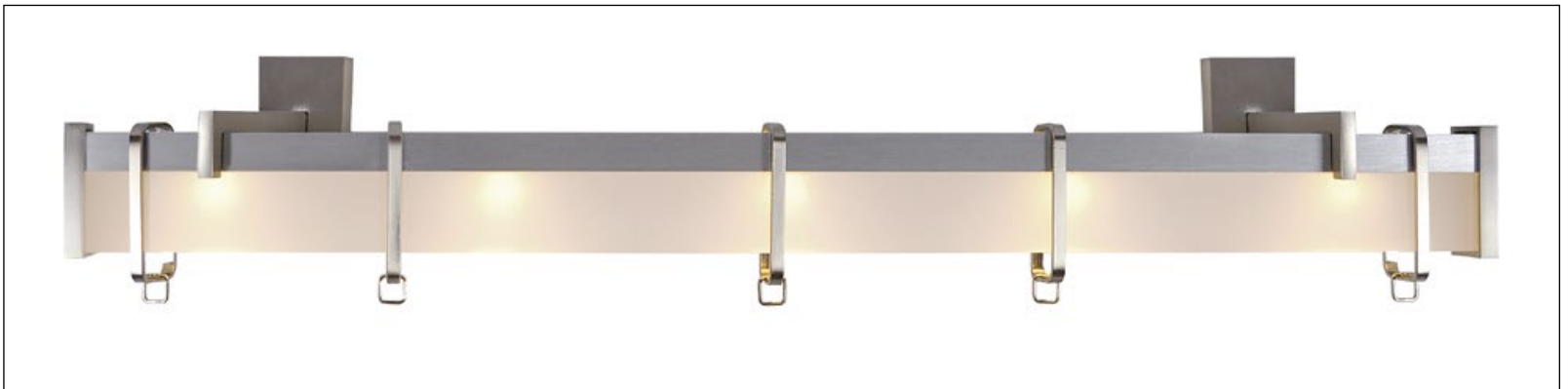

Contenido Kit

Perfil de aluminio, riel de metacrilato, leds, 2 tapas, transformador y cable de conexión.
Aluminium profile, acrylic profile, led strips, 2 endcaps adaptor & cord connector.
Rail en aluminium, profil acrilique, tiges de leds, 2 bouchons, transformateur & câble de connexion.

Es recomendable utilizar 3 soportes en conjuntos de más de 2 m.
It is advisable to use 3 brackets in lengths over 2 meters.

Il est recommandable d'utiliser 3 support pour des garnitures de plus de 2 mètres.

Información General / General Information / Informations Générales

- Los "leds" son diodos semiconductores que consumen aproximadamente un 75% menos energía que las bombillas/tubos convencionales de iluminación.
- Emiten muy poco calor con lo cual no dañan ni queman los objetos cercanos.
- Son muy duraderos al no tener piezas móviles y resisten muy bien los golpes.
- Al no contener mercurio, a diferencia de los sistemas convencionales, no son perjudiciales para el medio ambiente.
- La duración media de los leds es de 20.000 horas de luz, en condiciones normales de uso.

- Leds are semi-conductor diodes that consume approximately 75% less energy than conventional light bulbs/tubes.
- They produce very little heat and therefore do not harm objects that are near them.
- They are very durable because they do not contain movable parts and they are highly shock-resistant.
- Contrary to other conventional lighting systems, they do not contain mercury so they are not harmful to the environment.
- The average life of the leds strips is 20.000 light hours under normal conditions of use.

- Les leds sont des diodes semi-conductives qui consomment en moyenne 75% moins d'énergie que des ampoules traditionnelles.
- Elles émettent très peu de chaleur, elles ne produisent donc aucun dommage aux objets aux alentours.
- Elles sont très solides et résistent aux coups.
- Comme elles ne contiennent pas de mercure, elles ne sont pas nocives pour l'environnement.
- La durée moyenne de vie d'une led est de 20.000 heures de lumières dans des conditions d'utilisations normales.

Accesorios / Accessories / Accessoires

Kit Riel Leds

Leds track kit /
Kit rail Leds

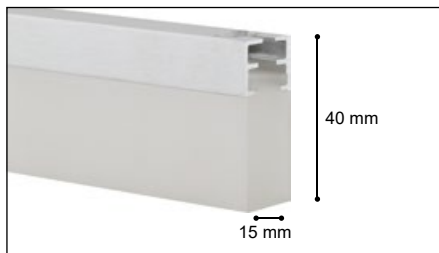

REF	∅	U	€	€	cm
J.F4200		1		301,16 €	200
J.F4300		1		417,88 €	300

Soporte Frontal

Wall bracket /
Support mur

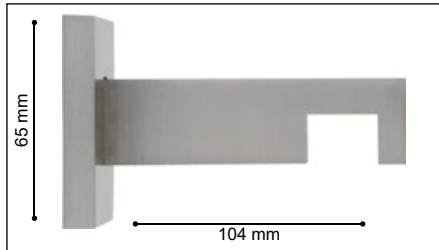

REF	∅	U	€	€	cm
J.F400		10	16,74 €	19,25 €	

Soporte Largo

Long wall bracket /
Support mur long

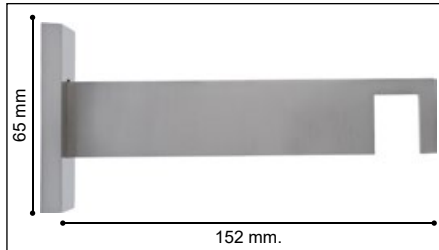

REF	∅	U	€	€	cm
J.F409		10	18,78 €	21,60 €	

Soporte Techo

Ceiling bracket /
Support plafond

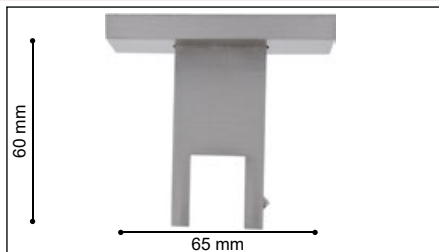

REF	∅	U	€	€	cm
J.F401		10	14,96 €	17,20 €	

Soporte Doble

Double wall bracket /
Support mur double

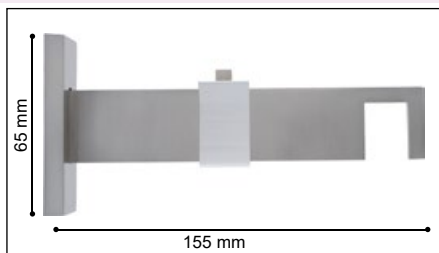

REF	∅	U	€	€	cm
J.F402		10	21,60 €	24,84 €	

Tapas Acero

Steel endcaps /
Bouchons acier

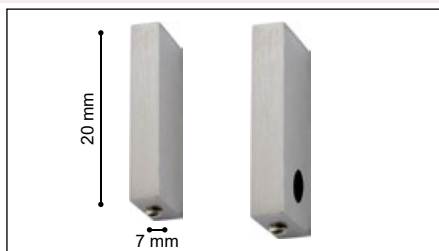

REF	∅	U	€	€	cm
J.F403		10	15,16 €/par	17,43 €/par	

Anilla

Ring /
Anneaux

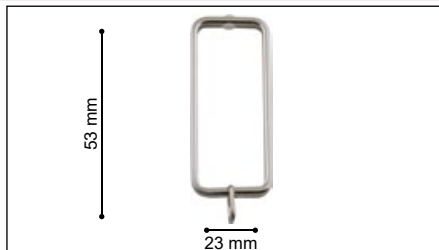

REF	∅	U	€	€	cm
J.F404		100	1,72 €	1,98 €	

Tira de Leds

Led strips /
Tiges de Leds

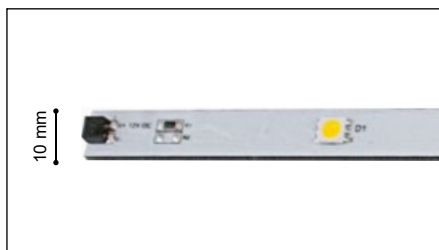

REF	∅	U	€	€	cm
J.F405		10	33,66 €	38,71 €	50

Accesorios / Accessories / Accessoires

Transformador

AC Adaptor /
Transformateur



REF	∅	U	€	€	cm
J.F407		1		29,02 €	

Cable de conexión

Connector cord /
Câble de connexion



REF	∅	U	€	€	cm
J.F406		10	4,38 €	5,040 €	

Interruptor de techo

Ceiling switch /
Interrupteur
du plafond



REF	∅	U	€	€	cm
J.F408		10	11,50 €	13,23 €	

Embellecedor soporte
leds para interruptor

Decorative
bracket cover /
Revêtement
décoratif

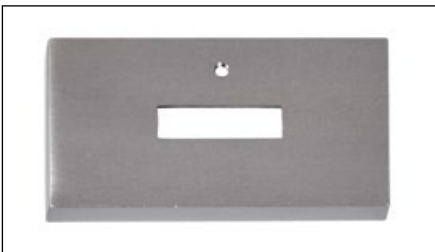

REF	∅	U	€	€	cm
J.F410		10	18,78 €	21,60 €	

RIEL LED

ILUMINAMOS Y DECORAMOS TU HOGAR





Cuando el estilo y la calidad se unen, el resultado es éste.
Diseñado en España y fabricado con el mejor aluminio.
Decoramos tu vida, aportamos valor a tu hogar.

RIEL SLIM

ANILLAS, ONDA PERFECTA, CORREDERAS... ¡ESO ES DISEÑO!



■ **Opción con Corredera Onda Perfecta /**

Option Perfect Wave Gliders /
Option avec Glisseurs Onde Parfaite

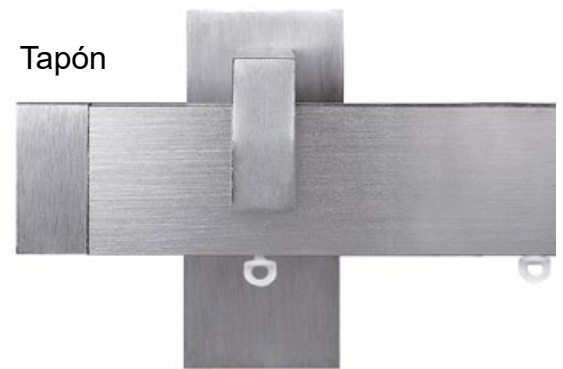

■ **Opción con correderas /**

Option with gliders /
Option avec glisseurs

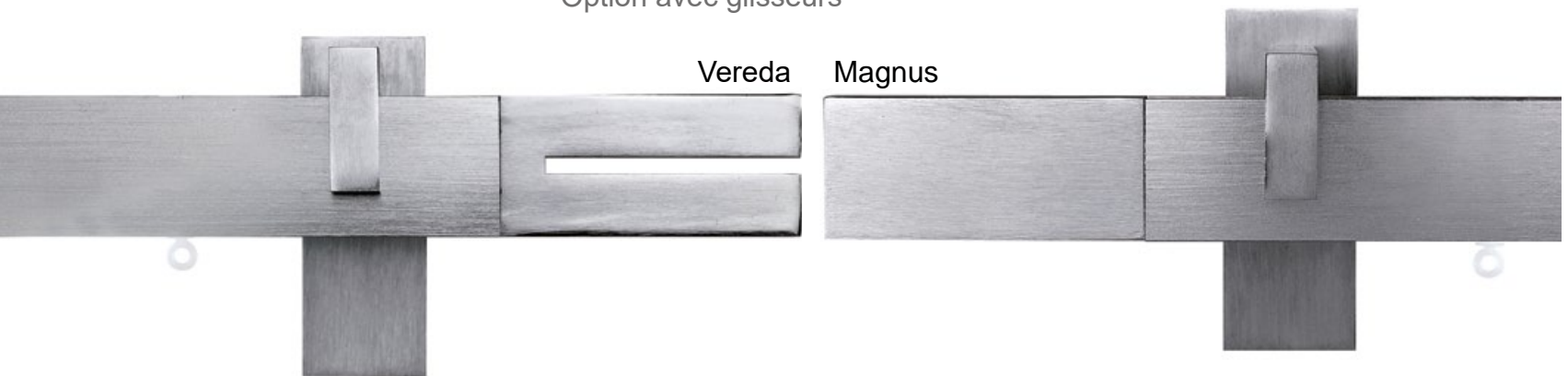

■ **Opción con Anillas /**

Option with rings /
Option avec anneaux

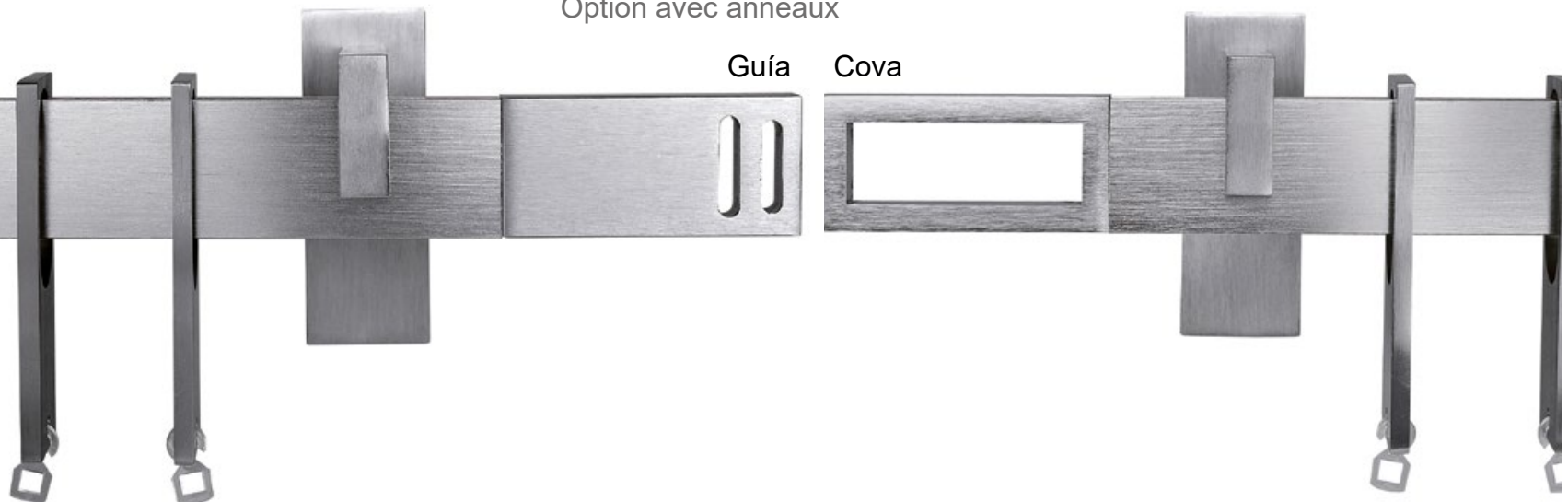

 Riel de interior y exterior, con acabado en aluminio cromatizado de aspecto cepillado que le da un toque realmente diferente de alto valor estético.

Sin lugar a dudas, es el Riel moderno por excelencia y a la vez, es una barra decorativa si se instala con anillas. Su estética y su diseño, el acabado de sus detalles y el tratamiento del color, hacen de este riel, un riel para los más exigentes.

Cuenta además con soportes de alto valor decorativo que permiten cualquier tipo de instalación que necesite.

 Indoor and outdoor coated track with an original brushed-aluminum finish offering a "different touch" of unquestionable aesthetic value.

Undoubtedly, it is the quintessential modern rail, and at the same time is a decorative pole when used with its modern rectangular rings. His design, finish detail and colour treatment make this rail, a rail for the most demanding. It also has high decorative value brackets that allow any installation need.

Available in steel colour and in three lengths.

 Rail pour intérieur et extérieur, en aluminium finition brossée qui apporte une touche vraiment différente de haute valeur esthétique.

Sans aucun doute, c'est le rail moderne par excellence, et en même temps est un tringle décorative quand il est utilisé avec les anneaux rectangulaires modernes. Sa conception, le détail de sa finition et le traitement des couleurs font de ce rail, un rail pour les plus exigeants.

Il a également supports de haute valeur décorative qui permettent tout besoin d'installation.

Conjuntos Sencillos completos. Opción con “Corredera D.998” o “Anilla H.02AC” /
 Complete Single sets. Option with “gliders D.998” or “Rings H.02AC” /
 Kits Simples complets. Option avec “glisseurs D.998” ou “Anneaux H.02AC”

Guía



	REF						
D.998	K.13100150AC	2	16	-	1	82,73 €	150
	K.13100200AC	2	20	-	1	92,84 €	200
	K.13100300AC	3	30	-	1	128,11 €	300
H.02AC	K.13000150AC	2	-	16	1	144,14 €	150
	K.13000200AC	2	-	20	1	169,95 €	200
	K.13000300AC	3	-	30	1	244,44 €	300

Cova



	REF						
D.998	K.13500150AC	2	16	-	1	82,73 €	150
	K.13500200AC	2	20	-	1	92,84 €	200
	K.13500300AC	3	30	-	1	128,11 €	300
H.02AC	K.13400150AC	2	-	16	1	144,14 €	150
	K.13400200AC	2	-	20	1	169,95 €	200
	K.13400300AC	3	-	30	1	244,44 €	300

Vereda

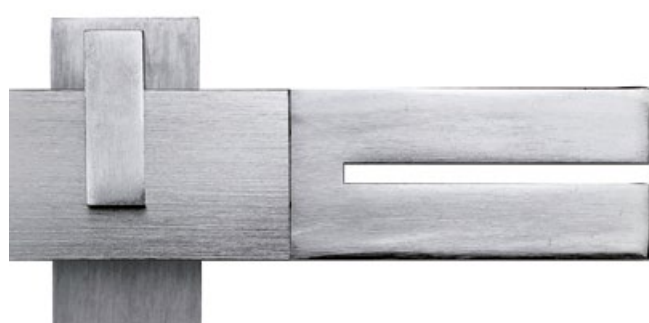

	REF						
D.998	K.13300150AC	2	16	-	1	82,73 €	150
	K.13300200AC	2	20	-	1	92,84 €	200
	K.13300300AC	3	30	-	1	128,11 €	300
H.02AC	K.13200150AC	2	-	16	1	144,14 €	150
	K.13200200AC	2	-	20	1	169,95 €	200
	K.13200300AC	3	-	30	1	244,44 €	300

Magnus



	REF						
D.998	K.12900150AC	2	16	-	1	82,73 €	150
	K.12900200AC	2	20	-	1	92,84 €	200
	K.12900300AC	3	30	-	1	128,11 €	300
H.02AC	K.12800150AC	2	-	16	1	144,14 €	150
	K.12800200AC	2	-	20	1	169,95 €	200
	K.12800300AC	3	-	30	1	244,44 €	300

Tapón

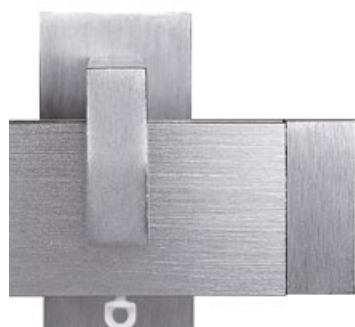

	REF						
D.998	K.13700150AC	2	16	-	1	72,93 €	150
	K.13700200AC	2	20	-	1	83,05 €	200
	K.13700300AC	3	30	-	1	118,31 €	300
H.02AC	K.13600150AC	2	-	16	1	134,34 €	150
	K.13600200AC	2	-	20	1	160,15 €	200
	K.13600300AC	3	-	30	1	234,65 €	300

Conjuntos Dobles completos. Opción con "Corredera D.998" o "Anilla H.02AC" /
 Complete Double sets. Option with "gliders D.998" or "Rings H.02AC" /
 Kits Doubles complets. Option avec "glisseurs D.998" ou "Anneaux H.02AC"

Guía

	REF						
D.998	K.13122150AC	2	32	-	1	142,92 €	150
	K.13122200AC	2	40	-	1	163,15 €	200
	K.13122300AC	3	60	-	1	222,41 €	300
H.02AC	K.13022150AC	2	-	32	1	265,74 €	150
	K.13022200AC	2	-	40	1	317,35 €	200
	K.13022300AC	3	-	60	1	455,08 €	300

Cova

	REF						
D.998	K.13522150AC	2	32	-	1	142,92 €	150
	K.13522200AC	2	40	-	1	163,15 €	200
	K.13522300AC	3	60	-	1	222,41 €	300
H.02AC	K.13422150AC	2	-	32	1	265,74 €	150
	K.13422200AC	2	-	40	1	317,35 €	200
	K.13422300AC	3	-	60	1	455,08 €	300

Vereda

	REF						
D.998	K.13322150AC	2	32	-	1	142,92 €	150
	K.13322200AC	2	40	-	1	163,15 €	200
	K.13322300AC	3	60	-	1	222,41 €	300
H.02AC	K.13222150AC	2	-	32	1	265,74 €	150
	K.13222200AC	2	-	40	1	317,35 €	200
	K.13222300AC	3	-	60	1	455,08 €	300

Magnus

	REF						
D.998	K.12922150AC	2	32	-	1	142,92 €	150
	K.12922200AC	2	40	-	1	163,15 €	200
	K.12922300AC	3	60	-	1	222,41 €	300
H.02AC	K.12822150AC	2	-	32	1	265,74 €	150
	K.12822200AC	2	-	40	1	317,35 €	200
	K.12822300AC	3	-	60	1	455,08 €	300

Tapón

	REF						
D.998	K.13722150AC	2	32	-	1	123,32 €	150
	K.13722200AC	2	40	-	1	143,55 €	200
	K.13722300AC	3	60	-	1	202,81 €	300
H.02AC	K.13622150AC	2	-	32	1	246,15 €	150
	K.13622200AC	2	-	40	1	297,76 €	200
	K.13622300AC	3	-	60	1	435,48 €	300

I.121I - Incremento corredera para Onda Perfecta (D.121 + D.120): 7,44 €/m PVP
I.122I - Incremento corredera para Onda Perfecta (D.122 + D.120): 7,44 €/m PVP

I.121I - Perfect Wave assembled (D.121 + D.120): 7,44 €/m SRP
I.122I - Perfect Wave assembled (D.122 + D.120): 7,44 €/m SRP

I.121I - Onde parfaite monté (D.121 + D.120): 7,44 €/m PVP
I.122I - Onde parfaite monté (D.122 + D.120): 7,44 €/m PVP

Contenido del Kit / Kit components / Composants du Kit

Conjuntos Sencillos : 2 terminales, 2 soportes, perfil de aluminio, tope y correderas o anillas.
Conjuntos Dobles : 2 terminales, 2 soportes, perfil de aluminio, tope y correderas o anillas.
Los conjuntos de 3 metros se sirven con 3 soportes.

Single Sets : 2 finials, 2 brackets, aluminium track, end-stop & runners or rings.
Double Sets : 2 finials, 2 brackets, aluminium track, end-stop & runners or rings.
All sets with a length 3 meters are supplied with 3 brackets.

Kits Simples : 2 embouts, 2 supports, rail aluminium, vis d'arrêt et glisseur ou anneaux.
Kits Doubles : 2 embouts, 2 supports, rail aluminium, vis d'arrêt et glisseur ou anneaux..
Tous les kits de plus de 3 mètres contiennent 3 supports.

Accesorios / Accessories / Accessoires

<p>Perfil Aluminio Aluminium Track / Rail Aluminium</p>	<table border="1"> <thead> <tr> <th>REF</th> <th>∅</th> <th></th> <th></th> <th></th> <th></th> </tr> </thead> <tbody> <tr> <td>C.12031AC150</td> <td></td> <td>10</td> <td>24,10 €</td> <td>27,72 €</td> <td>150</td> </tr> <tr> <td>C.12031AC200</td> <td></td> <td>10</td> <td>32,46 €</td> <td>37,33 €</td> <td>200</td> </tr> <tr> <td>C.12031AC300</td> <td></td> <td>10</td> <td>48,18 €</td> <td>55,41 €</td> <td>300</td> </tr> </tbody> </table>	REF	∅					C.12031AC150		10	24,10 €	27,72 €	150	C.12031AC200		10	32,46 €	37,33 €	200	C.12031AC300		10	48,18 €	55,41 €	300
REF	∅																								
C.12031AC150		10	24,10 €	27,72 €	150																				
C.12031AC200		10	32,46 €	37,33 €	200																				
C.12031AC300		10	48,18 €	55,41 €	300																				
<p>Terminal Guía finial / embout</p>	<table border="1"> <thead> <tr> <th>REF</th> <th>∅</th> <th></th> <th></th> <th></th> <th></th> </tr> </thead> <tbody> <tr> <td>P.53AC</td> <td></td> <td>10</td> <td>8,60 €</td> <td>9,89 €</td> <td></td> </tr> </tbody> </table>	REF	∅					P.53AC		10	8,60 €	9,89 €													
REF	∅																								
P.53AC		10	8,60 €	9,89 €																					
<p>Terminal Cova finial / embout</p>	<table border="1"> <thead> <tr> <th>REF</th> <th>∅</th> <th></th> <th></th> <th></th> <th></th> </tr> </thead> <tbody> <tr> <td>P.52AC</td> <td></td> <td>10</td> <td>8,60 €</td> <td>9,89 €</td> <td></td> </tr> </tbody> </table>	REF	∅					P.52AC		10	8,60 €	9,89 €													
REF	∅																								
P.52AC		10	8,60 €	9,89 €																					
<p>Terminal Vereda finial / embout</p>	<table border="1"> <thead> <tr> <th>REF</th> <th>∅</th> <th></th> <th></th> <th></th> <th></th> </tr> </thead> <tbody> <tr> <td>P.51AC</td> <td></td> <td>10</td> <td>8,60 €</td> <td>9,89 €</td> <td></td> </tr> </tbody> </table>	REF	∅					P.51AC		10	8,60 €	9,89 €													
REF	∅																								
P.51AC		10	8,60 €	9,89 €																					

Accesorios / Accessories / Accessoires

Terminal
Magnus
finial /
embout

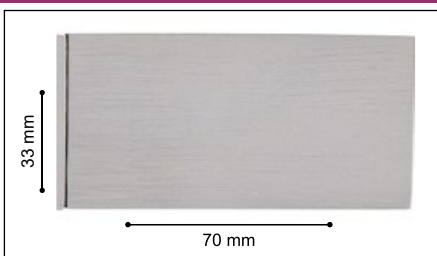

REF	∅	U	€	€ ¹	cm
P.50AC		10	8,60 €	9,89 €	

Terminal
Tapón
finial /
embout

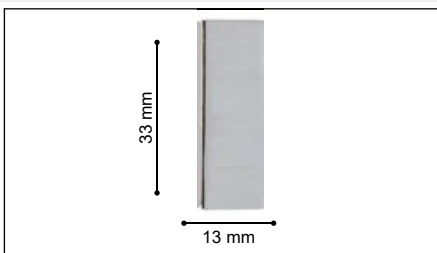

REF	∅	U	€	€ ¹	cm
P.49AC		10	4,34 €	4,99 €	

Empalme
Splice /
Raccordeur

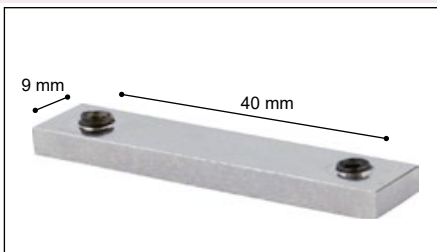

REF	∅	U	€	€ ¹	cm
H.03PL		10	5,02 €	5,77 €	

Soporte Pared
Wall Bracket /
Support Mur

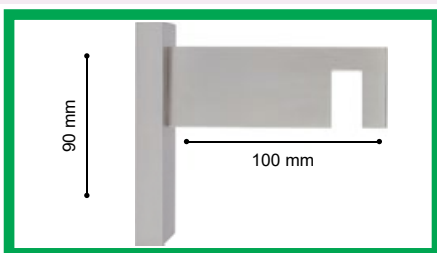

REF	∅	U	€	€ ¹	cm
N.111AC		10	13,86 €	15,94 €	

* Soporte incluido en el Kit Sencillo /
Bracket supplied in the Single Kit / Support fourni dans le Simple Kit.

Soporte Doble
Pared
Double Wall
Bracket /
Support Mur
Double

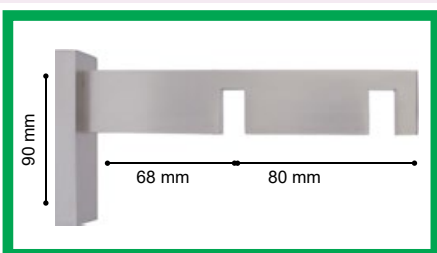

REF	∅	U	€	€ ¹	cm
O.111AC		10	17,92 €	20,61 €	

Alargador Soporte
Extender /
Prolongateur

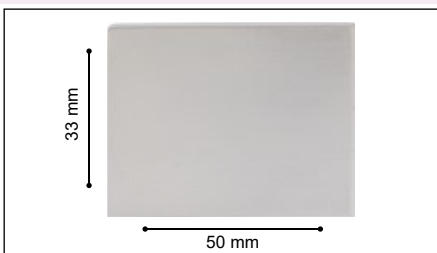

REF	∅	U	€	€ ¹	cm
R.2000AC		10	4,12 €	4,74 €	

Soporte techo
Ceiling bracket /
Support plafond





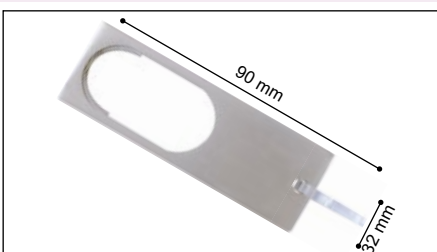

REF	∅	U	€	€ ¹	cm
N.112AC		10	4,16 €	4,78 €	

Anilla
Ring /
Anneaux

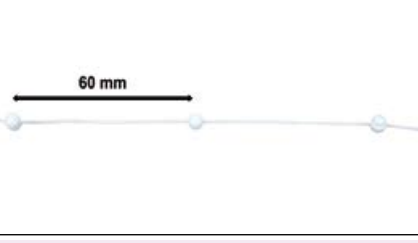
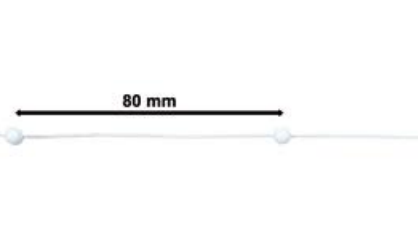

REF	∅	U	€	€ ¹	cm
H.02AC		100	3,52 €	4,05 €	

Accesorios / Accessories / Accessoires

<p>Corredera Tope Static end Runner / Glisseur Flixe</p>		<table border="1"> <thead> <tr> <th>REF</th> <th>∅</th> <th>U</th> <th>€</th> <th>€</th> <th>cm</th> </tr> </thead> <tbody> <tr> <td>D.781</td> <td></td> <td>100</td> <td>0,70 €</td> <td>0,81 €</td> <td></td> </tr> </tbody> </table>	REF	∅	U	€	€	cm	D.781		100	0,70 €	0,81 €	
REF	∅	U	€	€	cm									
D.781		100	0,70 €	0,81 €										
<p>Corredera plástico Static en Runner / Glisseur Flixe</p>		<table border="1"> <thead> <tr> <th>REF</th> <th>∅</th> <th>U</th> <th>€</th> <th>€</th> <th>cm</th> </tr> </thead> <tbody> <tr> <td>D.998</td> <td></td> <td>100</td> <td>0,104 €</td> <td>0,125 €</td> <td></td> </tr> </tbody> </table>	REF	∅	U	€	€	cm	D.998		100	0,104 €	0,125 €	
REF	∅	U	€	€	cm									
D.998		100	0,104 €	0,125 €										
<p>Corredera para Cordón Base Runners for base cord / Coulisses pour cordon de base</p>		<table border="1"> <thead> <tr> <th>REF</th> <th>∅</th> <th>U</th> <th>€</th> <th>€</th> <th>cm</th> </tr> </thead> <tbody> <tr> <td>D.120</td> <td></td> <td>110</td> <td>0,21 €</td> <td>0,25 €</td> <td></td> </tr> </tbody> </table>	REF	∅	U	€	€	cm	D.120		110	0,21 €	0,25 €	
REF	∅	U	€	€	cm									
D.120		110	0,21 €	0,25 €										
<p>100 m Rollo Base Corredera Cordón con paso 60 mm 100 m Roll of base cord for runner, cord with spacing 60 mm / 100 m Rouleau de cordon de base pour coulisse, cordon avec pas 60 mm</p>		<table border="1"> <thead> <tr> <th>REF</th> <th>∅</th> <th>U</th> <th>€</th> <th>€</th> <th>cm</th> </tr> </thead> <tbody> <tr> <td>D.121</td> <td></td> <td>1</td> <td>-</td> <td>409,02 €</td> <td></td> </tr> </tbody> </table>	REF	∅	U	€	€	cm	D.121		1	-	409,02 €	
REF	∅	U	€	€	cm									
D.121		1	-	409,02 €										
<p>100 m Rollo Base Corredera Cordón con paso 80 mm 100 m Roll of base cord for runner, cord with spacing 80 mm / 100 m Rouleau de cordon de base pour coulisse, cordon avec pas 80 mm</p>		<table border="1"> <thead> <tr> <th>REF</th> <th>∅</th> <th>U</th> <th>€</th> <th>€</th> <th>cm</th> </tr> </thead> <tbody> <tr> <td>D.122</td> <td></td> <td>1</td> <td>-</td> <td>409,02 €</td> <td></td> </tr> </tbody> </table>	REF	∅	U	€	€	cm	D.122		1	-	409,02 €	
REF	∅	U	€	€	cm									
D.122		1	-	409,02 €										
<p>Expositor Reil Slim Slim Track Display Board / Presentoir Rail Slim</p>		<table border="1"> <thead> <tr> <th>REF</th> <th>∅</th> <th>U</th> <th>€</th> <th>€</th> <th>cm</th> </tr> </thead> <tbody> <tr> <td>M.3008</td> <td></td> <td>-</td> <td>-</td> <td>105,90 €</td> <td></td> </tr> </tbody> </table>	REF	∅	U	€	€	cm	M.3008		-	-	105,90 €	
REF	∅	U	€	€	cm									
M.3008		-	-	105,90 €										

Barras Modernas

modern collection / collection moderne





Infinity es la colección con mayor número de terminales del mercado.
1 Barra de Acero y 88 Terminales a tu disposición.
Para poder decorar con tu propio gusto debes de tener muchas opciones.

INFINITY COLOR

DETALLES DECORATIVOS EN ACERO

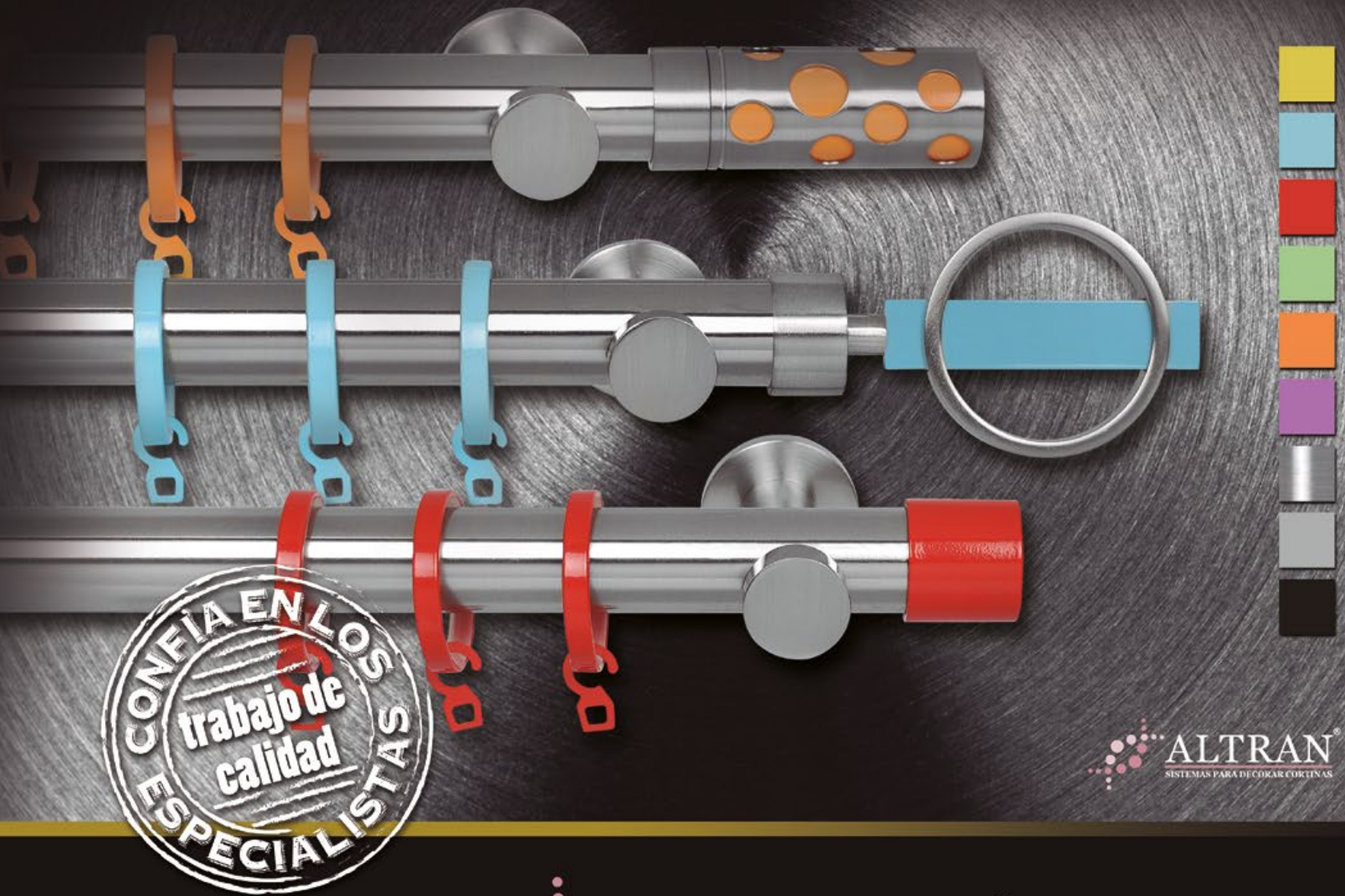



Ángulo negro

Infinity es la colección con un acabado en acero inoxidable más atractiva, amplia, versátil y funcional del mercado.

Le presentamos una colección completísima basada en una barra de primera calidad, anillas y diferentes terminales que cubren infinitas tendencias decorativas formando subcolecciones.

Infinity is the most attractive, versatile and functional stainless steel collection in the market with a very wide range of finials and brackets. It is a complete collection based on a high quality materials including a very wide range of brackets and accessories for any installation required, high quality poles, design rings and a wide range of design finials forming endless decorative trends subcollections.

Infinity est la collection avec finition acier plus intéressante, polyvalente et fonctionnelle sur le marché avec une gamme très large d'embouts et supports.

Elle est une collection complète fabriquée avec matériaux de haute qualité contenant une très large gamme de supports et accessoires pour toutes les installations. La combinaison des tringles de haute qualité, les anneaux, la gamme de supports et la large gamme d'embouts permettent décorations différentes presque sans fin.



Ángulo blanco



Olas negro



Trazos

Infinity ZEN sigue un estilo gráfico basado en formas, trazos y grecas, combinando blancos, negros y acero para dar lugar a una colección muy sofisticada.

Infinity ZEN is a graphic style based on shapes, lines and frets, combining white, black and steel and the result is a very sophisticated collection.

Infinity ZEN est un style graphique basé sur les formes, les lignes et les frettes combinant blanc, noir et acier donne comme résultat une collection très sophistiquée.

Conjuntos completos ZEN /
Complete sets ZEN /
Kits complete ZEN



Ángulo Negro



U	Ø 19 REF K.8318AB	Ø 30 REF K.8307AB	Ø 19/19 REF K.8319AB	Ø 30/19 REF K.8321AB	Q	cm
1	120,18 €	160,70 €	197,98 €	244,40 €	16	150
1	130,04 €	176,30 €	217,72 €	269,86 €	20	200
1	163,99 €	225,08 €	264,43 €	334,35 €	26	250
1	173,26 €	240,97 €	282,97 €	359,51 €	30	300
1	198,65 €	282,19 €	333,75 €	426,12 €	40	400

Ángulo Blanco

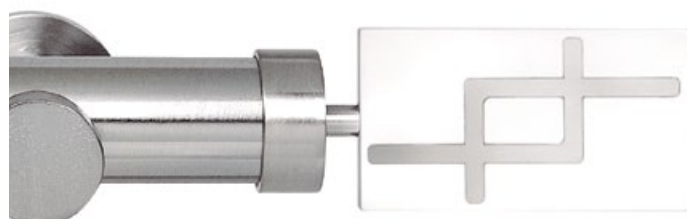

U	Ø 19 REF K.8218ABL	Ø 30 REF K.8207ABL	Ø 19/19 REF K.8219ABL	Ø 30/19 REF K.8221ABL	Q	cm
1	120,18 €	160,70 €	197,98 €	244,40 €	16	150
1	130,04 €	176,30 €	217,72 €	269,86 €	20	200
1	163,99 €	225,08 €	264,43 €	334,35 €	26	250
1	173,26 €	240,97 €	282,97 €	359,51 €	30	300
1	198,65 €	282,19 €	333,75 €	426,12 €	40	400

Olas Negro

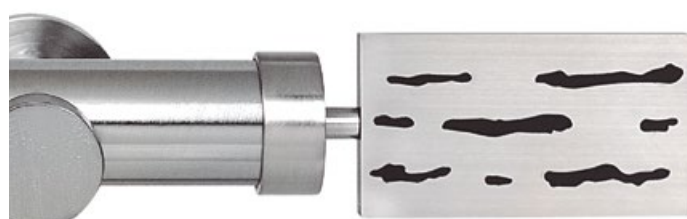

U	Ø 19 REF K.8418AB	Ø 30 REF K.8407AB	Ø 19/19 REF K.8419AB	Ø 30/19 REF K.8421AB	Q	cm
1	122,34 €	162,82 €	202,31 €	248,68 €	16	150
1	132,20 €	178,41 €	222,04 €	274,14 €	20	200
1	166,15 €	227,19 €	268,76 €	338,63 €	26	250
1	175,42 €	243,09 €	287,29 €	363,79 €	30	300
1	200,81 €	284,30 €	338,08 €	430,40 €	40	400

Trazos Blanco

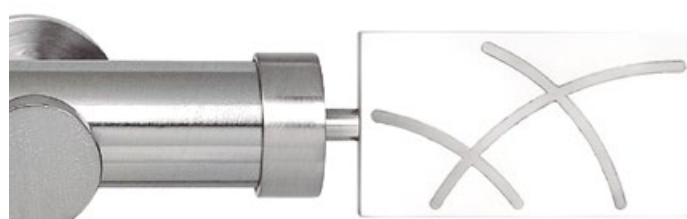

U	Ø 19 REF K.8118ABL	Ø 30 REF K.8107ABL	Ø 19/19 REF K.8119ABL	Ø 30/19 REF K.8121ABL	Q	cm
1	120,18 €	160,70 €	197,98 €	244,40 €	16	150
1	130,04 €	176,30 €	217,72 €	269,86 €	20	200
1	163,99 €	225,08 €	264,43 €	334,35 €	26	250
1	173,26 €	240,97 €	282,97 €	359,51 €	30	300
1	198,65 €	282,19 €	333,75 €	426,12 €	40	400



Cavity acero



Cavity naranja



Cavity amarillo



Cavity negro

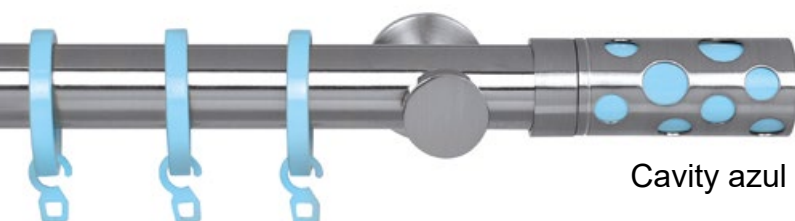

Cavity azul



Cavity rojo



Cavity blanco



Cavity verde



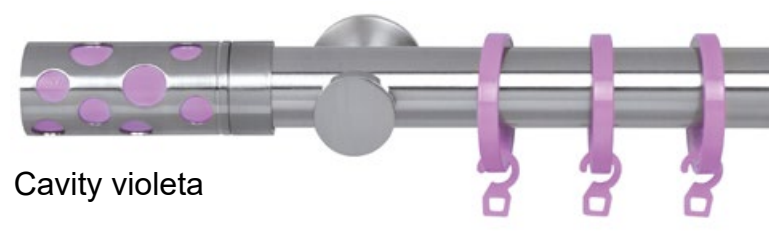

Cavity gris



Cavity violeta

 Infinity COLORS con todas sus opciones cromáticas, explota la alegría que transmiten los colores pudiendo combinar perfectamente en cualquier habitación.

 Infinity COLORS with a full choice of colours, exploits the joy that transmit the colours to match perfectly into any colour decoration room.

 Infinity COLORS avec un choix plein de couleurs, exploite la joie qui transmettent les couleurs pour correspondre parfaitement dans toutes les



Tapón acero



Tapón naranja



Tapón amarillo



Tapón negro

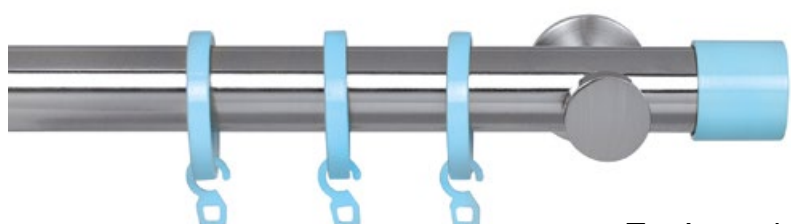

Tapón azul



Tapón rojo



Tapón Blanco



Tapón verde

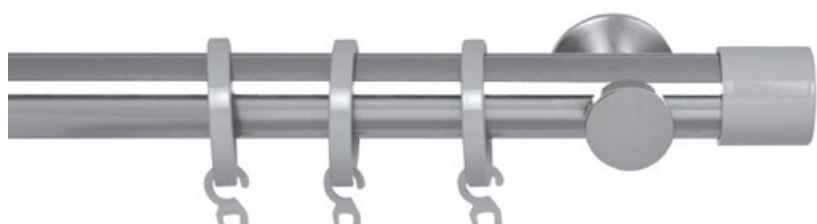

Tapón gris



Tapón violeta



Monde acero



Monde naranja



Monde amarillo



Monde negro



Monde azul



Monde rojo



Monde blanco



Monde verde

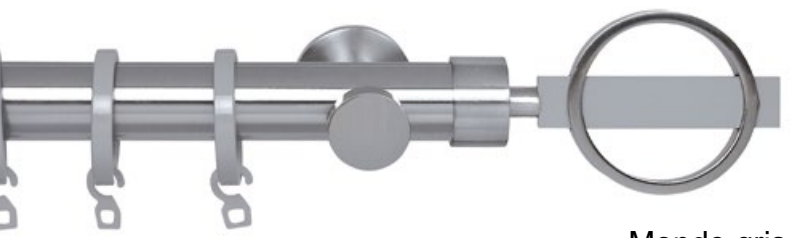

Monde gris



Monde violeta

Conjuntos completos COLORS /
Complete sets COLORS /
Kits complete COLORS



Cavity Acero



U	Ø 19 REF K.8618A	Ø 30 REF K.8607A	Ø 19/19 REF K.8619A	Ø 30/19 REF K.8621A	Q	cm
1	99,34 €	145,98 €	156,31 €	208,84 €	16	150
1	109,20 €	161,58 €	176,04 €	234,30 €	20	200
1	143,15 €	210,36 €	222,76 €	298,79 €	26	250
1	152,42 €	226,25 €	241,29 €	323,96 €	30	300
1	177,81 €	267,47 €	292,08 €	390,56 €	40	400

Tapón Acero



U	Ø 19 REF K.6318A	Ø 30 REF K.6307A	Ø 19/19 REF K.6319A	Ø 30/19 REF K.6321A	Q	cm
1	85,08 €	124,22 €	127,79 €	172,82 €	16	150
1	94,94 €	139,82 €	147,52 €	198,28 €	20	200
1	128,89 €	188,60 €	194,24 €	262,78 €	26	250
1	138,16 €	204,49 €	212,77 €	287,94 €	30	300
1	163,55 €	245,71 €	263,56 €	354,55 €	40	400

Monde Acero



U	Ø 19 REF K.8518A	Ø 30 REF K.8507A	Ø 19/19 REF K.8519A	Ø 30/19 REF K.8521A	Q	cm
1	103,43 €	149,75 €	164,50 €	216,71 €	16	150
1	113,30 €	165,35 €	184,23 €	242,17 €	20	200
1	147,25 €	214,13 €	230,94 €	306,66 €	26	250
1	156,52 €	230,02 €	249,48 €	331,82 €	30	300
1	181,91 €	271,24 €	300,27 €	398,43 €	40	400

Cavity Colores

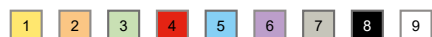

U	Ø 19 REF K.8618	Ø 30 REF K.8607	Ø 19/19 REF K.8619	Ø 30/19 REF K.8621	Q	cm
1	101,04 €	141,11 €	159,71 €	205,67 €	16	150
1	112,15 €	156,84 €	181,93 €	232,51 €	20	200
1	146,33 €	203,11 €	229,10 €	294,72 €	26	250
1	156,84 €	219,14 €	250,13 €	321,26 €	30	300
1	183,70 €	257,99 €	303,85 €	386,98 €	40	400

Tapón Colores



U	Ø 19 REF K.6318	Ø 30 REF K.6307	Ø 19/19 REF K.6319	Ø 30/19 REF K.6321	Q	cm
1	82,18 €	116,40 €	121,99 €	162,10 €	16	150
1	93,29 €	132,14 €	144,21 €	188,95 €	20	200
1	127,47 €	178,41 €	191,38 €	251,16 €	26	250
1	137,98 €	194,44 €	212,41 €	277,70 €	30	300
1	164,84 €	233,29 €	266,13 €	343,41 €	40	400

Monde Colores

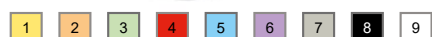
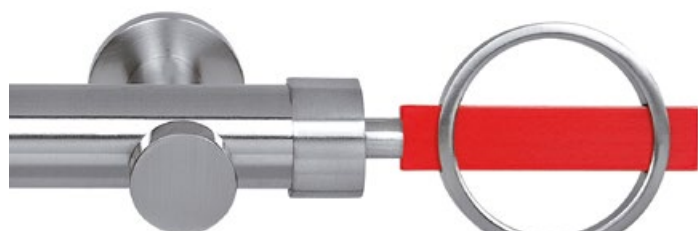

U	Ø 19 REF K.8518	Ø 30 REF K.8507	Ø 19/19 REF K.8519	Ø 30/19 REF K.8521	Q	cm
1	105,13 €	144,88 €	167,90 €	213,53 €	16	150
1	116,24 €	160,61 €	190,12 €	240,37 €	20	200
1	150,42 €	206,89 €	237,29 €	302,59 €	26	250
1	160,93 €	222,92 €	258,31 €	329,13 €	30	300
1	187,80 €	261,76 €	312,04 €	394,84 €	40	400



Vector triangular color Acero



Vector triangular Amarillo



Vector triangular Azul



Vector triangular Blanco

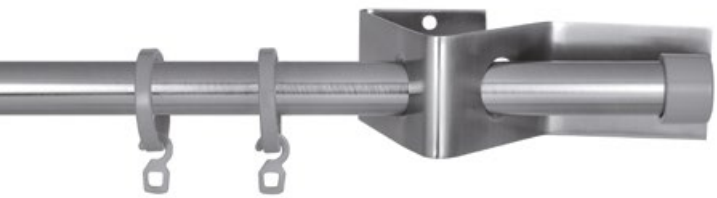

Vector triangular Gris



Vector cuadrado Naranja



Vector cuadrado Negro



Vector cuadrado Rojo



Vector cuadrado Verde



Vector cuadrado Violeta

 Lo más innovador de esta colección reside en el soporte, cuya sofisticación introduce nuevos conceptos y estilos en el mercado. Sin duda una colección original que se complementa con la barra y el soporte en color acero y 10 acabados en diferentes colores, con complementos a juego, para dar múltiples opciones y decorar ambientes con un toque de color.

 The most innovative aspect of this collection is its support, whose sophistication introduces new concepts and styles for decoration. Definitely an original collection that complements itself with the steel finish support, poles and 10 different colours with matching accessories to give multiple options for room decoration with a touch of colour.

 L'aspect le plus novateur de cette collection réside dans les supports, que introduisent sophistication, de nouveaux concepts et de styles pour la décoration. Certainement une collection originale qui se complète avec la barre et les supports de finition en acier, et 10 couleurs différentes avec les accessoires assortis pour donner de multiples options pour la décoration de la chambre avec une touche de couleur.

Conjuntos completos VECTOR /
Complete sets VECTOR /
Kits complete VECTOR



Triangular Acero



U	Ø 19 REF K.8818A	Ø 30 REF K.8807A			Q	cm
1	63,23 €	92,44 €			16	150
1	73,09 €	108,03 €			20	200
1	125,30 €	176,46 €			26	250
1	140,92 €	192,35 €			30	300
1	159,97 €	233,57 €			40	400

Triangular Colores



U	Ø 19 REF K.8818	Ø 30 REF K.8807			Q	cm
1	60,33 €	84,62 €			16	150
1	71,44 €	100,35 €			20	200
1	123,88 €	166,27 €			26	250
1	140,74 €	182,30 €			30	300
1	161,25 €	221,15 €			40	400

Cuadrado Acero





U	Ø 19 REF K.8918A	Ø 30 REF K.8907A			Q	cm
1	63,23 €	92,44 €			16	150
1	73,09 €	108,03 €			20	200
1	125,30 €	176,46 €			26	250
1	140,92 €	192,35 €			30	300
1	159,97 €	233,57 €			40	400

Cuadrado Colores

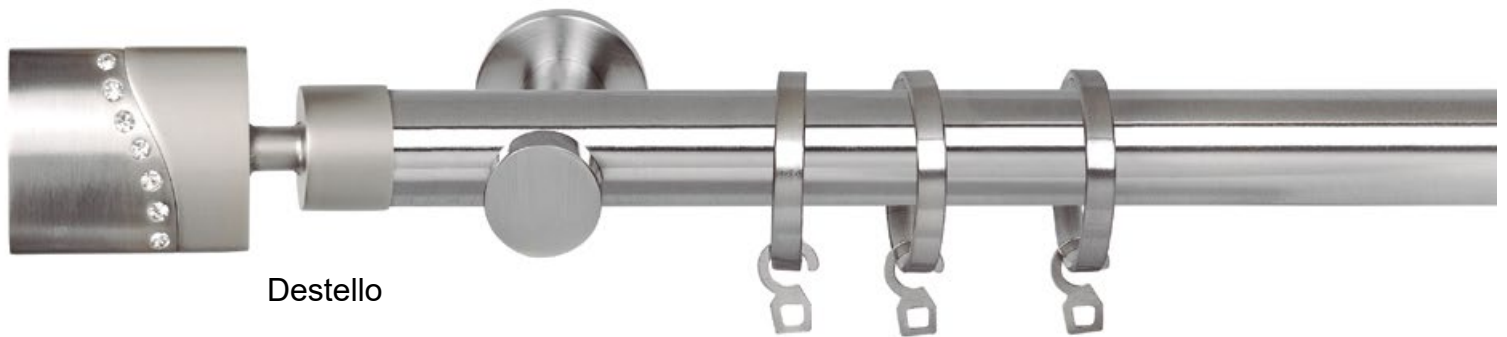
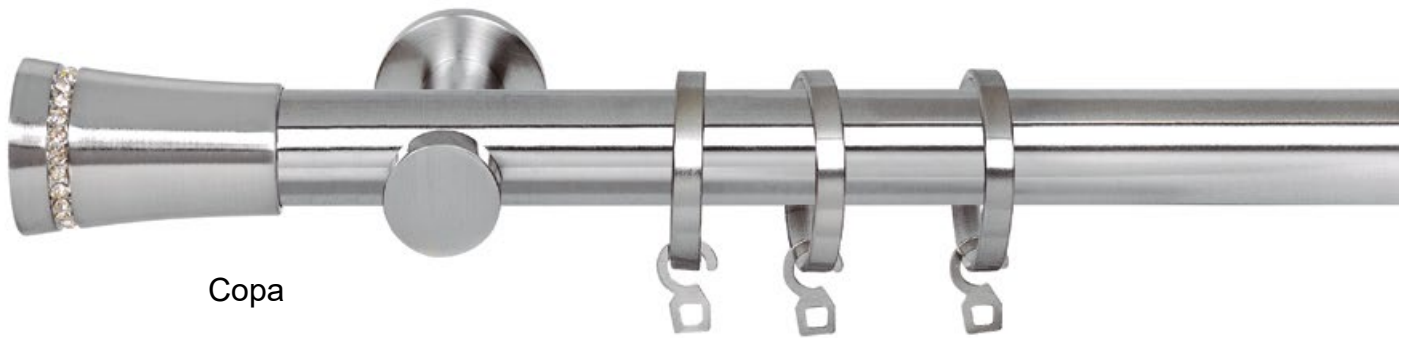
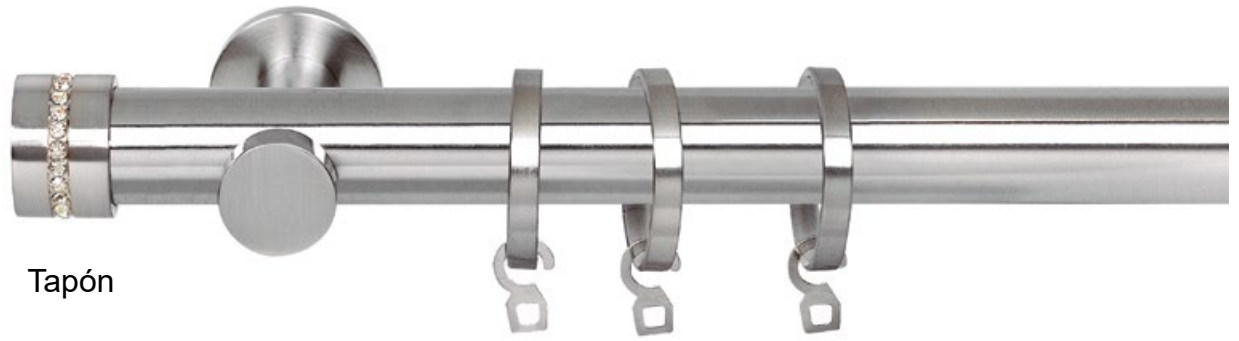

U	Ø 19 REF K.8918	Ø 30 REF K.8907			Q	cm
1	60,33 €	84,62 €			16	150
1	71,44 €	100,35 €			20	200
1	123,88 €	166,27 €			26	250
1	140,74 €	182,30 €			30	300
1	161,25 €	221,15 €			40	400



 Infinity CRISTAL se apodera del estilismo y la pureza de un material noble como el cristal para dar un aire moderno y puro a cualquier estancia.

 Infinity CRISTAL seizes the styling and the purity of a noble material like glass to give a modern and pure air to any room.

 Infinity CRISTAL mélange le style et la pureté d'un matériau noble comme le verre pour donner un air moderne et pur à chaque décoration.

* Empaquetado en blister / Supplier in blister / Emballé en blister

Ø 19 / 30 mm

Conjuntos completos CRISTAL /
Complete sets CRISTAL /
Kits complete CRISTAL

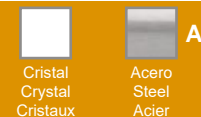

Tapón



U	Ø 19 REF K.5118A	Ø 30 REF K.5107A	Ø 19/19 REF K.5119A	Ø 30/19 REF K.5121A	Q	cm
1	92,62 €	136,00 €	142,88 €	192,14 €	16	150
1	102,49 €	151,59 €	162,61 €	217,60 €	20	200
1	136,44 €	200,38 €	209,32 €	282,10 €	26	250
1	145,71 €	216,27 €	227,86 €	307,26 €	30	300
1	171,10 €	257,49 €	278,65 €	373,87 €	40	400

Cilindro



U	Ø 19 REF K.5218A	Ø 30 REF K.5207A	Ø 19/19 REF K.5219A	Ø 30/19 REF K.5221A	Q	cm
1	106,05 €	149,71 €	169,74 €	219,28 €	16	150
1	115,92 €	165,30 €	189,47 €	244,74 €	20	200
1	149,87 €	214,08 €	236,19 €	309,24 €	26	250
1	159,14 €	229,98 €	254,73 €	334,40 €	30	300
1	184,53 €	271,19 €	305,51 €	401,01 €	40	400

Copa



U	Ø 19 REF K.5318A	Ø 30 REF K.5307A	Ø 19/19 REF K.5319A	Ø 30/19 REF K.5321A	Q	cm
1	99,75 €	145,29 €	157,14 €	208,56 €	16	150
1	109,62 €	160,89 €	176,87 €	234,03 €	20	200
1	143,57 €	209,67 €	223,58 €	298,52 €	26	250
1	152,84 €	225,56 €	242,12 €	323,68 €	30	300
1	178,23 €	266,78 €	292,91 €	390,29 €	40	400

Destello



U	Ø 19 REF K.5418A	Ø 30 REF K.5407A	Ø 19/19 REF K.5419A	Ø 30/19 REF K.5421A	Q	cm
1	97,41 €	139,77 €	152,44 €	200,70 €	16	150
1	107,27 €	155,37 €	172,18 €	226,16 €	20	200
1	141,22 €	204,15 €	218,89 €	290,65 €	26	250
1	150,49 €	220,04 €	237,43 €	315,81 €	30	300
1	175,88 €	261,26 €	288,21 €	382,42 €	40	400

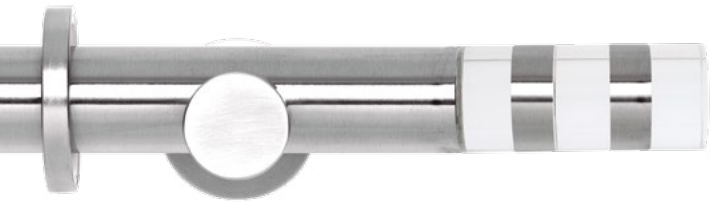

(*) (**) Lyra



Astra (*)

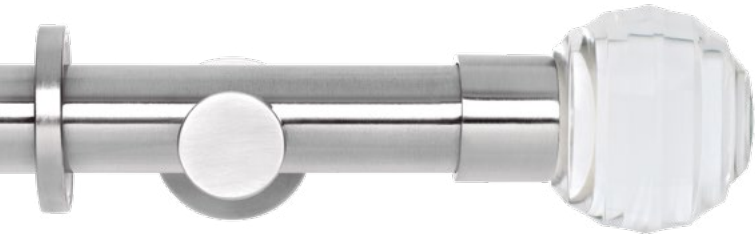

(*) Indus

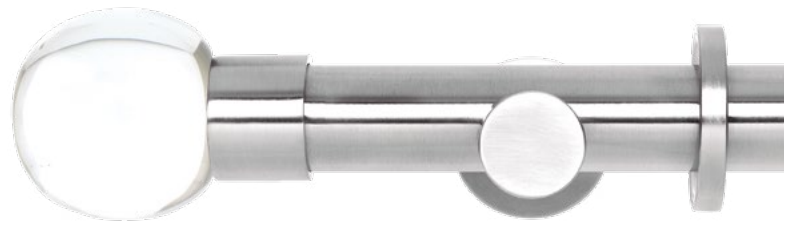

Oslo (*)



(*) Custom



Ejemplo Custom /
Example Custom / Exemple Custom





Ejemplo Custom /
Example Custom / Exemple Custom



Ejemplo Custom /
Example Custom / Exemple Custom

 Infinity ICE permite customizar algunos de sus elementos de una forma que ninguna otra colección permite gracias al uso de recipientes transparentes de metacrilato.

 Infinity ICE allows customize some elements in a way that no other collection through the use of transparent acrylic finials.

 Infinity ICE permet de personnaliser certains éléments d'une manière qu'aucun autre collection grâce à l'utilisation des embouts acryliques transparents.

* Empaquetado en blister / Supplier in blister / Emballé en blister

Conjuntos completos ICE /
Complete sets ICE /
Kits complete ICE

Metacrilato
Methacrylate
Methacrylate

Acero
Steel
Acier

Lyra



U	Ø 19 REF K.17118A	Ø 30 REF K.17107A	Ø 19/19 REF K.17119A	Ø 30/19 REF K.17121A	Q	cm
1	113,69 €	162,22 €	185,01 €	239,43 €	16	150
1	123,56 €	177,81 €	204,75 €	264,89 €	20	200
1	157,50 €	226,60 €	251,46 €	329,38 €	26	250
1	166,77 €	242,49 €	270,00 €	354,55 €	30	300

Astra



U	Ø 19 REF K.17218A	Ø 30 REF K.17207A	Ø 19/19 REF K.17219A	Ø 30/19 REF K.17221A	Q	cm
1	114,10 €	168,15 €	185,84 €	245,78 €	16	150
1	123,97 €	183,75 €	205,57 €	271,24 €	20	200
1	157,92 €	232,53 €	252,29 €	335,73 €	26	250
1	167,19 €	248,42 €	270,83 €	360,89 €	30	300

Indus



U	Ø 19 REF K.17318A	Ø 30 REF K.17307A	Ø 19/19 REF K.17319A	Ø 30/19 REF K.17321A	Q	cm
1	116,77 €	167,56 €	191,18 €	247,85 €	16	150
1	126,64 €	183,15 €	210,91 €	273,31 €	20	200
1	160,59 €	231,93 €	257,62 €	337,80 €	26	250
1	169,86 €	247,83 €	276,16 €	362,96 €	30	300

Oslo



U	Ø 19 REF K.17418A	Ø 30 REF K.17407A	Ø 19/19 REF K.17419A	Ø 30/19 REF K.17421A	Q	cm
1	119,58 €	166,36 €	196,79 €	249,46 €	16	150
1	129,44 €	181,95 €	216,52 €	274,92 €	20	200
1	163,39 €	230,74 €	263,24 €	339,41 €	26	250
1	172,66 €	246,63 €	281,77 €	364,57 €	30	300

Custom



U		Ø 30 REF K.17507A			Q	cm
1		146,35 €			16	150
1		161,94 €			20	200
1		210,73 €			26	250
1		226,62 €			30	300

Metacrilato ■
Methacrylate
Methacrylate

Acero ■
Steel
Acier



Aurora negro



Aurora negro



Aurora blanco



Aurora blanco



Boreal negro



Boreal negro



Boreal blanco



Boreal blanco



Austral



Austral

Infinity POLAR es una colección realmente atractiva que permite personalizar la barra en acero o en metacrilato.

Infinity POLAR is a really attractive collection that allows you to customize the decoration using the steel or acrylic poles.

Infinity POLAR est une collection vraiment intéressante qui vous permet de personnaliser la décoration en utilisant les barres d'acier ou acryliques.

Conjuntos completos POLAR Acero /
Complete sets POLAR Acero /
Kits complete POLAR Acero

MN **MB** **A**
Negro Black Noir Blanco White Blanc Acero Steel Acier

Aurora



U	Ø 30 REF K.12107	Ø 30/19 REF K.12121	cm
1	153,34 €	219,19 € *	16 150
1	168,94 €	227,40 € *	20 200
1	217,72 €	291,89 € *	26 250
1	233,61 €	317,06 € *	30 300

Boreal



U	Ø 30 REF K.12207	Ø 30/19 REF K.12221	cm
1	155,83 €	204,42 € *	16 150
1	171,42 €	229,89 € *	20 200
1	220,20 €	294,38 € *	26 250
1	236,10 €	319,54 € *	30 300

Austral



U	Ø 30 REF K.12307T	Ø 30/19 REF K.12321T	cm
1	142,39 €	190,99 € *	16 150
1	157,99 €	216,45 € *	20 200
1	206,77 €	280,95 € *	26 250
1	222,66 €	306,11 € *	30 300

(*) Conjunto dobles POLAR Acero:
La Barra 19mm se sirve con piña tapón.

(*) Double sets POLAR Acero:
Pole of 19 mm with finial endcap.

(*) Kits doubles POLAR Acero:
Barre de 19 mm avec embout bouchon.

Conjuntos completos POLAR Metacrilato /
Complete sets POLAR Methacrylate /
Kits complete POLAR Methacrylate

MN **MB** **M**
Negro Black Noir Blanco White Blanc Metacrilato Methacrylate Methacrylate

Aurora



U	Ø 30 REF K.11807BL	cm
1	209,83 €	16 150
1	238,19 €	20 200
1	276,64 €	26 250
1	292,51 €	30 300

Boreal



U	Ø 30 REF K.11907BL	cm
1	212,31 €	16 150
1	240,67 €	20 200
1	279,13 €	26 250
1	295,00 €	30 300

Austral



U	Ø 30 REF K.12007T	cm
1	199,96 €	16 150
1	228,74 €	20 200
1	265,72 €	26 250
1	283,71 €	30 300

Barra de Cortina INFINITY VANITY / Curtain Pole INFINITY VANITY / Tringle a Rideux INFINITY VANITY

- Diseñado con cristales originales de Swarovski ® por Altran Solutions SL
 Designed with original crystals from Swarovski ® by Altran Solutions SL
 Conçue avec cristaux originaux Swarovski ® par Altran Solutions SL



Aura



Orbe



Estela

🇪🇸 Altran ha diseñado su colección de acero inoxidable Infinity Vanity empleando exclusivos crystals from Swarovski ®. Pocos complementos tan lujosos y elegantes como el cristal tallado se ven en el mercado de las barras de cortina y mucho menos si ese cristal cuenta con el aval y el esmero con el que Swarovski® trabaja cada una de sus piezas. Disfrute de un mundo privilegiado con esta colección.

🇬🇧 Altran has designed his collection of stainless steel Infinity Vanity using exclusive crystals from Swarovski ®. Very few so luxurious and elegant complements like the carved crystal are seen on the market of the curtain poles and much less if this crystal relies on the support and the credentials of every single Swarovski® piece. Enjoy a privileged world with this collection.

🇫🇷 Altran a conçu la collection d'acier inoxydable Infinity Vanity en utilisant des crystals from Swarovski ®. Très peu de compléments si luxueux et élégants comme le cristal sculpté sont disponibles sur le marché des tringles à rideaux et beaucoup moins si ce cristal repose sur le soutien et l'accréditation de chaque pièce unique Swarovski®. Profitez d'un monde privilégié avec cette collection.

Conjuntos completos VANITY Cristales de Swarovski® /
 Complete sets VANITY Crystals from Swarovski® /
 Kits complete VANITY Cristaux Swarovski®

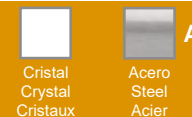

Aura



U	Ø 19 REF K.14618A	Ø 30 REF K.14607A	Ø 19/19 REF K.14619A	Ø 30/19 REF K.14621A	Q	cm
1	158,24 €	218,53 €	274,12 €	340,29 €	16	150
1	168,11 €	234,12 €	293,85 €	365,75 €	20	200
1	202,06 €	282,91 €	340,56 €	430,25 €	26	250
1	211,33 €	298,80 €	359,10 €	455,41 €	30	300

Orbe



U	Ø 19 REF K.14818A	Ø 30 REF K.14807A	Ø 19/19 REF K.14819A	Ø 30/19 REF K.14821A	Q	cm
1	191,16 €	409,21 €	339,96 €	563,89 €	16	150
1	201,03 €	424,80 €	359,69 €	589,35 €	20	200
1	234,98 €	473,59 €	406,40 €	653,85 €	26	250
1	244,25 €	489,48 €	424,94 €	679,01 €	30	300

Estela

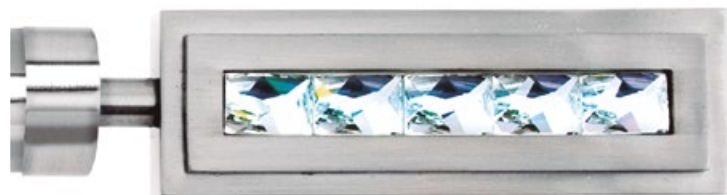

U	Ø 19 REF K.14918A	Ø 30 REF K.14907A	Ø 19/19 REF K.14919A	Ø 30/19 REF K.14921A	Q	cm
1	176,48 €	230,89 €	310,60 €	370,89 €	16	150
1	186,35 €	246,48 €	330,33 €	396,35 €	20	200
1	220,30 €	295,27 €	377,04 €	460,85 €	26	250
1	229,57 €	311,16 €	395,58 €	486,01 €	30	300

Certificado de Calidad Disponible.
 Certificate of Quality Available.
 Certificat de Qualité Disponible.

Estos terminales de cortina brillan por encima de todo porque están creados con Crystals from Swarovski®.

This finials have a special unique GLOW since they are developed with Crystals from Swarovski®.

Ces embouts ont un éclat brillant unique parce qu'ils ont été développés avec Crystals from Swarovski®.



(*) Multipiña



(*) Calada



(*) Cenefa



(*) Metro



(*) Tapón



(*) Creta acero

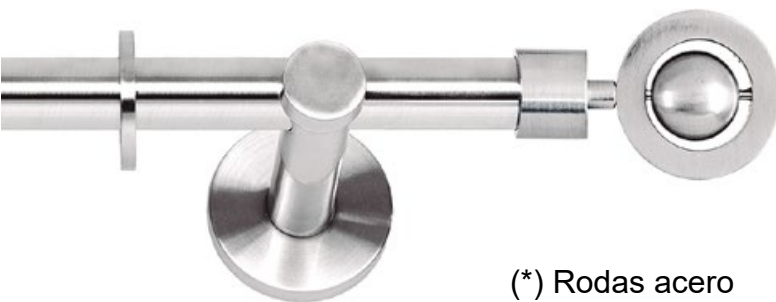



(*) Rodas acero



(*) Media Bola

 Infinity BASIC abarca un mercado más sencillo ofreciendo una opción muy económica pero rica en una estética moderna gracias a sus perfectos acabados en acero.

 Infinity BASIC aims to provide solutions for those decorations where its needed an economical option but with a modern design with its perfect steel finish.

 Infinity BASIC offre des solutions pour les décorations où il y a besoin d'une option économique mais avec un design moderne avec sa finition en acier.

* Empaquetado en blister / Supplier in blister / Emballé en blister

Conjuntos completos **BASIC** /
Complete sets **BASIC** /
Kits complete **BASIC**

A
Acero
Steel
Acier

Multipiña



U	Ø 19 REF K.6018A	Ø 30 REF K.6007A	Ø 19/19 REF K.6019A	Ø 30/19 REF K.6021A	Q	cm
1	91,89 €	141,38 €	141,40 €	196,79 €	16	150
1	101,75 €	156,98 €	161,14 €	222,25 €	20	200
1	135,70 €	205,76 €	207,85 €	286,74 €	26	250
1	144,97 €	221,65 €	226,39 €	311,90 €	30	300
1	170,36 €	262,87 €	277,17 €	378,51 €	40	400

Calada



U	Ø 19 REF K.6118A	Ø 30 REF K.6107A	Ø 19/19 REF K.6119A	Ø 30/19 REF K.6121A	Q	cm
1	90,18 €	138,81 €	138,00 €	192,51 €	16	150
1	100,05 €	154,40 €	157,73 €	217,97 €	20	200
1	134,00 €	203,18 €	204,45 €	282,46 €	26	250
1	143,27 €	219,08 €	251,41 €	307,63 €	30	300
1	182,87 €	260,29 €	302,20 €	374,23 €	40	400

Cenefa



U	Ø 19 REF K.6218A	Ø 30 REF K.6207A	Ø 19/19 REF K.6219A	Ø 30/19 REF K.6221A	Q	cm
1	89,82 €	140,51 €	137,26 €	193,84 €	16	150
1	99,68 €	156,10 €	157,00 €	219,31 €	20	200
1	133,63 €	204,88 €	203,71 €	283,80 €	26	250
1	142,90 €	220,78 €	222,25 €	308,96 €	30	300
1	168,29 €	261,99 €	273,03 €	375,57 €	40	400

Metro



U	Ø 19 REF K.8018A	Ø 30 REF K.8007A	Ø 19/19 REF K.8019A	Ø 30/19 REF K.8021A	Q	cm
1	93,36 €	135,72 €	144,35 €	192,60 €	16	150
1	103,22 €	151,32 €	164,08 €	218,06 €	20	200
1	137,17 €	200,10 €	210,80 €	282,56 €	26	250
1	146,44 €	215,99 €	229,33 €	307,72 €	30	300
1	171,83 €	257,21 €	280,12 €	374,33 €	40	400

Conjuntos completos BASIC /
Complete sets BASIC /
Kits complete BASIC



Tapón



U	Ø 19 REF K.6318A	Ø 30 REF K.6307A	Ø 19/19 REF K.6319A	Ø 30/19 REF K.6321A		cm
1	85,08 €	124,22 €	127,79 €	172,82 €	16	150
1	94,94 €	139,82 €	147,52 €	198,28 €	20	200
1	128,89 €	188,60 €	194,24 €	262,78 €	26	250
1	138,16 €	204,49 €	212,77 €	287,94 €	30	300
1	163,55 €	245,71 €	263,56 €	354,55 €	40	400

Creta

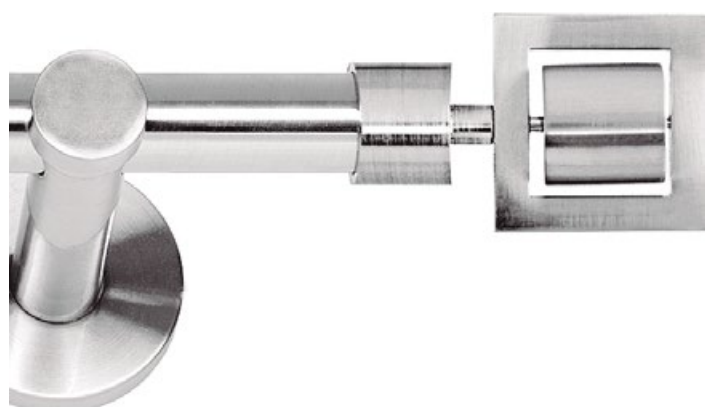

U	Ø 19 REF K.11318A	Ø 30 REF K.11307A	Ø 19/19 REF K.11319A	Ø 30/19 REF K.11321A		cm
1	102,74 €	157,48 €	163,12 €	223,74 €	16	150
1	112,61 €	173,08 €	182,85 €	249,21 €	20	200
1	171,93 €	221,86 €	229,56 €	313,70 €	26	250
1	155,83 €	237,75 €	248,10 €	338,86 €	30	300
1	181,22 €	239,91 €	298,89 €	405,47 €	40	400

Rodas



U	Ø 19 REF K.11518A	Ø 30 REF K.11507A	Ø 19/19 REF K.11519A	Ø 30/19 REF K.11521A		cm
1	101,36 €	156,19 €	145,06 €	221,08 €	16	150
1	111,23 €	171,79 €	180,09 €	246,54 €	20	200
1	145,18 €	220,57 €	226,80 €	311,03 €	26	250
1	154,45 €	236,46 €	245,34 €	336,19 €	30	300
1	179,84 €	277,68 €	296,13 €	402,80 €	40	400

Media Bola



U	Ø 19 REF K.12418A	Ø 30 REF K.12407A	Ø 19/19 REF K.12419A	Ø 30/19 REF K.12421A		cm
1	96,16 €	158,40 €	149,96 €	218,09 €	16	150
1	106,03 €	174,00 €	169,69 €	243,55 €	20	200
1	139,98 €	222,78 €	216,41 €	308,04 €	26	250
1	149,25 €	238,67 €	234,95 €	333,20 €	30	300
1	174,64 €	279,89 €	285,73 €	399,81 €	40	400



Aqua acero



Eolo acero



Iris acero



Blasón acero y negro



Olimpo acero y negro

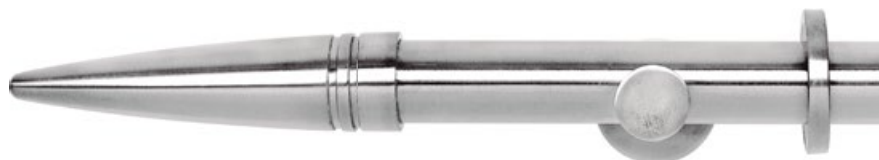

Atlas acero



Etna acero y negro



Etna acero



Vega acero y negro





Vega acero



Solaris acero

 Infinity EXCLUSIVE busca diferenciarse del resto mostrando orgullosamente un estilo propio, arriesgado y moderno.

 EXCLUSIVE Infinity seeks to differentiate itself from the rest displaying its own particular and modern style.

 Infinity EXCLUSIVE cherche à se différencier du reste avec son propre style et modernité.

Conjuntos completos EXCLUSIVE /
Complete sets EXCLUSIVE /
Kits complete EXCLUSIVE



Aqua Acero



U	Ø 19 REF K.6418A	Ø 30 REF K.6407A	Ø 19/19 REF K.6419A	Ø 30/19 REF K.6421A	cm	cm
1	117,97 €	155,23 €	193,57 €	236,72 €	16	150
1	127,83 €	170,82 €	213,30 €	262,18 €	20	200
1	161,78 €	219,60 €	260,02 €	326,67 €	26	250
1	171,05 €	235,50 €	278,55 €	351,83 €	30	300
1	196,44 €	276,71 €	329,34 €	418,44 €	40	400

Eolo Acero



U	Ø 19 REF K.6518A	Ø 30 REF K.6507A	Ø 19/19 REF K.6519A	Ø 30/19 REF K.6521A	cm	cm
1	132,78 €	168,48 €	223,19 €	264,78 €	16	150
1	142,65 €	184,07 €	242,93 €	290,24 €	20	200
1	176,59 €	232,85 €	289,64 €	354,73 €	26	250
1	185,86 €	248,75 €	308,18 €	379,89 €	30	300
1	211,26 €	289,96 €	358,96 €	446,50 €	40	400

Iris Acero



U	Ø 19 REF K.6618A	Ø 30 REF K.6607A	Ø 19/19 REF K.6619A	Ø 30/19 REF K.6621A	cm	cm
1	113,87 €	150,03 €	185,38 €	227,42 €	16	150
1	123,74 €	165,62 €	205,11 €	252,89 €	20	200
1	157,69 €	214,41 €	251,83 €	317,38 €	26	250
1	166,96 €	230,30 €	270,37 €	342,54 €	30	300
1	192,35 €	271,52 €	321,15 €	409,15 €	40	400

Blasón Acero y Negro

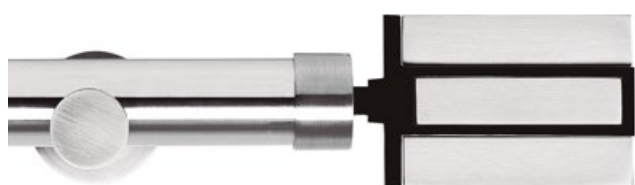

U	Ø 19 REF K.5918AB	Ø 30 REF K.5907AB	Ø 19/19 REF K.5919AB	Ø 30/19 REF K.5921AB	cm	cm
1	107,57 €	174,13 €	172,78 €	245,23 €	16	150
1	117,44 €	189,73 €	192,51 €	270,69 €	20	200
1	151,39 €	238,51 €	239,22 €	335,18 €	26	250
1	160,66 €	254,40 €	257,76 €	360,34 €	30	300
1	186,05 €	295,62 €	308,55 €	426,95 €	40	400

Olimpo Acero y Negro



U	Ø 19 REF K.5818A	Ø 30 REF K.5807A	Ø 19/19 REF K.5819A	Ø 30/19 REF K.5821A	cm	cm
1	106,38 €	157,57 €	170,38 €	227,47 €	16	150
1	116,24 €	173,17 €	190,12 €	252,93 €	20	200
1	150,19 €	221,95 €	236,83 €	317,42 €	26	250
1	159,46 €	237,84 €	255,37 €	342,59 €	30	300
1	184,85 €	279,06 €	306,15 €	409,19 €	40	400

Atlas Acero



U	Ø 19 REF K.6718A	Ø 30 REF K.6707A	Ø 19/19 REF K.6719A	Ø 30/19 REF K.6721A	cm	cm
1	99,66 €	157,39 €	156,95 €	220,57 €	16	150
1	109,53 €	172,98 €	176,69 €	246,03 €	20	200
1	143,47 €	221,77 €	223,40 €	310,52 €	26	250
1	152,74 €	237,66 €	241,94 €	335,69 €	30	300
1	178,14 €	278,88 €	292,72 €	402,29 €	40	400

Conjuntos completos **EXCLUSIVE /**
 Complete sets **EXCLUSIVE /**
 Kits complete **EXCLUSIVE**



Etna Acero



U	Ø 19 REF K.6918A	Ø 30 REF K.6907A	Ø 19/19 REF K.6919A	Ø 30/19 REF K.6921A	Q	cm
1	107,20 €	180,67 €	172,04 €	251,39 €	16	150
1	117,07 €	196,26 €	191,77 €	276,85 €	20	200
1	151,02 €	245,04 €	238,49 €	341,34 €	26	250
1	160,29 €	260,94 €	257,03 €	366,51 €	30	300
1	185,68 €	302,15 €	307,81 €	433,11 €	40	400

Etna Acero y Negro



U	Ø 19 REF K.6918AB	Ø 30 REF K.6907AB	Ø 19/19 REF K.6919AB	Ø 30/19 REF K.6921AB	Q	cm
1	105,41 €	184,94 €	168,45 €	253,87 €	16	150
1	115,28 €	200,54 €	188,19 €	279,34 €	20	200
1	149,22 €	249,32 €	234,90 €	343,83 €	26	250
1	158,49 €	265,21 €	253,44 €	368,99 €	30	300
1	183,89 €	306,43 €	304,22 €	435,60 €	40	400

Vega Acero



U	Ø 19 REF K.7018A	Ø 30 REF K.7007A	Ø 19/19 REF K.7019A	Ø 30/19 REF K.7021A	Q	cm
1	125,88 €	173,21 €	209,39 €	262,61 €	16	150
1	135,75 €	188,81 €	229,13 €	288,08 €	20	200
1	162,20 €	231,40 €	275,84 €	352,57 €	26	250
1	178,96 €	253,48 €	294,38 €	377,73 €	30	300
1	204,36 €	294,70 €	345,16 €	444,34 €	40	400

Vega Acero y Negro



U	Ø 19 REF K.7018AB	Ø 30 REF K.7007AB	Ø 19/19 REF K.7019AB	Ø 30/19 REF K.7021AB	Q	cm
1	127,49 €	193,55 €	212,61 €	284,56 €	16	150
1	137,36 €	209,14 €	232,35 €	310,02 €	20	200
1	171,30 €	251,74 €	279,06 €	374,51 €	26	250
1	180,57 €	273,82 €	297,60 €	399,67 €	30	300
1	205,97 €	315,03 €	348,38 €	466,28 €	40	400

Solaris Acero



U	Ø 19 REF K.6818A	Ø 30 REF K.6807A	Ø 19/19 REF K.6819A	Ø 30/19 REF K.6821A	Q	cm
1	116,40 €	155,00 €	190,44 €	234,92 €	16	150
1	126,27 €	170,59 €	210,17 €	260,38 €	20	200
1	160,22 €	213,19 €	256,89 €	324,88 €	26	250
1	169,49 €	235,27 €	275,43 €	350,04 €	30	300
1	194,88 €	276,48 €	326,21 €	416,65 €	40	400

Los conjuntos de medida superior a 2 m se sirven con 3 soportes.
 Los conjuntos de más de 3 metros se sirven empalmados.

Conjuntos Sencillos: 2 terminales, 2 soportes, barra y anillas de acero.

Conjuntos Dobles*: 4 term., 2 sop.dobles, 2 barras y anillas.

Conjunto dobles: Se sirven con el mismo terminal para ambas barras, excepto en la colección Infinity Polar, que se sirve con el terminal TAPÓN para la barra de Ø19.

All sets with a length longer than 2 meters are supplied with 3 brackets.

Sets of more than 3 mts. are supplied in 2 halves and splice.

Single sets: 2 finials, 2 brackets, pole & steel rings.

Double sets*: 4 finials, 2 double brackets, 2 poles & steel rings.

Double sets: The Double Sets are supplied with the same finials in both poles except for the collection POLAR which is supplied with the finials "Tapón" for the pole of Ø 19 .

Tous les kits de mesures supérieures à 2 mètres contiennent 3 supports.

Les sets de plus de 3 mts. sont fournis en 2 morceaux avec raccord.

Kits Simples: 2 embouts, 2 supports, tube et anneaux acier.

Kits Doubles*: 4 embouts, 2 supports doubles, 2 tubes et anneaux acier.

Kits doubles: Sont fournis avec les mêmes embouts pour les deux tringles avec l'exception de la collection POLAR qui est fourni avec des embouts "Tapón" pour les deux tringles.

Expositores INFINITY / INFINITY Displays / Presentoirs INIFNITY

Expositor
Infinity ICE

Infinity ICE
Display Board /
Presentoir
Infinity ICE



REF	∅	U	€	€	cm
M.202		1		100,84 €	

Expositor
Infinity BASIC

Infinity BASIC
Display Board /
Presentoir
Infinity BASIC



REF	∅	U	€	€	cm
M.203		1		58,82 €	

Expositor
Infinity EXCLUSIVE

Infinity EXCLUSIVE
Display Board /
Presentoir
Infinity EXCLUSIVE



REF	∅	U	€	€	cm
M.204		1		90,34 €	

Expositor
Infinity VANITY
cristales originales de
Swarovski ®

Infinity VANITY
Display Board /
Presentoir
Infinity VANITY



REF	∅	U	€	€	cm
M.205		1		317,28 €	

Expositor
Infinity COLORS

Infinity COLORS
Display Board /
Presentoir
Infinity COLORS



REF	∅	U	€	€	cm
M.211		1		45,52 €	

Expositores INFINITY / INFINITY Displays / Presentoirs INIFNITY

Expositor
Infinity ZEN

Infinity ZEN
Display Board /
Presentoir
Infinity ZEN



REF	∅	U	€	€	cm
M.212		1		90,34 €	

Expositor
Infinity CRISTAL

Infinity CRISTAL
Display Board /
Presentoir
Infinity CRISTAL



REF	∅	U	€	€	cm
M.213		1		67,24 €	

Expositor
Infinity POLAR

Infinity POLAR
Display Board /
Presentoir
Infinity POLAR



REF	∅	U	€	€	cm
M.3006		1		70,14 €	

Terminales / Finials / Embouts ZEN



Trazos

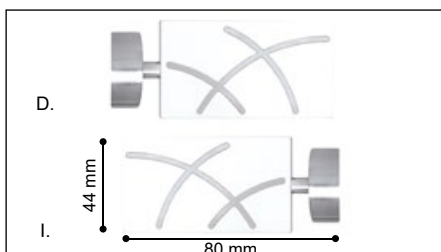

REF	∅	U	€	€	cm
P.2119ABLD	19	10	18,98 €	21,83 €	
P.2119ABLI	19	10	18,98 €	21,83 €	
P.2130ABLD	30	10	21,64 €	24,89 €	
P.2130ABLI	30	10	21,64 €	24,89 €	

Ángulo Blanco

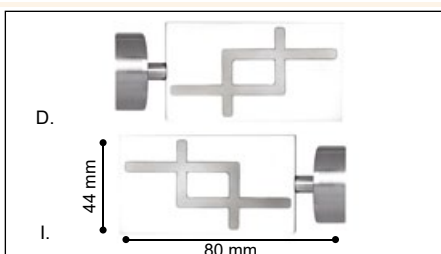

REF	∅	U	€	€	cm
P.2219ABLD	19	10	18,98 €	21,83 €	
P.2219ABLI	19	10	18,98 €	21,83 €	
P.2230ABLD	30	10	21,64 €	24,89 €	
P.2230ABLI	30	10	21,64 €	24,89 €	

Ángulo Negro

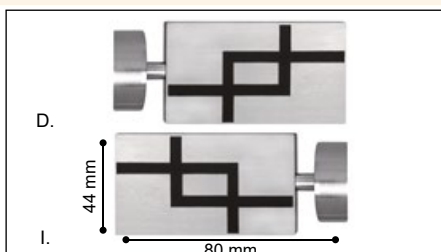

REF	∅	U	€	€	cm
P.2319ABLD	19	10	18,98 €	21,83 €	
P.2319ABLI	19	10	18,98 €	21,83 €	
P.2330ABLD	30	10	21,64 €	24,89 €	
P.2330ABLI	30	10	21,64 €	24,89 €	

Olas

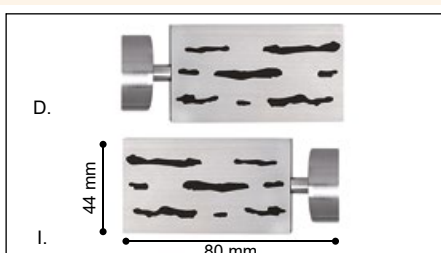

REF	∅	U	€	€	cm
P.2419ABLD	19	10	19,92 €	22,91 €	
P.2419ABLI	19	10	19,92 €	22,91 €	
P.2430ABLD	30	10	22,56 €	25,94 €	
P.2430ABLI	30	10	22,56 €	25,94 €	

Terminales / Finials / Embouts **COLORS**



Cavity Acero

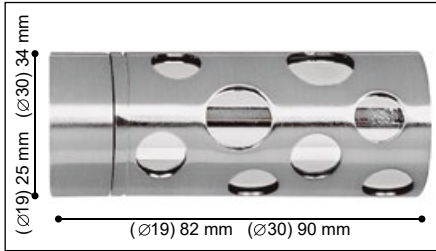

REF	∅	U	€	€ ¹	cm
P.02019A	19	10	9,92 €	11,41 €	
P.02030A	30	10	15,24 €	17,53 €	

A

Cavity Colors

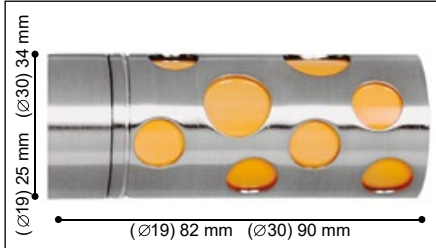

REF	∅	U	€	€ ¹	cm
P.02019	19	10	9,92 €	11,41 €	
P.02030	30	10	15,24 €	17,53 €	



Tapón Acero

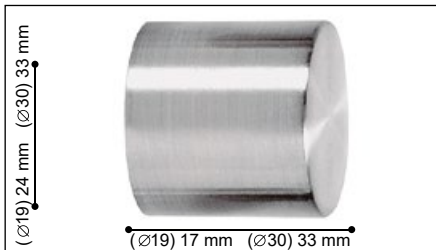

REF	∅	U	€	€ ¹	cm
S.6119A1	19	10	3,72 €	4,28 €	
S.6130A1	30	10	5,78 €	6,65 €	

A

Tapón Colors

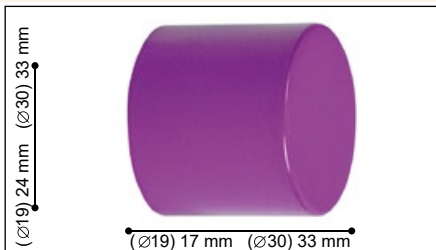

REF	∅	U	€	€ ¹	cm
A.6119	19	10	1,72 €	1,98 €	
A.6130	30	10	4,50 €	5,18 €	

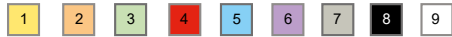

Monde Acero

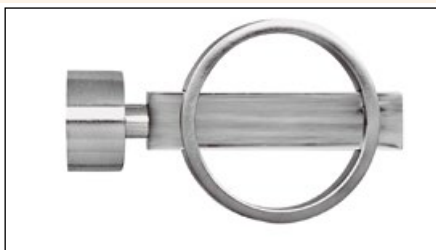

REF	∅	U	€	€ ¹	cm
P.02119A	19	10	11,70 €	13,46 €	
P.02130A	30	10	16,88 €	19,41 €	

A

Monde Colors

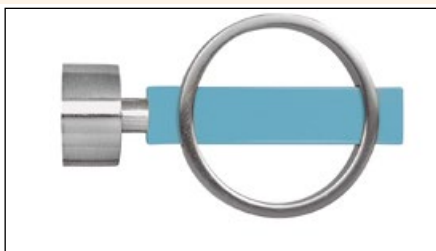

REF	∅	U	€	€ ¹	cm
P.02119	19	10	11,70 €	13,46 €	
P.02130	30	10	16,88 €	19,41 €	



Terminales / Finials / Embouts **CRISTAL**



Tapón



REF	∅	U	€	€ ¹	cm
S.6719A1	19	10	7,00 €	8,05 €	
S.6730A1	30	10	10,90 €	12,54 €	

Terminales / Finials / Embouts CRISTAL



Copa

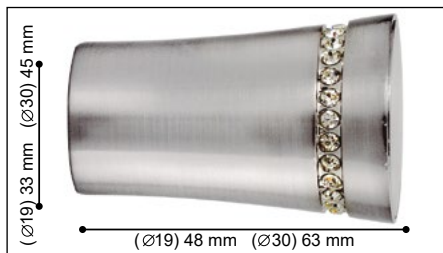

REF	∅	U	€	€	cm
S.6819A1	19	10	10,10 €	11,62 €	
S.6830A1	30	10	14,94 €	17,18 €	

Cilindro



REF	∅	U	€	€	cm
S.6919A1	19	10	12,84 €	14,77 €	
S.6930A1	30	10	16,86 €	19,39 €	

Destello

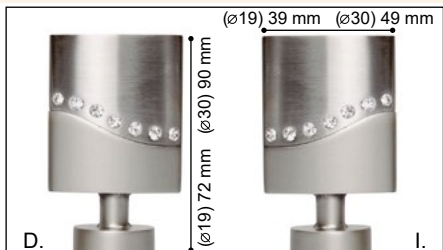

REF	∅	U	€	€	cm
S.6519AD1	19	10	9,08 €	10,44 €	
S.6519AI1	19	10	9,08 €	10,44 €	
S.6530AD1**	30	10	12,54 €	14,42 €	
S.6530AI1**	30	10	12,54 €	14,42 €	

** Terminal de 30 mm disponible hasta finalizar existencias / 30mm finial, on sale until end of stock. / 30mm embout disponible dans la limite des stocks.

Terminales / Finials / Embouts ICE

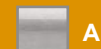

Astra

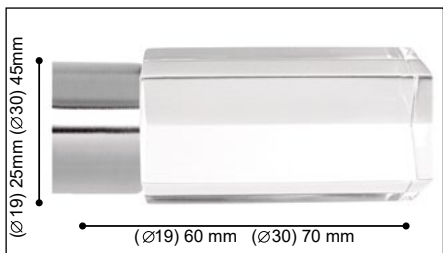

REF	∅	U	€	€	cm
S.3619A1	19	6	16,34 €	18,79 €	
S.3630A1	30	6	24,88 €	28,61 €	

Lyra

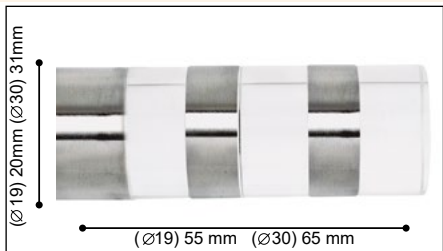

REF	∅	U	€	€	cm
S.3719A1	19	6	16,16 €	18,58 €	
S.3730A1	30	6	22,30 €	25,65 €	

** Disponible hasta finalizar existencias / On sale until end of stock. / Disponible dans la limite des stocks

Oslo

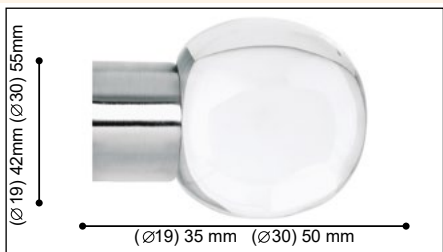

REF	∅	U	€	€	cm
S.3819A1	19	6	18,72 €	21,53 €	
S.3830A1	30	6	24,10 €	27,72 €	

Indus



REF	∅	U	€	€	cm
S.3919A1	19	6	17,50 €	20,13 €	
S.3930A1	30	6	24,62 €	28,31 €	

Terminales / Finales / Embouts ICE

Custom

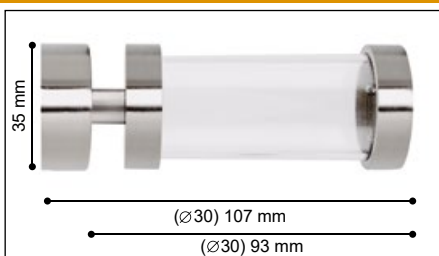

REF	∅	U	€	€	cm
S.9930A1	30	6	15,40 €	17,71 €	

Terminales / Finales / Embouts POLAR

MN MB M

Aurora

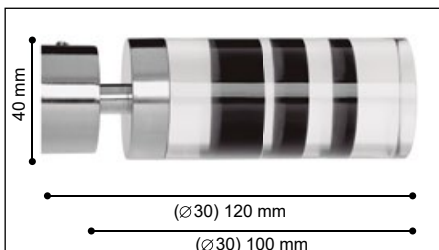

REF	∅	U	€	€	cm
S.8630MB1	30	10	18,44 €	21,21 €	
S.8630MN1	30	10	18,44 €	21,21 €	

Boreal

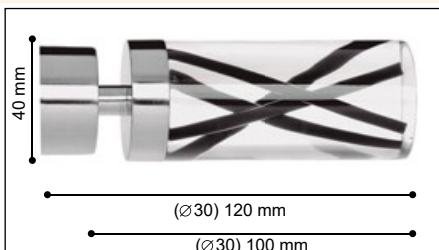

REF	∅	U	€	€	cm
S.8730MB1	30	10	19,52 €	22,45 €	
S.8730MN1	30	10	19,52 €	22,45 €	

Austral

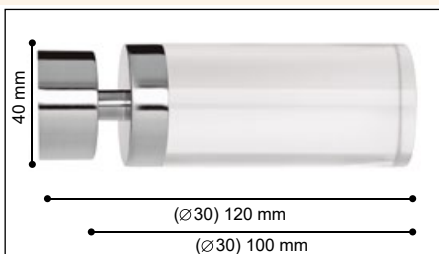

REF	∅	U	€	€	cm
S.8830M1	30	10	13,68 €	15,73 €	

Terminales / Finales / Embouts VANITY crystals from Swarovski®

A

Aura Altran con Cristales Swarovski®

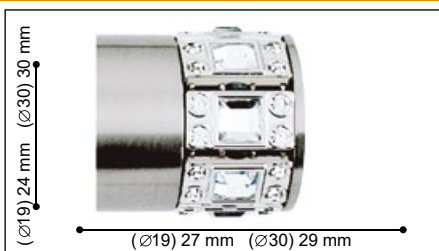

REF	∅	U	€	€	cm
P.9519A	19	1		40,86 €	
P.9530A	30	1		53,80 €	

Orbe Altran con Cristales Swarovski®

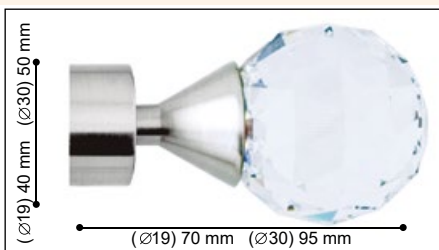

REF	∅	U	€	€	cm
P.9719A	19	1		57,32 €	
P.9730A	30	1		149,14 €	

Estela Altran con Cristales Swarovski®



REF	∅	U	€	€	cm
P.9819A	19	1		49,98 €	
P.9830A	30	1		59,98 €	

Multipiña

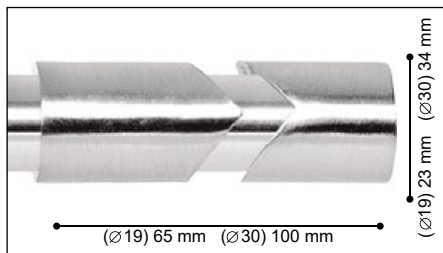

REF	Ø	U	€	€	cm
S.6419A1	19	10	6,68 €	7,68 €	
S.6430A1	30	10	13,24 €	15,23 €	

Calada

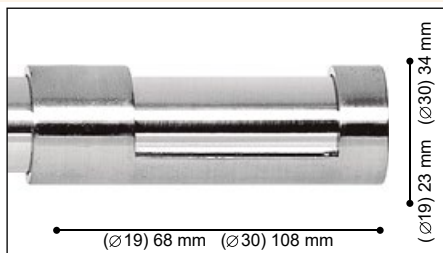

REF	Ø	U	€	€	cm
S.6219A1	19	10	5,94 €	6,83 €	
S.6230A1	30	10	12,12 €	13,94 €	

Cenefa

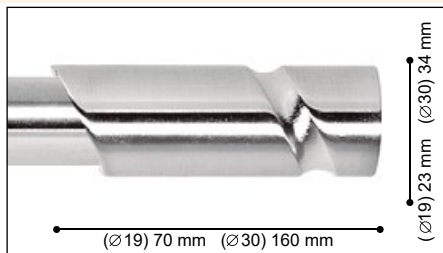

REF	Ø	U	€	€	cm
S.6319A1	19	10	5,78 €	6,65 €	
S.6330A1	30	10	12,86 €	14,79 €	

Metro

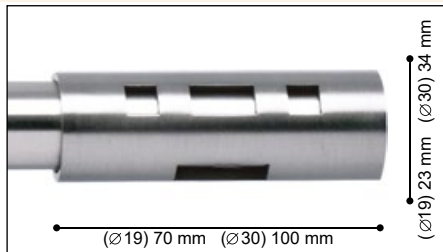

REF	Ø	U	€	€	cm
S.6619A1	19	10	7,32 €	8,42 €	
S.6630A1	30	10	10,78 €	12,40 €	

Tapón

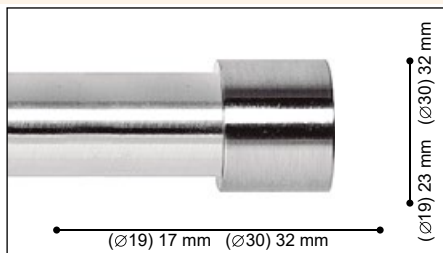

REF	Ø	U	€	€	cm
S.6119A1	19	10	3,72 €	4,28 €	
S.6130A1	30	10	5,78 €	6,65 €	

Creta

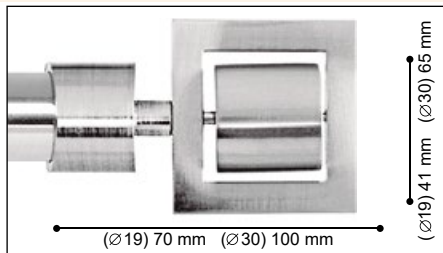

REF	Ø	U	€	€	cm
S.7819A1	19	10	11,40 €	13,11 €	
S.7830A1	30	10	20,24 €	23,28 €	

Rodas

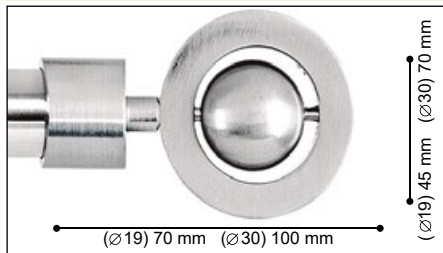

REF	Ø	U	€	€	cm
S.8019A1	19	10	10,80 €	12,42 €	
S.8030A1	30	10	19,68 €	22,63 €	

Media Bola

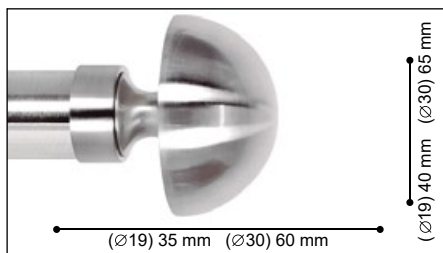

REF	Ø	U	€	€	cm
S.8919A1	19	10	8,54 €	9,82 €	
S.8930A1	30	10	20,64 €	23,74 €	

Aqua

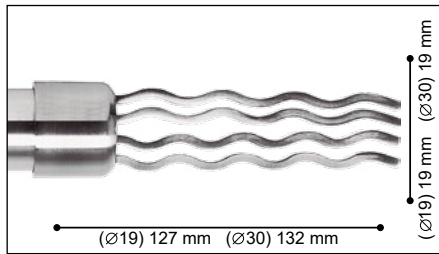

REF	Ø	U	€	€ ¹	cm
P.01219A1	19	10	18,02 €	20,72 €	
P.01230A1	30	10	19,26 €	22,15 €	

Eolo

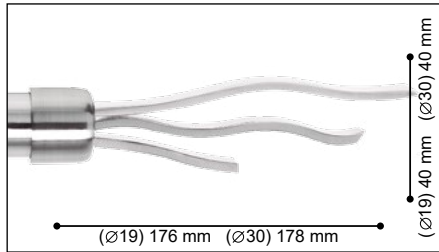

REF	Ø	U	€	€ ¹	cm
P.01019A1	19	10	24,46 €	28,13 €	
P.01030A1	30	10	25,02 €	28,77 €	

Iris

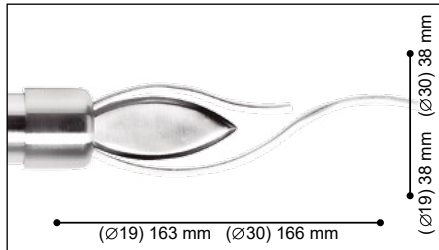

REF	Ø	U	€	€ ¹	cm
P.00919A1	19	10	16,24 €	18,68 €	
P.00930A1	30	10	17,00 €	19,55 €	

Blasón

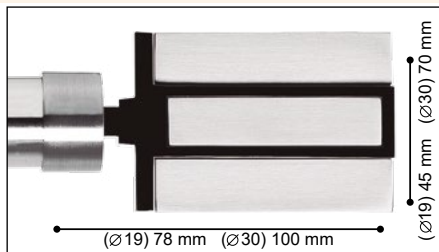

REF	Ø	U	€	€ ¹	cm
P.01619AB1	19	10	13,50 €	15,53 €	
P.01630AB1	30	10	27,48 €	31,60 €	

Olimpo

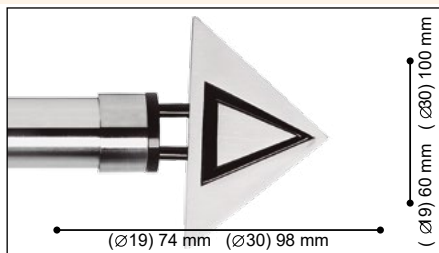

REF	Ø	U	€	€ ¹	cm
P.01519AB1	19	10	12,98 €	14,93 €	
P.01530AB1	30	10	20,28 €	23,32 €	

Atlas

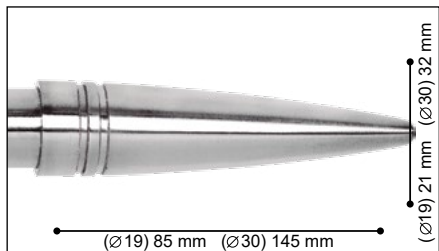

REF	Ø	U	€	€ ¹	cm
P.00019A1	19	10	10,06 €	11,57 €	
P.00030A1	30	10	20,20 €	23,23 €	

Etna

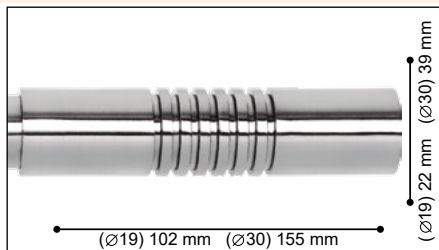

REF	Ø	U	€	€ ¹	cm
P.00119A1	19	10	13,34 €	15,34 €	
P.00130A1	30	10	30,32 €	34,87 €	
P.00119AB1	19	10	12,56 €	14,44 €	
P.00130AB1	30	10	32,18 €	37,01 €	

Vega

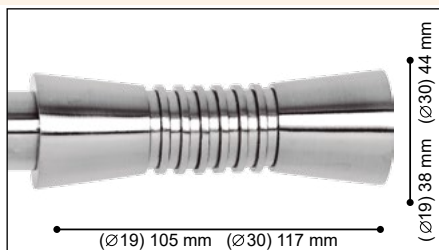

REF	Ø	U	€	€ ¹	cm
P.00219A1	19	10	21,46 €	24,68 €	
P.00230A1	30	10	27,08 €	31,14 €	
P.00219AB1	19	10	22,16 €	25,48 €	
*P.00230AB1	30	10	35,92 €	41,31 €	

* Disponible hasta finalizar existencias /
On sale until end of stock. / Disponible dans la limite des stocks

Solaris

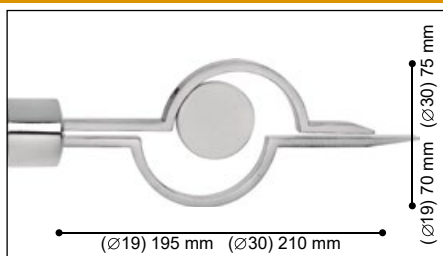

REF	Ø				
P.00819A1	19	10	17,34 €	19,94 €	
P.00830A1	30	10	19,16 €	22,03 €	

Accesorios / Accessories / Accessoires

Soporte Corto

Short Wall Bracket / Support Court

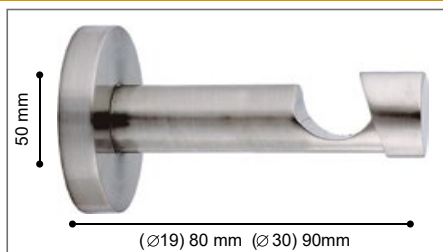

REF	Ø				
S.20519A1	19	10	14,70 €	16,91 €	
S.20530A1	30	10	20,12 €	23,14 €	

Soporte Sencillo

Single Bracket / Support Mur

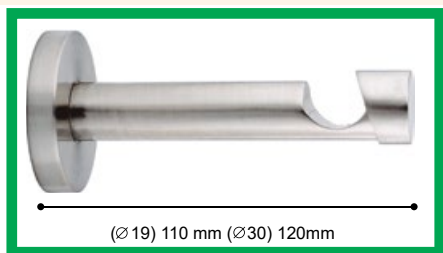

REF	Ø				
S.20619A1	19	10	18,40 €	21,16 €	
S.20630A1	30	10	22,72 €	26,13 €	

* Soporte incluido en el Kit Sencillo / Bracket supplied in the Single Kit / Support fourni dans le Simple Kit.

Soporte Doble

Double Wall Bracket / Support Mur Double

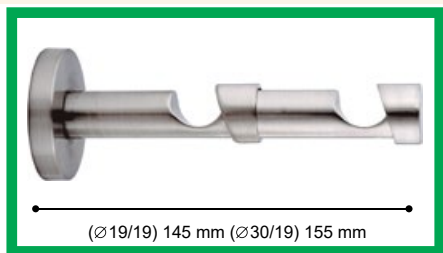

REF	Ø				
S.23119A1	19/19	10	18,38 €	21,14 €	
S.23319A1	30/19	10	25,26 €	29,05 €	

* Soporte incluido en el Kit Doble / Bracket supplied in the Double Kit / Support fourni dans le Double Kit.

Soporte Techo

Ceiling Bracket / Support Plafond



REF	Ø				
S.20719A1	19	10	16,08 €	18,49 €	
S.20730A1	30	10	22,00 €	25,30 €	

Soporte Doble Techo

Double Ceiling Bracket / Support Plafond Double

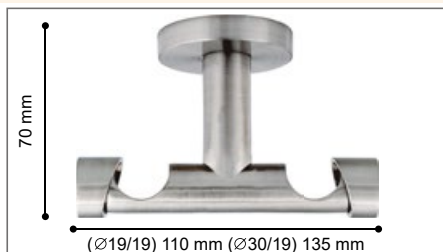

REF	Ø				
S.24119A1	19/19	10	19,56 €	22,49 €	
S.24319A1	30/19	10	27,98 €	32,18 €	

Soporte Dintel

Recess Bracket / Support naissance



REF	Ø				
S.20419A1	19	10	6,40 €	7,36 €	
S.20430A1	30	10	9,20 €	10,58 €	

* Nuevo Sistema que mejora la sujeción de la barra y su resistencia.
New system that improves the pole hold and resistance.
Nouveau système qui permet d'améliorer la fixation et résistance de la tringle.

Accesorios / Accessories / Accessoires

Soporte Triangular

Triangular bracket / Support en triangle



REF	∅	U	€	€	cm
N.8019A	19	10	8,90 €	10,24 €	
N.8030A	30	10	8,90 €	10,24 €	

* Soporte incluido en el Kit Sencillo Vector / Bracket supplied in the Vector Single Kit / Support fourni dans le Simple Kit Vector.

Soporte Cuadrado

Square bracket / Support en Carré

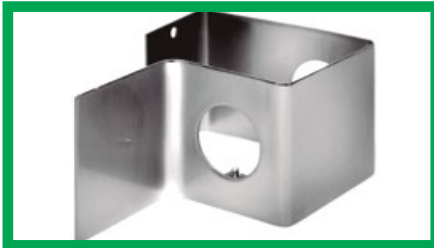

REF	∅	U	€	€	cm
N.9019A	19	10	8,90 €	10,24 €	
N.9030A	30	10	8,90 €	10,24 €	

* Soporte incluido en el Kit Sencillo Vector / Bracket supplied in the Vector Single Kit / Support fourni dans le Simple Kit Vector.

Prolongador

Extender / Prolongateur

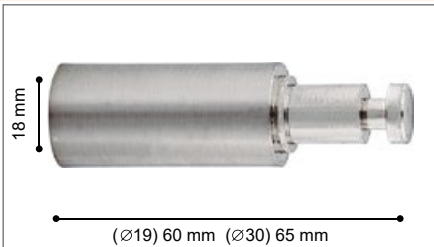

REF	∅	U	€	€	cm
S.20819A1	19	10	4,40 €	5,06 €	
S.20830A1	30	10	9,94 €	11,43 €	

Codo Articulado

Elbow / Coude



REF	∅	U	€	€	cm
S.150A1	19	10	11,60 €	13,34 €	
S.151A1	30	10	17,46 €	20,08 €	

Empalme

Splice / Raccordeur



REF	∅	U	€	€	cm
S.1518H1	19	10	2,94 €	3,38 €	
H.13	30	10	4,78 €	5,50 €	

Empalme Transparente

Transparent Splice / Raccordeur Transparent



REF	∅	U	€	€	cm
H.07M	30	10	25,30 €	29,10 €	

Empalme Negro

Black Splice / Raccordeur Noir



REF	∅	U	€	€	cm
H.07MN	30	10	25,30 €	29,10 €	

Empalme Blanco

White Splice / Raccordeur Blanc



REF	∅	U	€	€	cm
H.07MB	30	10	25,30 €	29,10 €	

Accesorios / Accessories / Accessoires

Barra Acero

Steel Pole /
Tube Acier



REF	∅				
S.19A1501	19	10	13,30 €	15,30 €	150
S.19A2001	19	10	18,48 €	21,25 €	200
S.19A2501	19	10	23,08 €	26,54 €	250
S.19A3001	19	10	27,74 €	31,90 €	300
S.30A1501	30	10	20,86 €	23,99 €	150
S.30A2001	30	10	28,06 €	32,27 €	200
S.30A2501	30	10	35,86 €	41,24 €	250
S.30A3001	30	10	43,32 €	49,82 €	300

Barra Metacrilato

Methacrylate Pole /
Tube Méthacrilate

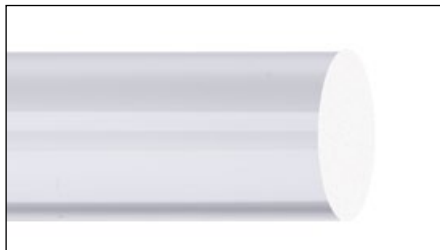

REF	∅				
S.30M1501	30	10	48,20 €	55,43 €	150
S.30M2001	30	10	66,86 €	76,89 €	200
S.30M3001	30	10	96,40 €	110,86 €	300

Barra Metacrilato Negro

Black
Methacrylate Pole /
Tube
Méthacrilate Noir



REF	∅				
S.30MN1501	30	10	47,26 €	54,35 €	150
S.30MN2001	30	10	65,56 €	75,39 €	200
S.30MN2501	30	10	87,10 €	100,17 €	250
S.30MN3001	30	10	94,54 €	108,72 €	300

Barra Metacrilato Blanco

White
Methacrylate Pole /
Tube Méthacrilate
Blanc



REF	∅				
S.30MB1501	30	10	47,26 €	54,35 €	150
S.30MB2001	30	10	65,56 €	75,39 €	200
S.30MB2501	30	10	87,10 €	100,17 €	250

Tirador 1 metro Acero

Curtain steel
draw rod 1m. /
Lance rideau
acier 1m.



REF	∅				
S.20A1	10	1		12,76 €	100

Tirador Metacrilato 1 metro con mango 15 mm

1 m acrylic wand with
handle (15 mm) /
Tireur métacrylate 1 m
avec manche (15 mm)



REF	∅				
L.12	15	1		18,22 €	100

Tirador Metacrilato 1 metro sin mango 15 mm

1 m acrylic wand
without handle
(15 mm) /
Tireur métacrylate 1 m
sans manche (15 mm)



REF	∅				
L.14	15	1		11,74 €	100

Accesorios / Accessories / Accessoires

Anillas metacrilato
Acrylic Rings / Anneaux transparent

REF	∅	U	€	€ ¹	cm
S.21530M10	30	50	1,54 €	1,77 €	

Anillas
Rings / Anneaux

REF	∅	U	€	€ ¹	cm
H.20290	19	100	1,12 €	1,29 €	
H.20390	30	100	1,62 €	1,86 €	



Anilla (6 ó 10 ud. blister)
Ring (6 or 10 pieces per blister) / Anneaux (6 or 10 pieces per blister)

REF	∅	U	€	€ ¹	cm
S.20290A6	19	10	6,52 €	7,50 €	
S.20290A10	19	10	9,92 €	11,41 €	
S.20390A6	30	10	11,90 €	13,69 €	
S.20390A10	30	10	18,26 €	21,00 €	

Soporte Técnico Doble 19/19
Double Technical Bracket / Support Double Technique

REF	∅	U	€	€ ¹	cm
S.41119A1	19/19	10	34,28 €	39,42 €	

Soporte Técnico Doble 30/19
Double Technical Bracket / Support double Technique

REF	∅	U	€	€ ¹	cm
S.41319A1	30/19	10	39,80 €	45,77 €	

SOPRTE TÉCNICOS DOBLES / DOUBLE TECHNICAL BRACKET / SUPPORT TECHNIQUE DOUBLE

Soporte versátil capaz de adaptarse a cualquier tipo de instalación. / Versatile bracket of total reliability in any type of installation. / Support poly valente et apte à s'adapter à tout type d'installation.

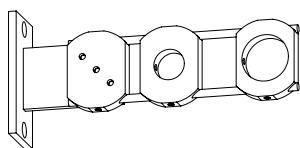

Soporte Técnico Pared Doble
Double technical wall bracket / Support technique mur double

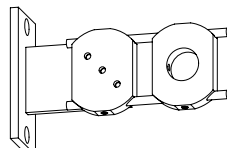

Soporte Pared
Wall bracket / Support mur

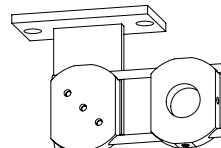

Soporte Techo
Ceiling bracket / Support plafond

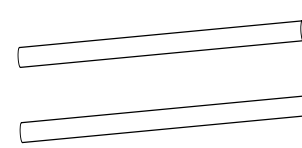

Varillas extra para Soporte Técnico Sencillo
Extra rods included to convert to single bracket / Tige supplémentaire pour support technique simple

Opción A / Option A

Opción B / Option B

Soporte Técnico de Techo Doble
Double technical ceiling bracket / Support technique plafond double

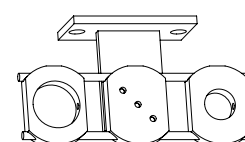
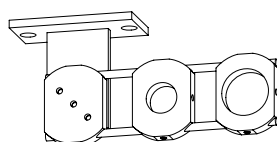

Abrazaderas Design / Designer Holdbacks / Embrasses Design



<p>Anilla Abrazadera Ring Holdback / Anneau-Embrasse</p>		<table border="1"> <thead> <tr> <th>REF</th> <th>∅</th> <th>U</th> <th>€</th> <th>€</th> <th>cm</th> </tr> </thead> <tbody> <tr> <td>H.42PSA</td> <td></td> <td>10</td> <td>12,02 €</td> <td>13,82 €</td> <td></td> </tr> </tbody> </table>	REF	∅	U	€	€	cm	H.42PSA		10	12,02 €	13,82 €		<p>* Cada cara del magneto tiene un acabado diferente (acero y plata satinada), ofreciendo así 2 posibilidades en 1 sola pieza. / Each side of the Magneto has a different finish (steel & satin Nickel), thus offering 2 options with just one piece. / Chaque face a une finition différente (acier et Nickel satiné) offrant de fait 2 options sur une seule pièce.</p>						
REF	∅	U	€	€	cm																
H.42PSA		10	12,02 €	13,82 €																	
<p>Anilla Abrazadera Ring Holdback / Anneau-Embrasse</p>		<table border="1"> <thead> <tr> <th>REF</th> <th>∅</th> <th>U</th> <th>€</th> <th>€</th> <th>cm</th> </tr> </thead> <tbody> <tr> <td>H.43PSA</td> <td></td> <td>10</td> <td>12,88 €</td> <td>14,81 €</td> <td></td> </tr> </tbody> </table>	REF	∅	U	€	€	cm	H.43PSA		10	12,88 €	14,81 €		<p>* Cada cara del magneto tiene un acabado diferente (acero y plata satinada), ofreciendo así 2 posibilidades en 1 sola pieza. / Each side of the Magneto has a different finish (steel & satin Nickel), thus offering 2 options with just one piece. / Chaque face a une finition différente (acier et Nickel satiné) offrant de fait 2 options sur une seule pièce.</p>						
REF	∅	U	€	€	cm																
H.43PSA		10	12,88 €	14,81 €																	
<p>“S” Anilla Abrazadera Ring Holdback / Anneau-Embrasse</p>		<table border="1"> <thead> <tr> <th>REF</th> <th>∅</th> <th>U</th> <th>€</th> <th>€</th> <th>cm</th> </tr> </thead> <tbody> <tr> <td>R.1518A</td> <td></td> <td>10</td> <td>16,98 €</td> <td>19,53 €</td> <td></td> </tr> <tr> <td>R.1518C</td> <td></td> <td>10</td> <td>16,98 €</td> <td>19,53 €</td> <td></td> </tr> </tbody> </table>	REF	∅	U	€	€	cm	R.1518A		10	16,98 €	19,53 €		R.1518C		10	16,98 €	19,53 €		
REF	∅	U	€	€	cm																
R.1518A		10	16,98 €	19,53 €																	
R.1518C		10	16,98 €	19,53 €																	
<p>Cuadrada Anilla Abrazadera Ring Holdback / Anneau-Embrasse</p>		<table border="1"> <thead> <tr> <th>REF</th> <th>∅</th> <th>U</th> <th>€</th> <th>€</th> <th>cm</th> </tr> </thead> <tbody> <tr> <td>R.1519A</td> <td></td> <td>10</td> <td>14,90 €</td> <td>17,14 €</td> <td></td> </tr> <tr> <td>R.1519C</td> <td></td> <td>10</td> <td>14,90 €</td> <td>17,14 €</td> <td></td> </tr> </tbody> </table>	REF	∅	U	€	€	cm	R.1519A		10	14,90 €	17,14 €		R.1519C		10	14,90 €	17,14 €		
REF	∅	U	€	€	cm																
R.1519A		10	14,90 €	17,14 €																	
R.1519C		10	14,90 €	17,14 €																	
<p>Redonda Anilla Abrazadera Ring Holdback / Anneau-Embrasse</p>		<table border="1"> <thead> <tr> <th>REF</th> <th>∅</th> <th>U</th> <th>€</th> <th>€</th> <th>cm</th> </tr> </thead> <tbody> <tr> <td>R.1521A</td> <td></td> <td>10</td> <td>15,62 €</td> <td>17,96 €</td> <td></td> </tr> <tr> <td>R.1521C</td> <td></td> <td>10</td> <td>15,62 €</td> <td>17,96 €</td> <td></td> </tr> </tbody> </table>	REF	∅	U	€	€	cm	R.1521A		10	15,62 €	17,96 €		R.1521C		10	15,62 €	17,96 €		
REF	∅	U	€	€	cm																
R.1521A		10	15,62 €	17,96 €																	
R.1521C		10	15,62 €	17,96 €																	
<p>Ovalada Anilla Abrazadera Ring Holdback / Anneau-Embrasse</p>		<table border="1"> <thead> <tr> <th>REF</th> <th>∅</th> <th>U</th> <th>€</th> <th>€</th> <th>cm</th> </tr> </thead> <tbody> <tr> <td>R.1522A</td> <td></td> <td>10</td> <td>16,02 €</td> <td>18,42 €</td> <td></td> </tr> <tr> <td>R.1522C</td> <td></td> <td>10</td> <td>16,02 €</td> <td>18,42 €</td> <td></td> </tr> </tbody> </table>	REF	∅	U	€	€	cm	R.1522A		10	16,02 €	18,42 €		R.1522C		10	16,02 €	18,42 €		
REF	∅	U	€	€	cm																
R.1522A		10	16,02 €	18,42 €																	
R.1522C		10	16,02 €	18,42 €																	

Barra de Cortina CAVALLIER / Curtain Pole CAVALLIER / Tringle a Rideux CAVALLIER

- Colección **Artesanal** fabricada Pieza a Pieza manualmente.
Handcrafted collection manufactured piece by piece.
 Création **Artisanal** produite pièce par pièce manuellement.

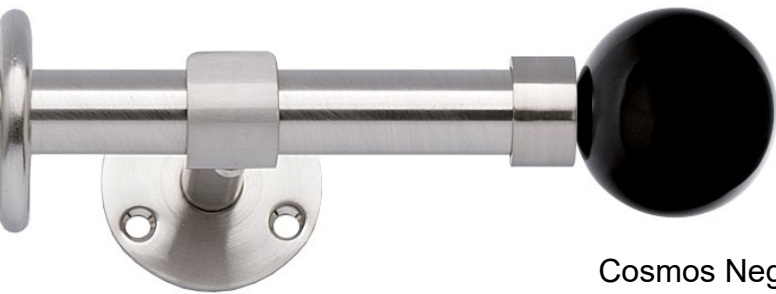

Cosmos Negro

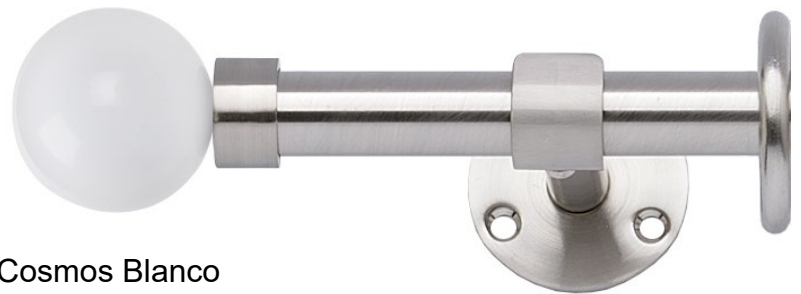

Cosmos Blanco



Cosmos Oro



Cosmos Bronce

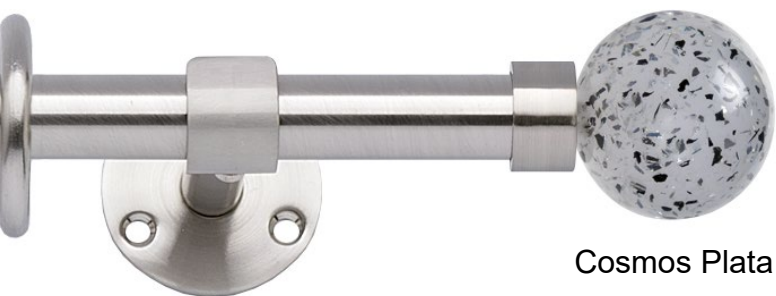

Cosmos Plata

Corona Altran con
Cristales Swarovski®

Corona Lisa



Corona Trono

■ Hemos querido renovar esta completa introduciendo nuevos terminales que se pueden combinar con colecciones como Infinity o Varadero debido a su acabado metálico en color Acero y Cuero. Cavallier se convierte en la colección más moderna del mercado debido a las formas de los terminales que dan vida a esta colección de altísima calidad.

■ We wanted to renew this collection by introducing new finials that can be combined with other collections such as Infinity or Varadero due to its metallic finish in Steel and Leather. The Cavallier collection becomes the most modern collection of the market due to their finial shapes that give a feeling to this top-quality collection.

■ Nous avons voulu renouveler cette collection en introduisant de nouvelles embouts qui peuvent être combinées avec d'autres collections comme Infinity ou Varadero en raison de sa finition métallique en acier et en cuir. La collection Cavallier devient la collection la plus moderne du marché en raison des formes de leurs embouts qui donnent un sentiment à cette collection de qualité supérieure.



Cubis



Corneta Acero



Hoja



Sol Cuero



Púa



Terra Acero



Tapón Cuero



Espiral Cuero

Ø 19 / 30 mm

Conjuntos completos CAVALLIER /
Complete sets CAVALLIER /
Kits complete CAVALLIER

(**) Conjunto dobles: La Barra 19mm se sirve con piña tapón.
(**) Double sets: Pole of 19 mm with finial endcap.
(**) Kits doubles: Barre de 19 mm avec embout bouchon.



Cosmos Negro



U	Ø 19 REF K.2418_08	Ø 30 REF K.2407_08	Ø 19/19 (**) REF K.2419_08	Ø 30/19 (**) REF K.2421_08	cm	cm
1	117,30 €	155,60 €	208,43 €	244,93 €	16	150
1	127,42 €	167,79 €	228,67 €	267,24 €	20	200
1	156,03 €	204,56 €	272,80 €	318,64 €	26	250
1	165,55 €	217,05 €	291,85 €	340,65 €	30	300
1	*192,88 €	*253,25 €	*346,50 €	*404,18 €	40	400

Cosmos Blanco

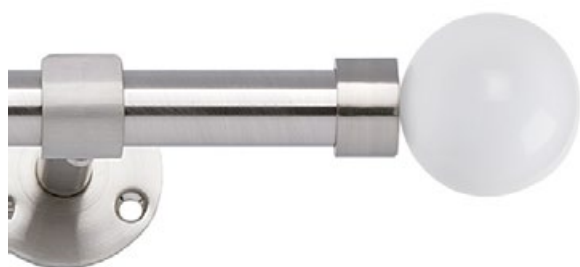

U	Ø 19 REF K.2418_09	Ø 30 REF K.2407_09	Ø 19/19 (**) REF K.2419_09	Ø 30/19 (**) REF K.2421_09	cm	cm
1	117,30 €	155,60 €	208,43 €	244,93 €	16	150
1	127,42 €	167,79 €	228,67 €	267,24 €	20	200
1	156,03 €	204,56 €	272,80 €	318,64 €	26	250
1	165,55 €	217,05 €	291,85 €	340,65 €	30	300
1	*192,88 €	*253,25 €	*346,50 €	*404,18 €	40	400

Cosmos Oro



U	Ø 19 REF K.2418_10	Ø 30 REF K.2407_10	Ø 19/19 (**) REF K.2419_10	Ø 30/19 (**) REF K.2421_10	cm	cm
1	131,70 €	182,78 €	237,22 €	286,51 €	16	150
1	141,82 €	194,97 €	257,46 €	308,82 €	20	200
1	170,43 €	231,75 €	301,60 €	360,23 €	26	250
1	179,95 €	244,24 €	320,64 €	382,24 €	30	300
1	*207,28 €	*280,44 €	*375,29 €	*445,76 €	40	400

Cosmos Bronce



U	Ø 19 REF K.2418_11	Ø 30 REF K.2407_11	Ø 19/19 (**) REF K.2419_11	Ø 30/19 (**) REF K.2421_11	cm	cm
1	131,70 €	182,78 €	237,22 €	286,51 €	16	150
1	141,82 €	194,97 €	257,46 €	308,82 €	20	200
1	170,43 €	231,75 €	301,60 €	360,23 €	26	250
1	179,95 €	244,24 €	320,64 €	382,24 €	30	300
1	*207,28 €	*280,44 €	*375,29 €	*445,76 €	40	400

Cosmos Plata



U	Ø 19 REF K.2418_12	Ø 30 REF K.2407_12	Ø 19/19 (**) REF K.2419_12	Ø 30/19 (**) REF K.2421_12	cm	cm
1	131,70 €	182,78 €	237,22 €	286,51 €	16	150
1	141,82 €	194,97 €	257,46 €	308,82 €	20	200
1	170,43 €	231,75 €	301,60 €	360,23 €	26	250
1	179,95 €	244,24 €	320,64 €	382,24 €	30	300
1	*207,28 €	*280,44 €	*375,29 €	*445,76 €	40	400

Corona Altran con Cristales Swarovski®



U	Ø 19 REF K.27918	Ø 30 REF K.2707	Ø 19/19 (**) REF K.2719	Ø 30/19 (**) REF K.2721	cm	cm
1	120,80 €	149,89 €	215,42 €	242,72 €	16	150
1	130,92 €	162,08 €	235,66 €	265,03 €	20	200
1	159,53 €	198,86 €	279,80 €	316,43 €	26	250
1	169,05 €	211,35 €	298,84 €	338,45 €	30	300
1	*196,37 €	*247,55 €	*353,49 €	*401,97 €	40	400

Conjuntos completos CAVALLIER /
Complete sets CAVALLIER /
Kits complete CAVALLIER

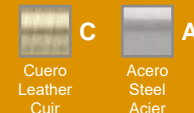

Corona Lisa



U	Ø 19 REF K.2518	Ø 30 REF K.2507	Ø 19/19 REF K.2519	Ø 30/19 REF K.2521	Q	cm
1	83,49 €	112,45 €	140,81 €	167,97 €	16	150
1	93,61 €	124,64 €	161,05 €	190,28 €	20	200
1	122,22 €	161,41 €	205,18 €	241,68 €	26	250
1	131,74 €	173,90 €	224,23 €	263,70 €	30	300
1	*159,07 €	*210,11 €	*278,88 €	*327,22 €	40	400

Corona Trono



U	Ø 19 REF K.2618	Ø 30 REF K.2607	Ø 19/19 REF K.2619	Ø 30/19 REF K.2621	Q	cm
1	83,49 €	112,45 €	140,81 €	167,97 €	16	150
1	93,61 €	124,64 €	161,05 €	190,28 €	20	200
1	122,22 €	161,41 €	205,18 €	241,68 €	26	250
1	131,74 €	173,90 €	224,23 €	263,70 €	30	300
1	*159,07 €	*210,11 €	*278,88 €	*327,22 €	40	400

Cubis

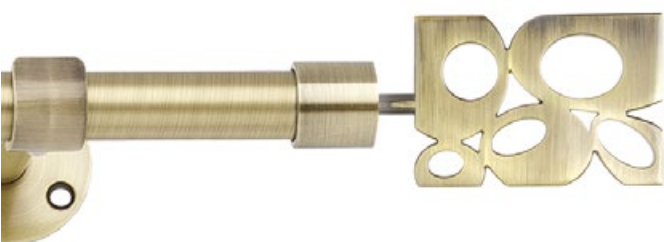

U	Ø 19 REF K.7518	Ø 30 REF K.7507	Ø 19/19 REF K.7519	Ø 30/19 REF K.7521	Q	cm
1	84,64 €	108,91 €	143,11 €	165,58 €	16	150
1	94,76 €	121,10 €	163,35 €	187,89 €	20	200
1	123,37 €	157,87 €	207,48 €	239,29 €	26	250
1	132,89 €	170,36 €	226,53 €	261,30 €	30	300
1	*160,22 €	*206,56 €	*281,18 €	*324,83 €	40	400

Hoja



U	Ø 19 REF K.7618	Ø 30 REF K.7607	Ø 19/19 REF K.7619	Ø 30/19 REF K.7621	Q	cm
1	87,68 €	108,91 €	149,18 €	168,61 €	16	150
1	97,80 €	121,10 €	169,42 €	190,92 €	20	200
1	126,41 €	157,87 €	213,56 €	242,33 €	26	250
1	135,93 €	170,36 €	232,60 €	264,34 €	30	300
1	*163,25 €	*206,56 €	*287,25 €	*327,87 €	40	400

Púa



U	Ø 19 REF K.7818	Ø 30 REF K.7807	Ø 19/19 REF K.7819	Ø 30/19 REF K.7821	Q	cm
1	83,90 €	107,30 €	141,63 €	163,23 €	16	150
1	94,02 €	119,49 €	161,87 €	185,54 €	20	200
1	122,64 €	156,26 €	206,01 €	236,95 €	26	250
1	132,16 €	168,75 €	225,06 €	258,96 €	30	300
1	*159,48 €	*204,95 €	*279,70 €	*322,48 €	40	400

Corneta



U	Ø 19 REF K.7418	Ø 30 REF K.7407	Ø 19/19 REF K.7419	Ø 30/19 REF K.7421	Q	cm
1	96,05 €	118,57 €	165,92 €	186,65 €	16	150
1	106,17 €	130,76 €	186,16 €	208,96 €	20	200
1	134,78 €	167,53 €	230,30 €	260,36 €	26	250
1	144,30 €	180,02 €	249,34 €	282,37 €	30	300
1	*163,90 €	*216,22 €	*303,99 €	*345,90 €	40	400

Conjuntos completos CAVALLIER /
Complete sets CAVALLIER /
Kits complete CAVALLIER

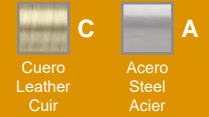

Sol



U	Ø 19 REF K.7218	Ø 30 REF K.7207	Ø 19/19 REF K.7219	Ø 30/19 REF K.7221	cm	cm
1	81,97 €	103,75 €	137,77 €	157,76 €	16	150
1	92,09 €	115,94 €	158,01 €	180,07 €	20	200
1	120,70 €	152,72 €	202,15 €	231,47 €	26	250
1	130,23 €	165,21 €	221,19 €	253,48 €	30	300
1	*157,55 €	*201,41 €	*275,84 €	*310,57 €	40	400

Terra



U	Ø 19 REF K.7318	Ø 30 REF K.7307	Ø 19/19 REF K.7319	Ø 30/19 REF K.7321	cm	cm
1	88,32 €	109,04 €	150,47 €	169,40 €	16	150
1	98,44 €	121,23 €	170,71 €	191,71 €	20	200
1	127,05 €	158,01 €	214,84 €	243,11 €	26	250
1	136,57 €	170,50 €	233,89 €	265,12 €	30	300
1	*163,90 €	*196,12 €	*288,54 €	*325,27 €	40	400

Espiral



U	Ø 19 REF K.7118	Ø 30 REF K.7107	Ø 19/19 REF K.7119	Ø 30/19 REF K.7121	cm	cm
1	82,62 €	104,40 €	139,06 €	159,05 €	16	150
1	92,74 €	116,59 €	159,30 €	181,36 €	20	200
1	121,35 €	153,36 €	203,44 €	232,76 €	26	250
1	130,87 €	165,85 €	222,48 €	254,77 €	30	300
1	*158,19 €	*202,06 €	*277,13 €	*318,30 €	40	400

Tapón



U	Ø 19 REF K.7718	Ø 30 REF K.7707	Ø 19/19 REF K.7719	Ø 30/19 REF K.7721	cm	cm
1	74,66 €	96,81 €	123,14 €	143,50 €	16	150
1	84,78 €	109,00 €	143,38 €	165,81 €	20	200
1	113,39 €	145,77 €	187,52 €	217,21 €	26	250
1	122,91 €	158,26 €	206,56 €	239,22 €	30	300
1	*150,24 €	*194,47 €	*261,21 €	*302,75 €	40	400

Contenido del Kit / Kit components / Composants du Kit



- * Se sirven empalmados.
- Conjuntos Sencillos:
2 terminales, 2 soportes, barra y anillas.
- Conjuntos dobles:
4 term., 2 sop.dobles, 2 barras y anillas.
- Los conjuntos de medida superior a 2m se sirven con 3 soportes.
- Indique en su pedido el acabado y la medida de la barra que desea.
- Conjunto Dobles: Se sirven con el mismo terminal para ambas barras.



- * Supplied in 2 halves.
- Single sets:
2 finials, 2 brackets, pole & rings.
- Double sets:
4 finials, 2 double brackets, 2 poles & rings.
- All sets with a length longer than 2 meters are supplied with 3 brackets.
- When ordering, please specify finish and size of pole.
- Double sets: The Double Sets are supplied with the same finials in both poles.



- * Fourni en 2 parties.
- Kits simples:
2 embouts, 2 supports, tube et anneaux.
- Kits doubles: 4 embouts, 2 supports doubles, 2 tubes et anneaux.
- Tous les kits de mesures supérieures à 2 mètres contiennent 3 supports.
- Merci de spécifier la finition et la taille de la barre.
- Kits doubles: Sont fournis avec les mêmes embouts pour les deux tringles.

Cosmos Negro



REF	∅				
P.241908A	19	2	22,26 €	25,60 €	
P.241908C	19	2	22,26 €	25,60 €	
P.243008A	30	2	31,34 €	36,04 €	
P.243008C	30	2	31,34 €	36,04 €	

Cosmos Blanco

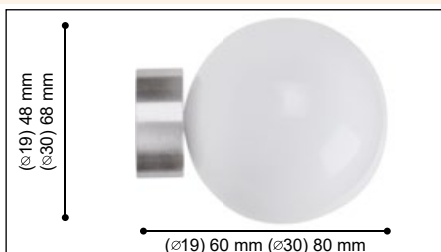

REF	∅				
P.241909A	19	2	22,26 €	25,60 €	
P.241909C	19	2	22,26 €	25,60 €	
P.243009A	30	2	31,34 €	36,04 €	
P.243009C	30	2	31,34 €	36,04 €	

Cosmos Oro



REF	∅				
P.241910A	19	2	28,52 €	32,80 €	
P.241910C	19	2	28,52 €	32,80 €	
P.243010A	30	2	43,16 €	49,63 €	
P.243010C	30	2	43,16 €	49,63 €	

Cosmos Bronce



REF	∅				
P.241911A	19	2	28,52 €	32,80 €	
P.241911C	19	2	28,52 €	32,80 €	
P.243011A	30	2	43,16 €	49,63 €	
P.243011C	30	2	43,16 €	49,63 €	

Cosmos Plata

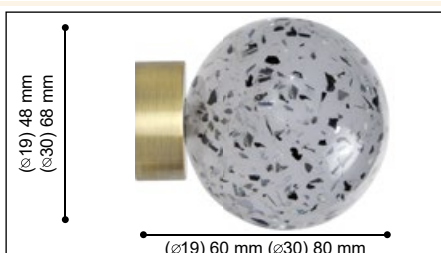

REF	∅				
P.241912A	19	2	28,52 €	32,80 €	
P.241912C	19	2	28,52 €	32,80 €	
P.243012A	30	2	43,16 €	49,63 €	
P.243012C	30	2	43,16 €	49,63 €	

Corona Lisa

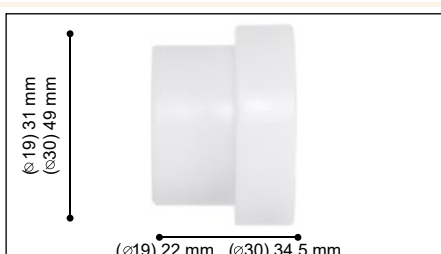

REF	∅				
P.251909	19	2	7,56 €	8,69 €	
P.253009	30	2	12,58 €	14,47 €	

Corona Altran con Cristales Swarovski®



REF	∅				
P.271909	19	2	23,78 €	27,35 €	
P.273009	30	2	28,86 €	33,19 €	

Corona Trono



REF	∅				
P.261909	19	10	7,56 €	8,69 €	
P.263009	30	10	12,58 €	14,47 €	

Cubis

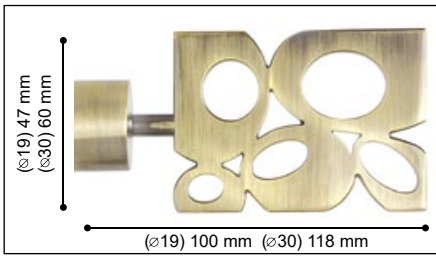

REF	∅	U	€	€ ¹	cm
S.5219A1	19	10	8,06 €	9,27 €	
S.5219C1	19	10	8,06 €	9,27 €	
S.5230A1	30	10	11,04 €	12,70 €	
S.5230C1	30	10	11,04 €	12,70 €	

Hoja

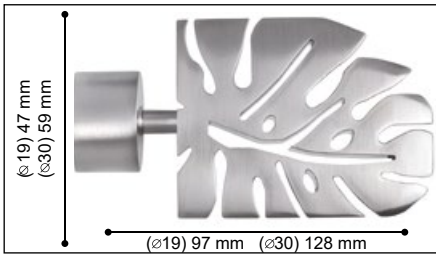

REF	∅	U	€	€ ¹	cm
S.5019A1	19	10	9,38 €	10,79 €	
S.5019C1	19	10	9,38 €	10,79 €	
S.5030A1	30	10	11,04 €	12,70 €	
S.5030C1	30	10	11,04 €	12,70 €	

Púa

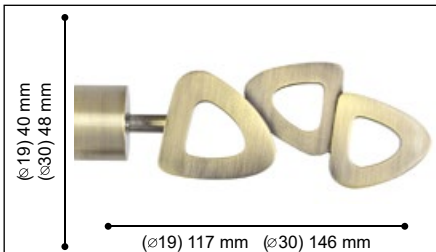

REF	∅	U	€	€ ¹	cm
S.5119A1	19	10	7,74 €	8,90 €	
S.5119C1	19	10	7,74 €	8,90 €	
S.5130A1	30	10	10,34 €	11,89 €	
S.5130C1	30	10	10,34 €	11,89 €	

Corneta

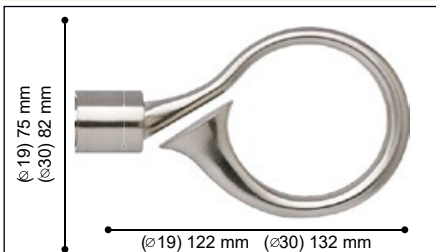

REF	∅	U	€	€ ¹	cm
S.6019A1	19	10	13,02 €	14,97 €	
S.6019C1	19	10	13,02 €	14,97 €	
S.6030A1	30	10	15,24 €	17,53 €	
S.6030C1	30	10	15,24 €	17,53 €	

Sol

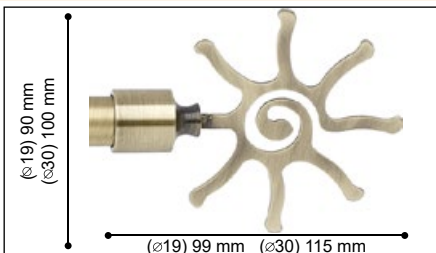

REF	∅	U	€	€ ¹	cm
S.5819A1	19	10	6,90 €	7,94 €	
S.5819C1	19	10	6,90 €	7,94 €	
S.5830A1	30	10	8,80 €	10,12 €	
S.5830C1	30	10	8,80 €	10,12 €	

Terra

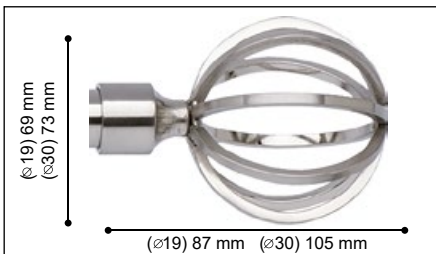

REF	∅	U	€	€ ¹	cm
S.1619A1	19	10	9,66 €	11,11 €	
S.1619C1	19	10	9,66 €	11,11 €	
S.1630A1	30	10	11,10 €	12,77 €	
S.1630C1	30	10	11,10 €	12,77 €	

Espiral



REF	∅	U	€	€ ¹	cm
S.5919A1	19	10	7,18 €	8,26 €	
S.5919C1	19	10	7,18 €	8,26 €	
S.5930A1	30	10	9,08 €	10,44 €	
S.5930C1	30	10	9,08 €	10,44 €	

Tapón

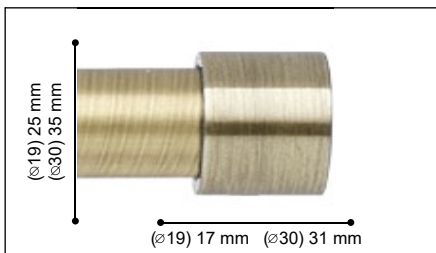

REF	∅	U	€	€ ¹	cm
S.6119A1	19	10	3,72 €	4,28 €	
S.6119C1	19	10	3,72 €	4,28 €	
S.6130A1	30	10	5,78 €	6,65 €	
S.6130C1	30	10	5,78 €	6,65 €	

SopORTE extensible

Extendible wall bracket / Support mur extensible

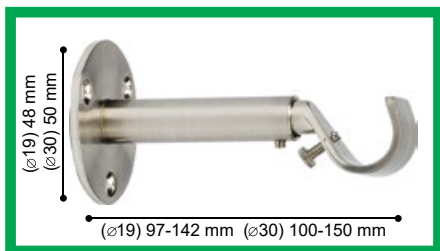

REF	∅				
S.20019A1	19	10	12,30 €	14,15 €	
S.20019C1	19	10	12,30 €	14,15 €	
S.20030A1	30	10	13,68 €	15,73 €	
S.20030C1	30	10	13,68 €	15,73 €	

* Soporte incluido en el Kit Sencillo / Bracket supplied in the Single Kit / Support fourni dans le Simple Kit.

SopORTE doble extensible

Double extendible wall bracket / Support mur extensible double

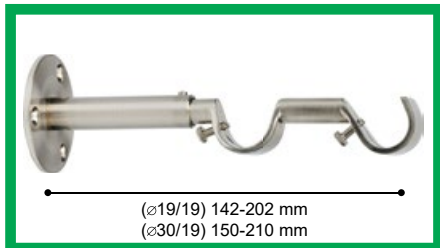

REF	∅				
S.21119A1	19/19	10	13,22 €	15,20 €	
S.21119C1	19/19	10	13,22 €	15,20 €	
S.21319A1	30/19	10	13,82 €	15,89 €	
S.21319C1	30/19	10	13,82 €	15,89 €	

* Soporte incluido en el Kit Doble / Bracket supplied in the Double Kit / Support fourni dans le Double Kit.

SopORTE techo sencillo

Simple ceiling bracket / Support plafond



REF	∅				
S.20119A1	19	10	5,10 €	5,87 €	
S.20119C1	19	10	5,10 €	5,87 €	
S.20130A1	30	10	5,66 €	6,51 €	
S.20130C1	30	10	5,66 €	6,51 €	

SopORTE techo

Ceiling bracket / Support plafond



REF	∅				
S.20919A1	19	10	12,26 €	14,10 €	
S.20919C1	19	10	12,26 €	14,10 €	
S.20930A1	30	10	13,32 €	15,32 €	
S.20930C1	30	10	13,32 €	15,32 €	

SopORTE techo doble

Double ceiling bracket / Support plafond double



REF	∅				
S.25119A1	19/19	10	16,06 €	18,47 €	
S.25119C1	19/19	10	16,06 €	18,47 €	
S.25130A1	30/19	10	17,22 €	19,80 €	
S.25130C1	30/19	10	17,22 €	19,80 €	

SopORTE doble techo sencillo

Double ceiling bracket / Support plafond double



REF	∅				
S.22119A1	19/19	10	6,20 €	7,13 €	
S.22119C1	19/19	10	6,20 €	7,13 €	
S.22319A1	30/19	10	10,54 €	12,12 €	
S.22319C1	30/19	10	10,54 €	12,12 €	

SopORTE dintel

Recess bracket / Support naissance

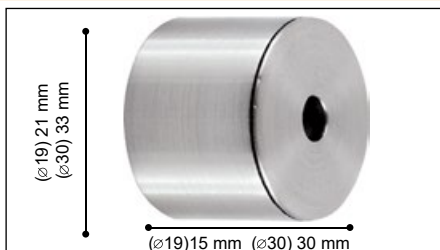

REF	∅				
S.20419A1	19	10	6,40 €	7,36 €	
S.20419C1	19	10	6,40 €	7,36 €	
S.20430A1	30	10	9,20 €	10,58 €	
S.20430C1	30	10	9,20 €	10,58 €	

Codo

Elbow / Coude



REF	∅				
S.150A1	19	10	11,60 €	13,34 €	
S.150C1	19	10	11,60 €	13,34 €	
S.151A1	30	10	17,46 €	20,08 €	
S.151C1	30	10	17,46 €	20,08 €	

Empalme

Splice /
Raccordeur

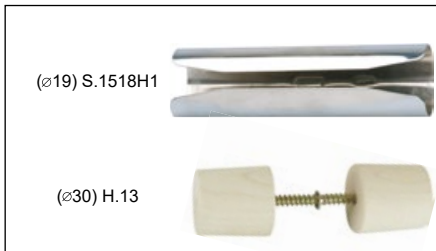

REF	∅	U	€	€ ¹	cm
S.1518H1	19	10	2,94 €	3,38 €	
H.13	30	10	4,78 €	5,50 €	

Soporte Refuerzo
Extensible
15 cm - 20 cm
Reinforcing
extendible brackets
15-20cms /
Supports de renfor-
cement extensibles
15-20cms

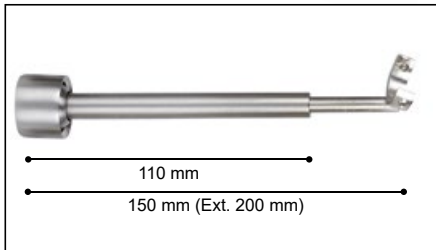

REF	∅	U	€	€ ¹	cm
N.502A		10	19,96 €	22,95 €	
N.502CC		10	19,96 €	22,95 €	

* Compatible con Soportes / Compatible with brackets / Compatible avec supports:

- S.20019A1 · S.20019C1 · S.20030A1 · S.20030C1
- S.21119A1 · S.21119C1 · S.21319A1 · S.21319C1

Anilla (6ud.)
con teflón

Ring (6 pieces)
with teflon /
Anneaux (6
pieces)
avec teflon

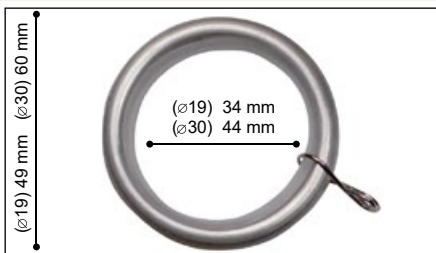

REF	∅	U	€	€ ¹	cm
S.20730A6	19	10	7,98 €	9,18 €	
S.20730C6	19	10	7,98 €	9,18 €	
S.20830A6	30	10	10,50 €	12,08 €	
S.20830C6	30	10	10,50 €	12,08 €	

Anilla (10ud.)
con teflón

Ring (10 pieces)
with teflon /
Anneaux (10 pieces)
avec teflon

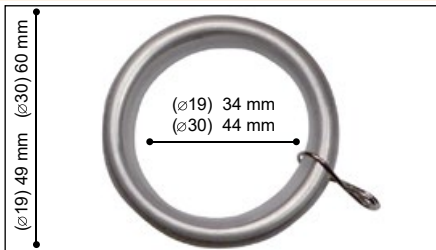

REF	∅	U	€	€ ¹	cm
S.20730A10	19	10	11,60 €	13,34 €	
S.20730C10	19	10	11,60 €	13,34 €	
S.20830A10	30	10	13,90 €	15,99 €	
S.20830C10	30	10	13,90 €	15,99 €	

Gancho

Hooks /
Gonds



REF	∅	U	€	€ ¹	cm
S.1A1		10	5,66 €	6,51 €	4,5
S.1C1		10	5,66 €	6,51 €	4,5

Prolongador

Spindle /
Balustre

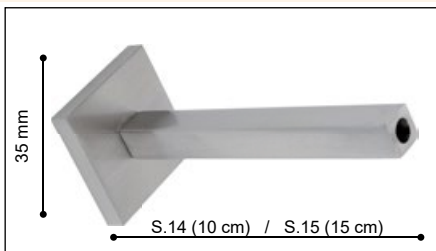

REF	∅	U	€	€ ¹	cm
S.14A1		10	7,96 €	9,15 €	10
S.14C1		10	7,96 €	9,15 €	10
S.15A1		10	9,14 €	10,51 €	15
S.15C1		10	9,14 €	10,51 €	15

Rosetón

Rosette /
Rosace

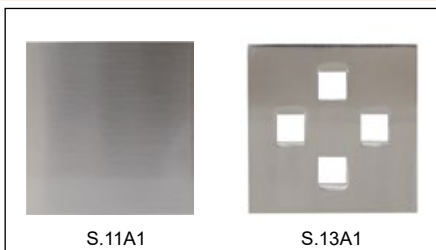

REF	∅	U	€	€ ¹	cm
S.11A1		10	11,48 €	13,20 €	6
S.11C1		10	11,48 €	13,20 €	6
S.13A1		10	11,70 €	13,46 €	6
S.13C1		10	11,70 €	13,46 €	6

Tirador 1 metro

Curtain Draw
Rod 1 m. /
Lance Rideau
1 m.



REF	∅	U	€	€ ¹	cm
S.20A1		1		12,76 €	
S.20C1		1		12,76 €	

Barra Acero
A

Steel Pole /
Tube Acier



REF: A

Barra Cuero
C

Leather Pole /
Tube Cuir



REF: C

REF	A	C	∅	U	€	€	cm
S.19_1501			19	10	13,30 €	15,30 €	150
S.19_2001			19	10	18,48 €	21,25 €	200
S.19_2501			19	10	23,08 €	26,54 €	250
S.19_3001			19	10	27,74 €	31,90 €	300
S.30_1501			30	10	20,86 €	23,99 €	150
S.30_2001			30	10	28,06 €	32,27 €	200
S.30_2501			30	10	35,86 €	41,24 €	250
S.30_3001			30	10	43,32 €	49,82 €	300

Expositor
CAVALLIER 1

CAVALLIER 1
Display Board /
Presentoir
CAVALLIER 1



REF	∅	U	€	€	cm
M.206		1		54,62 €	

Expositor
CAVALLIER 2

CAVALLIER 2
Display Board /
Presentoir
CAVALLIER 2



REF	∅	U	€	€	cm
M.216		1		54,62 €	

Expositor
CAVALLIER 3

CAVALLIER 3
Display Board /
Presentoir
CAVALLIER 3



REF	∅	U	€	€	cm
M.220		1		135,96 €	



Omán



Kabul



Copa



Bola



Cilindro



Tapón

■ **Titanio /**
Titanium /
Titanium



Presentamos un nuevo color, el color Titanio para la colección Varadero. Este moderno color es un color exclusivo de Altran que hemos aplicado a algunos de los terminales más exitosos de la colección.

Este peculiar color y su magnífico acabado, recoge el color de la estancia de modo que si la estancia tiene una iluminación cálida, el color Titanio se volverá un poco más azulado-morado y si la luz es blanca se tornará un color más cercano al negro. El color Titanio potencia el estilo decorativo de la habitación permitiendo una combinación óptima entre iluminación y decoración.

La relación calidad-precio, hace de esta colección la mejor opción en esta gama y una de las más extensas y completas. Con estas Novedades, disponemos de 6 conjuntos color Titanio, 7 conjuntos en color blanco y 11 conjuntos más en colores plata mate, acero, cuero mate y cuero brillo. Por supuesto con sus complementos a juego.

 We present a new color, the Titanium color for the Varadero collection. This modern color is an exclusive creation by Altran that we have extended to some of the most successful finials in the collection.

This peculiar color and its magnificent finish, collects the color of the room so that if the room has a warm lighting, the color Titanium will become a bit more bluish-purple and if the light is white it will turn a color closer to black. The Titanium color enhances the decorative style of the room allowing an optimal combination between lighting and decoration.

The quality-price ratio makes this collection the best option in this range and one of the most extensive and complete. With these news, we have 6 sets of Titanium color, 7 sets in white and 11 more sets in matte silver, steel, matte leather and shiny leather. Of course with its matching accessories.

 Nous présentons une nouvelle couleur, la couleur Titanium pour la collection Varadero. Cette moderne couleur est une création exclusive d'Altran que nous avons étendue à certains des embouts les plus réussis de la collection.

Cette couleur particulière et sa finition magnifique rassemblent la couleur de la pièce. Ainsi, si la pièce est très chaude, la couleur Titanium deviendra un peu plus violet-bleu et si la lumière est blanche, elle deviendra plus noire. La couleur titanium rehausse le style décoratif de la pièce en permettant une combinaison optimale entre éclairage et décoration.

Le rapport qualité-prix fait de cette collection la meilleure option de cette gamme et l'une des plus complètes. Avec ces nouvelles, nous avons 6 kits de couleur Titanium, 7 kits en blanc et 11 autres en argent mat, acier, cuir mat et cuir brillant. Bien sûr avec ses accessoires assortis.

Cuero Brillo
Leather
Cuir

Cuero Mate
Matt Leather
Cuir Matt



Omán



Omán



Kabul



Kabul



Tors



Tors



Truncado



Truncado



Copa Combinada



Copa Combinada



Cono Combinado



Cono Combinado

Ø 19 / 30 mm

Acero ■
Steel
Acier

■ Plata Mate
Matt Nickel
Nickel Satiné



Omán



Omán



Kabul



Kabul



Tors



Tors



Truncado



Truncado



Copa Combinada



Copa Combinada



Cono Combinado



Cono Combinado

Cuero Brillo ■
Leather
Cuir

■ **Cuero Mate**
Matt Leather
Cuir Matt



Discos



Discos



Bola



Bola



Semiesfera



Semiesfera



Cilindro



Cilindro



Cuadrado



Cuadrado



Tapón



Tapón

∅ 19 / 30 mm

Acero ■
Steel
Acier

■ Plata Mate
Matt Nickel
Nickel Satiné



Discos



Discos



Bola



Bola



Semiesfera



Semiesfera



Cilindro



Cilindro



Cuadrado



Cuadrado



Tapón



Tapón

∅ 19 / 30 mm

■ Blanco
White
Blanc



Omán



Cilindro



Kabul



Cuadrado



Copa



Tapón



Bola



Cono Combinado



Semiesfera

Ø 19 / 30 mm

Conjuntos completos VARADERO /
Complete sets VARADERO /
Kits complete VARADERO

T
Titanio
Titanium
Titanium

Omán



U	Ø 19 REF K.16918	Ø 30 REF K.16907	Ø 19/19 REF K.16919	Ø 30/19 REF K.16921		cm
1	72,86 €	100,81 €	130,92 €	158,59 €	16	150
1	80,50 €	112,29 €	146,19 €	177,70 €	20	200
1	101,02 €	137,95 €	179,81 €	216,34 €	26	250
1	108,72 €	149,57 €	195,22 €	235,66 €	30	300

Kabul



U	Ø 19 REF K.17018	Ø 30 REF K.17007	Ø 19/19 REF K.17019	Ø 30/19 REF K.17021		cm
1	72,91 €	100,81 €	131,01 €	158,63 €	16	150
1	80,55 €	112,29 €	146,28 €	177,74 €	20	200
1	101,06 €	137,95 €	179,91 €	216,38 €	26	250
1	108,77 €	149,57 €	195,32 €	235,70 €	30	300

Copa



U	Ø 19 REF K.16218	Ø 30 REF K.16207	Ø 19/19 REF K.16219	Ø 30/19 REF K.16221		cm
1	64,31 €	89,95 €	113,80 €	139,17 €	16	150
1	71,94 €	101,43 €	129,08 €	158,29 €	20	200
1	92,46 €	127,10 €	162,70 €	196,93 €	26	250
1	100,17 €	138,71 €	178,11 €	216,25 €	30	300

Bola



U	Ø 19 REF K.16018	Ø 30 REF K.16007	Ø 19/19 REF K.16019	Ø 30/19 REF K.16021		cm
1	65,46 €	84,71 €	116,10 €	135,08 €	16	150
1	78,15 €	96,19 €	131,38 €	154,19 €	20	200
1	93,61 €	121,85 €	165,00 €	192,83 €	26	250
1	101,32 €	133,47 €	180,41 €	212,15 €	30	300

Cilindro



U	Ø 19 REF K.16118	Ø 30 REF K.16107	Ø 19/19 REF K.16119	Ø 30/19 REF K.16121		cm
1	65,04 €	85,91 €	115,28 €	135,86 €	16	150
1	72,68 €	97,38 €	130,55 €	154,97 €	20	200
1	93,20 €	123,05 €	164,17 €	193,61 €	26	250
1	100,90 €	134,67 €	179,58 €	212,93 €	30	300

Tapón



U	Ø 19 REF K.16518	Ø 30 REF K.16507	Ø 19/19 REF K.16519	Ø 30/19 REF K.16521		cm
1	53,13 €	73,67 €	91,45 €	111,71 €	16	150
1	60,77 €	85,15 €	106,72 €	130,82 €	20	200
1	81,28 €	110,81 €	140,35 €	169,46 €	26	250
1	88,99 €	122,43 €	155,76 €	188,78 €	30	300

Conjuntos completos VARADERO /
Complete sets VARADERO /
Kits complete VARADERO

C CM PS A
 Cuero Brillo Leather Cuir
 Cuero Mate Matt leather Cuir matt
 Plata Mate Matt nickel Nickel Satiné
 Acero Steel Acier

Omán



U	Ø 19 REF K.16918	Ø 30 REF K.16907	Ø 19/19 REF K.16919	Ø 30/19 REF K.16921	Q	cm
1	65,37 €	94,88 €	126,68 €	151,41 €	16	150
1	72,17 €	104,79 €	140,30 €	168,13 €	20	200
1	89,36 €	128,27 €	172,64 €	204,38 €	26	250
1	96,23 €	138,32 €	186,39 €	221,31 €	30	300

Kabul



U	Ø 19 REF K.17018	Ø 30 REF K.17007	Ø 19/19 REF K.17019	Ø 30/19 REF K.17021	Q	cm
1	65,41 €	94,88 €	126,78 €	151,46 €	16	150
1	72,22 €	104,79 €	140,39 €	168,18 €	20	200
1	89,40 €	128,27 €	172,73 €	204,42 €	26	250
1	96,28 €	138,32 €	186,48 €	221,35 €	30	300

Tors



U	Ø 19 REF K.17618	Ø 30 REF K.17607	Ø 19/19 REF K.17619	Ø 30/19 REF K.17621	Q	cm
1	61,46 €	85,77 €	118,86 €	138,39 €	16	150
1	68,26 €	95,68 €	132,48 €	155,11 €	20	200
1	85,45 €	119,16 €	164,82 €	191,36 €	26	250
1	92,32 €	129,21 €	178,57 €	208,29 €	30	300

Truncado

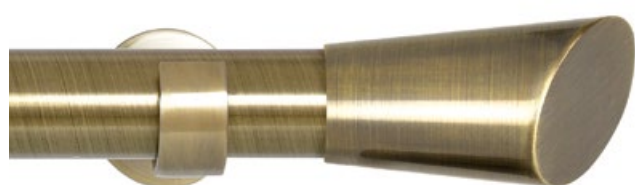

U	Ø 19 REF K.17718	Ø 30 REF K.17707	Ø 19/19 REF K.17719	Ø 30/19 REF K.17721	Q	cm
1	54,92 €	81,44 €	105,80 €	127,54 €	16	150
1	61,73 €	91,36 €	119,42 €	144,26 €	20	200
1	78,91 €	114,84 €	151,75 €	180,50 €	26	250
1	85,79 €	124,89 €	165,51 €	197,43 €	30	300

Discos



U	Ø 19 REF K.17818	Ø 30 REF K.17807	Ø 19/19 REF K.17819	Ø 30/19 REF K.17821	Q	cm
1	57,09 €	82,50 €	110,12 €	130,76 €	16	150
1	63,89 €	92,41 €	123,74 €	147,48 €	20	200
1	81,08 €	115,90 €	156,08 €	183,72 €	26	250
1	87,95 €	125,95 €	169,83 €	200,65 €	30	300

Copa Combinada



U	Ø 19 REF K.17918	Ø 30 REF K.17907	Ø 19/19 REF K.17919	Ø 30/19 REF K.17921	Q	cm
1	63,76 €	86,23 €	123,46 €	141,15 €	16	150
1	70,56 €	96,14 €	137,08 €	157,87 €	20	200
1	87,75 €	119,62 €	169,42 €	194,12 €	26	250
1	94,62 €	129,67 €	183,17 €	211,05 €	30	300

Conjuntos completos VARADERO /
Complete sets VARADERO /
Kits complete VARADERO



Copa

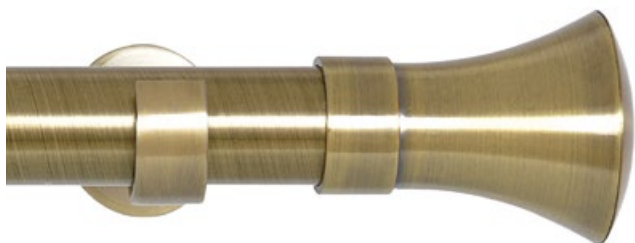

U	Ø 19 REF K.16218	Ø 30 REF K.16207	Ø 19/19 REF K.16219	Ø 30/19 REF K.16221	cm
1	56,81 €	84,02 €	109,57 €	132,00 €	16
1	63,62 €	93,93 €	123,19 €	148,72 €	20
1	80,80 €	117,42 €	155,53 €	184,97 €	26
1	87,68 €	127,47 €	169,28 €	201,89 €	30

Bola



U	Ø 19 REF K.16018	Ø 30 REF K.16007	Ø 19/19 REF K.16019	Ø 30/19 REF K.16021	cm
1	57,96 €	78,78 €	111,87 €	127,90 €	16
1	64,77 €	88,69 €	125,49 €	144,62 €	20
1	81,95 €	112,17 €	157,83 €	180,87 €	26
1	88,83 €	122,22 €	171,58 €	197,80 €	30

Semiesfera



U	Ø 19 REF K.16418	Ø 30 REF K.16407	Ø 19/19 REF K.16419	Ø 30/19 REF K.16421	cm
1	56,58 €	83,15 €	109,11 €	130,89 €	16
1	63,39 €	93,06 €	122,73 €	147,61 €	20
1	80,57 €	116,54 €	155,07 €	183,86 €	26
1	87,45 €	126,59 €	168,82 €	200,79 €	30

Cilindro



U	Ø 19 REF K.16118	Ø 30 REF K.16107	Ø 19/19 REF K.16119	Ø 30/19 REF K.16121	cm
1	57,55 €	79,97 €	111,04 €	128,69 €	16
1	64,35 €	89,88 €	124,66 €	145,41 €	20
1	81,54 €	113,37 €	157,00 €	181,65 €	26
1	88,41 €	123,42 €	170,75 €	198,58 €	30

Cuadrado



U	Ø 19 REF K.16318	Ø 30 REF K.16307	Ø 19/19 REF K.16319	Ø 30/19 REF K.16321	cm
1	57,87 €	79,42 €	111,69 €	128,46 €	16
1	64,68 €	89,33 €	125,30 €	145,18 €	20
1	81,86 €	112,82 €	157,64 €	181,42 €	26
1	88,73 €	122,87 €	171,40 €	198,35 €	30

Tapón



U	Ø 19 REF K.16518	Ø 30 REF K.16507	Ø 19/19 REF K.16519	Ø 30/19 REF K.16521	cm
1	45,63 €	67,74 €	87,22 €	104,54 €	16
1	52,44 €	77,65 €	100,83 €	121,26 €	20
1	69,62 €	101,13 €	133,17 €	157,50 €	26
1	76,50 €	111,18 €	146,92 €	174,43 €	30

Conjuntos completos VARADERO /
Complete sets VARADERO /
Kits complete VARADERO



Cono Combinado

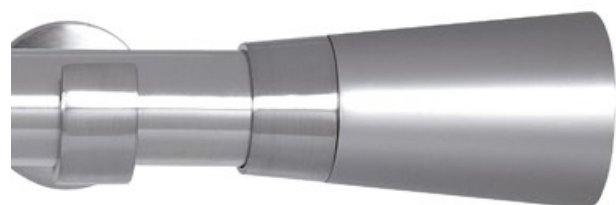

U	Ø 19 REF K.16618	Ø 30 REF K.16607	Ø 19/19 REF K.16619	Ø 30/19 REF K.16621	Q	cm
1	61,87 €	92,02 €	119,69 €	145,06 €	16	150
1	68,68 €	101,94 €	133,31 €	161,78 €	20	200
1	85,86 €	125,42 €	165,65 €	198,03 €	26	250
1	92,74 €	135,47 €	179,40 €	214,96 €	30	300

Conjuntos completos VARADERO /
Complete sets VARADERO /
Kits complete VARADERO

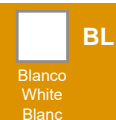

Omán



U	Ø 19 REF K.16918	Ø 30 REF K.16907	Ø 19/19 REF K.16919	Ø 30/19 REF K.16921	Q	cm
1	69,05 €	100,40 €	134,04 €	160,61 €	16	150
1	76,77 €	111,69 €	149,50 €	179,63 €	20	200
1	95,34 €	137,24 €	184,60 €	219,33 €	26	250
1	103,13 €	148,67 €	200,19 €	238,56 €	30	300

Kabul



U	Ø 19 REF K.17018	Ø 30 REF K.17007	Ø 19/19 REF K.17019	Ø 30/19 REF K.17021	Q	cm
1	69,09 €	100,40 €	134,14 €	160,66 €	16	150
1	76,82 €	111,69 €	149,59 €	179,68 €	20	200
1	95,38 €	137,24 €	184,69 €	219,37 €	26	250
1	103,18 €	148,67 €	200,28 €	238,60 €	30	300

Cono Combinado



U	Ø 19 REF K.16618	Ø 30 REF K.16607	Ø 19/19 REF K.16619	Ø 30/19 REF K.16621	Q	cm
1	65,55 €	97,54 €	127,05 €	154,26 €	16	150
1	73,28 €	108,84 €	142,51 €	173,28 €	20	200
1	91,84 €	134,39 €	177,61 €	212,98 €	26	250
1	99,64 €	145,82 €	193,20 €	232,21 €	30	300

Copa



U	Ø 19 REF K.16218	Ø 30 REF K.16207	Ø 19/19 REF K.16219	Ø 30/19 REF K.16221	Q	cm
1	60,49 €	89,54 €	116,93 €	141,20 €	16	150
1	68,22 €	100,83 €	132,39 €	160,22 €	20	200
1	86,78 €	126,39 €	167,49 €	199,92 €	26	250
1	94,58 €	137,82 €	183,08 €	219,14 €	30	300

Conjuntos completos VARADERO /
Complete sets VARADERO /
Kits complete VARADERO

BL
Blanco
White
Blanc

Bola



U	Ø 19 REF K.16018	Ø 30 REF K.16007	Ø 19/19 REF K.16019	Ø 30/19 REF K.16021	Light Bulb	cm
1	61,64 €	84,30 €	119,23 €	137,10 €	16	150
1	69,37 €	95,59 €	134,69 €	156,12 €	20	200
1	87,93 €	121,14 €	169,79 €	195,82 €	26	250
1	95,73 €	132,57 €	185,38 €	215,05 €	30	300

Semiesfera



U	Ø 19 REF K.16418	Ø 30 REF K.16407	Ø 19/19 REF K.16419	Ø 30/19 REF K.16421	Light Bulb	cm
1	60,26 €	88,67 €	116,47 €	140,09 €	16	150
1	67,99 €	99,96 €	131,93 €	159,11 €	20	200
1	86,55 €	125,51 €	167,03 €	198,81 €	26	250
1	94,35 €	136,94 €	182,62 €	218,04 €	30	300

Cilindro



U	Ø 19 REF K.16118	Ø 30 REF K.16107	Ø 19/19 REF K.16119	Ø 30/19 REF K.16121	Light Bulb	cm
1	61,23 €	85,49 €	118,40 €	137,89 €	16	150
1	68,95 €	96,78 €	133,86 €	156,91 €	20	200
1	87,52 €	122,34 €	168,96 €	196,60 €	26	250
1	95,31 €	133,77 €	184,55 €	215,83 €	30	300

Cuadrado



U	Ø 19 REF K.16318	Ø 30 REF K.16307	Ø 19/19 REF K.16319	Ø 30/19 REF K.16321	Light Bulb	cm
1	61,55 €	84,94 €	119,05 €	137,66 €	16	150
1	69,28 €	96,23 €	134,50 €	156,68 €	20	200
1	87,84 €	121,79 €	169,60 €	196,37 €	26	250
1	95,63 €	133,22 €	185,20 €	215,60 €	30	300

Tapón



U	Ø 19 REF K.16518	Ø 30 REF K.16507	Ø 19/19 REF K.16519	Ø 30/19 REF K.16521	Light Bulb	cm
1	49,04 €	73,26 €	94,02 €	113,46 €	16	150
1	56,76 €	84,55 €	109,48 €	132,48 €	20	200
1	75,33 €	110,10 €	144,58 €	172,18 €	26	250
1	83,12 €	121,53 €	160,17 €	191,41 €	30	300

Contenido del Kit / Kit components / Composants du Kit

🇪🇸 Conjuntos Sencillos : 2 terminales, 2 soportes, barra y anillas.
Los conjuntos de medida superior a 2 m se sirven con 3 soportes.

🇬🇧 Single sets : 2 finials, 2 brackets, pole & rings.
All sets with a length longer than 2 meters are supplied with 3 brackets.

🇫🇷 Kits simples : 2 embouts, 2 supports, tube et anneaux.
Tous les kits de mesures supérieures à 2 mètres contiennent 3 supports.

Tors

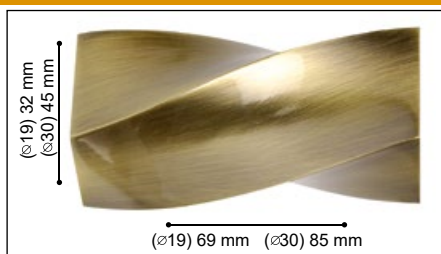

REF	∅	U	€	€	cm
A.2030A	19	10	8,72 €	10,03 €	
A.2030C	19	10	8,72 €	10,03 €	
A.2030CM	19	10	8,72 €	10,03 €	
A.2030PS	19	10	8,72 €	10,03 €	
A.2031A	30	10	12,34 €	14,19 €	
A.2031C	30	10	12,34 €	14,19 €	
A.2031CM	30	10	12,34 €	14,19 €	
A.2031PS	30	10	12,34 €	14,19 €	

Truncado

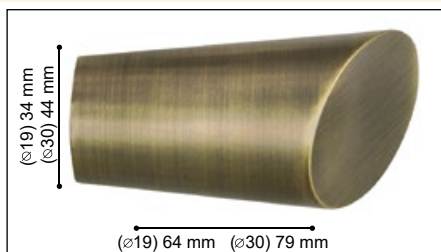

REF	∅	U	€	€	cm
A.2028A	19	10	5,88 €	6,76 €	
A.2028C	19	10	5,88 €	6,76 €	
A.2028CM	19	10	5,88 €	6,76 €	
A.2028PS	19	10	5,88 €	6,76 €	
A.2029A	30	10	10,46 €	12,03 €	
A.2029C	30	10	10,46 €	12,03 €	
A.2029CM	30	10	10,46 €	12,03 €	
A.2029PS	30	10	10,46 €	12,03 €	

Discos

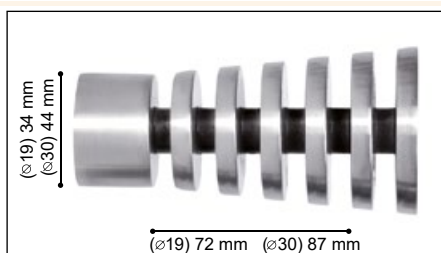

REF	∅	U	€	€	cm
A.2032A	19	10	6,82 €	7,84 €	
A.2032C	19	10	6,82 €	7,84 €	
A.2032CM	19	10	6,82 €	7,84 €	
A.2032PS	19	10	6,82 €	7,84 €	
A.2033A	30	10	10,92 €	12,56 €	
A.2033C	30	10	10,92 €	12,56 €	
A.2033CM	30	10	10,92 €	12,56 €	
A.2033PS	30	10	10,92 €	12,56 €	

Copa Combinada

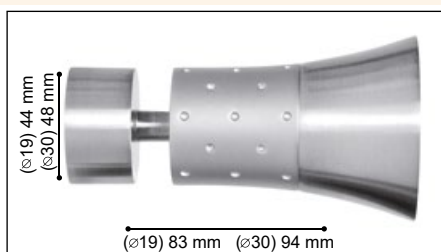

REF	∅	U	€	€	cm
A.2034APS	19	10	9,72 €	11,18 €	
A.2034CCM	19	10	9,72 €	11,18 €	
A.2035APS	30	10	12,54 €	14,42 €	
A.2035CCM	30	10	12,54 €	14,42 €	

Terminales / Finials / Embouts



Cono Combinado

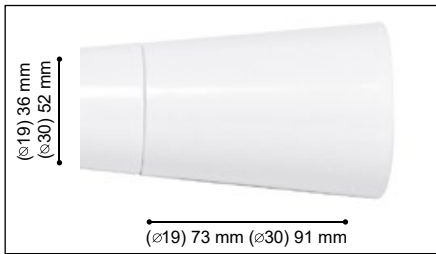

REF	∅	U	€	1	cm
A.2024PSPL	19	10	8,90 €	10,24 €	
A.2026CMLI	19	10	8,90 €	10,24 €	
A.2024BL	19	10	8,90 €	10,24 €	
A.2025PSPL	30	10	15,06 €	17,32 €	
A.2027CMLI	30	10	15,06 €	17,32 €	
A.2025BL	30	10	15,06 €	17,32 €	

Copa



REF	∅	U	€	1	cm
A.2013A	19	10	6,70 €	7,71 €	
A.2013BL	19	10	6,70 €	7,71 €	
A.2013C	19	10	6,70 €	7,71 €	
A.2013CM	19	10	6,70 €	7,71 €	
A.2013PS	19	10	6,70 €	7,71 €	
A.2013T	19	10	6,70 €	7,71 €	NEW
A.2016A	30	10	11,58 €	13,32 €	
A.2016BL	30	10	11,58 €	13,32 €	
A.2016C	30	10	11,58 €	13,32 €	
A.2016CM	30	10	11,58 €	13,32 €	
A.2016PS	30	10	11,58 €	13,32 €	
A.2016T	30	10	11,58 €	13,32 €	NEW

Bola



REF	∅	U	€	1	cm
A.2021A	19	10	7,20 €	8,28 €	
A.2021BL	19	10	7,20 €	8,28 €	
A.2021C	19	10	7,20 €	8,28 €	
A.2021CM	19	10	7,20 €	8,28 €	
A.2021PS	19	10	7,20 €	8,28 €	
A.2021T	19	10	7,20 €	8,28 €	NEW
A.2023A	30	10	9,30 €	10,70 €	
A.2023BL	30	10	9,30 €	10,70 €	
A.2023C	30	10	9,30 €	10,70 €	
A.2023CM	30	10	9,30 €	10,70 €	
A.2023PS	30	10	9,30 €	10,70 €	
A.2023T	30	10	9,30 €	10,70 €	NEW

Semiesfera

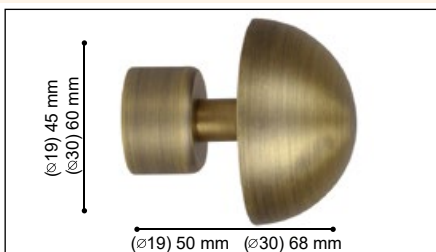

REF	∅	U	€	1	cm
A.2015A	19	10	6,60 €	7,59 €	
A.2015BL	19	10	6,60 €	7,59 €	
A.2015C	19	10	6,60 €	7,59 €	
A.2015CM	19	10	6,60 €	7,59 €	
A.2015PS	19	10	6,60 €	7,59 €	
A.2017A	30	10	11,20 €	12,88 €	
A.2017BL	30	10	11,20 €	12,88 €	
A.2017C	30	10	11,20 €	12,88 €	
A.2017CM	30	10	11,20 €	12,88 €	
A.2017PS	30	10	11,20 €	12,88 €	

Cilindro



REF	∅	U	€	€	cm
A.2012A	19	10	7,02 €	8,07 €	
A.2012BL	19	10	7,02 €	8,07 €	
A.2012C	19	10	7,02 €	8,07 €	
A.2012CM	19	10	7,02 €	8,07 €	
A.2012PS	19	10	7,02 €	8,07 €	
A.2012T	19	10	7,02 €	8,07 €	NEW
A.2018A	30	10	9,82 €	11,29 €	
A.2018BL	30	10	9,82 €	11,29 €	
A.2018C	30	10	9,82 €	11,29 €	
A.2018CM	30	10	9,82 €	11,29 €	
A.2018PS	30	10	9,82 €	11,29 €	
A.2018T	30	10	9,82 €	11,29 €	NEW

Cuadrado

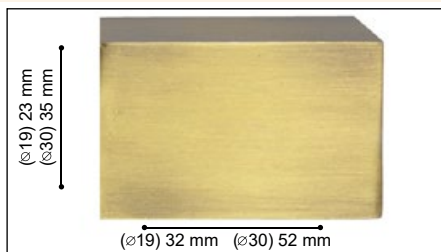

REF	∅	U	€	€	cm
A.2020A	19	10	7,16 €	8,23 €	
A.2020BL	19	10	7,16 €	8,23 €	
A.2020C	19	10	7,16 €	8,23 €	
A.2020CM	19	10	7,16 €	8,23 €	
A.2020PS	19	10	7,16 €	8,23 €	
A.2022A	30	10	9,58 €	11,02 €	
A.2022BL	30	10	9,58 €	11,02 €	
A.2022C	30	10	9,58 €	11,02 €	
A.2022CM	30	10	9,58 €	11,02 €	
A.2022PS	30	10	9,58 €	11,02 €	

Tapón

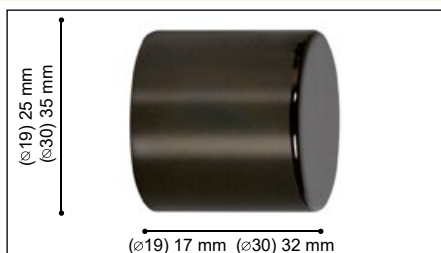

REF	∅	U	€	€	cm
A.6119A	19	10	1,84 €	2,12 €	
A.61199	19	10	1,72 €	1,98 €	
A.6119C	19	10	1,84 €	2,12 €	
A.6119CM	19	10	1,84 €	2,12 €	
A.6119PS	19	10	1,84 €	2,12 €	
A.6119T	19	10	1,84 €	2,12 €	NEW
A.6130A	30	10	4,50 €	5,18 €	
A.61309	30	10	4,50 €	5,18 €	
A.6130C	30	10	4,50 €	5,18 €	
A.6130CM	30	10	4,50 €	5,18 €	
A.6130PS	30	10	4,50 €	5,18 €	
A.6130T	30	10	4,50 €	5,18 €	NEW

Omán



REF	∅	U	€	€	cm
A.2036A	19	6	10,42 €	11,98 €	
A.2036BL	19	6	10,42 €	11,98 €	
A.2036C	19	6	10,42 €	11,98 €	
A.2036CM	19	6	10,42 €	11,98 €	
A.2036PS	19	6	10,42 €	11,98 €	
A.2036T	19	6	10,42 €	11,98 €	NEW
A.2037A	30	6	16,30 €	18,75 €	
A.2037BL	30	6	16,30 €	18,75 €	
A.2037C	30	6	16,30 €	18,75 €	
A.2037CM	30	6	16,30 €	18,75 €	
A.2037PS	30	6	16,30 €	18,75 €	
A.2037T	30	6	16,30 €	18,75 €	NEW

Terminales / Finials / Embouts



Kabul



REF	∅	U	€	1	cm
A.2038A	19	6	10,44 €	12,01 €	
A.2038BL	19	6	10,44 €	12,01 €	
A.2038C	19	6	10,44 €	12,01 €	
A.2038CM	19	6	10,44 €	12,01 €	
A.2038PS	19	6	10,44 €	12,01 €	
A.2038T	19	6	10,44 €	12,01 €	NEW
A.2039A	30	6	16,30 €	18,75 €	
A.2039BL	30	6	16,30 €	18,75 €	
A.2039C	30	6	16,30 €	18,75 €	
A.2039CM	30	6	16,30 €	18,75 €	
A.2039PS	30	6	16,30 €	18,75 €	
A.2039T	30	6	16,30 €	18,75 €	NEW

Accesorios / Accessories / Accessoires



Soporte Extensible
12,5 cm - 17,5 cm

Extendible
bracket /
Support
Extensible

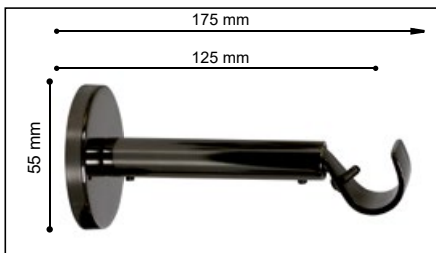

REF	∅	U	€	1	cm
A.4007A	19	10	9,52 €	10,95 €	
A.4007BL	19	10	9,52 €	10,95 €	
A.4007C	19	10	9,52 €	10,95 €	
A.4007CM	19	10	9,52 €	10,95 €	
A.4007PS	19	10	9,52 €	10,95 €	
A.4007T	19	10	9,52 €	10,95 €	NEW

Soporte Extensible
13,5 cm - 18,5 cm

Extendible
bracket /
Support
Extensible

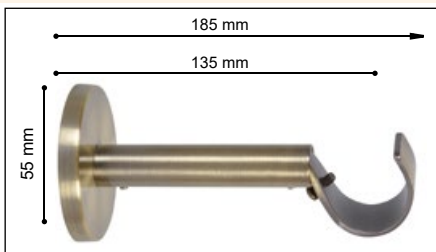

REF	∅	U	€	1	cm
A.4010A	30	10	10,20 €	11,73 €	
A.4010BL	30	10	10,20 €	11,73 €	
A.4010C	30	10	10,20 €	11,73 €	
A.4010CM	30	10	10,20 €	11,73 €	
A.4010PS	30	10	10,20 €	11,73 €	
A.4010T	30	10	10,20 €	11,73 €	NEW

Soporte Pared

Wall Bracket /
Support Mur

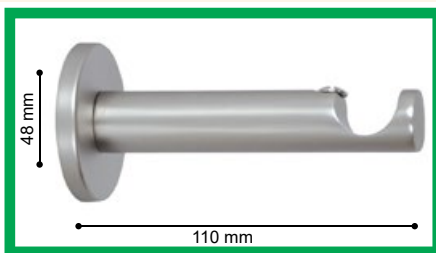

REF	∅	U	€	1	cm
A.4008A	19	10	7,70 €	8,86 €	
A.4008BL	19	10	7,70 €	8,86 €	
A.4008C	19	10	7,70 €	8,86 €	
A.4008CM	19	10	7,70 €	8,86 €	
A.4008PS	19	10	7,70 €	8,86 €	

* Soporte incluido en el Kit Sencillo / Bracket supplied in the Single Kit / Support fourni dans le Simple Kit.

Soporte Pared

Wall Bracket /
Support Bur

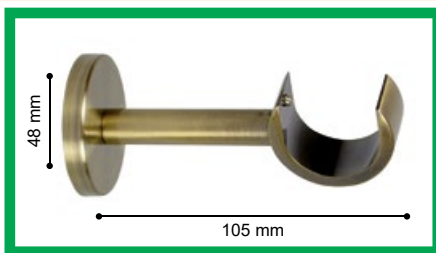

REF	∅	U	€	1	cm
A.4011A	30	10	10,34 €	11,89 €	
A.4011BL	30	10	10,34 €	11,89 €	
A.4011C	30	10	10,34 €	11,89 €	
A.4011CM	30	10	10,34 €	11,89 €	
A.4011PS	30	10	10,34 €	11,89 €	

* Soporte incluido en el Kit Sencillo / Bracket supplied in the Single Kit / Support fourni dans le Simple Kit.

Soporte
Doble Pared

Double Wall Bracket /
Support mur double

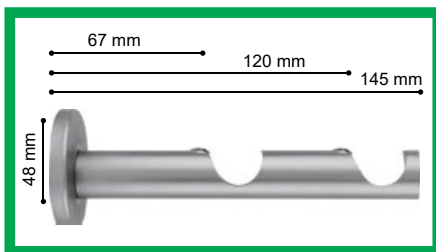

REF	∅	U	€	1	cm
A.4016A	19 / 19	10	13,64 €	15,69 €	
A.4016BL	19 / 19	10	13,64 €	15,69 €	
A.4016C	19 / 19	10	13,64 €	15,69 €	
A.4016CM	19 / 19	10	13,64 €	15,69 €	
A.4016PS	19 / 19	10	13,64 €	15,69 €	

* Soporte incluido en el Kit Doble / Bracket supplied in the Double Kit / Support fourni dans le Double Kit.

SopORTE Doble Pared
Double Wall Bracket / Support mur double

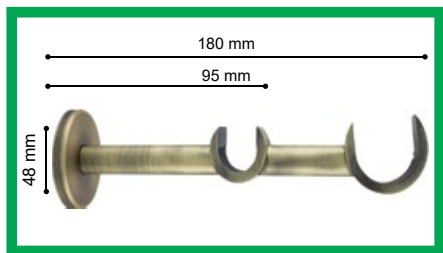

REF	∅	U	€	€	cm
A.4017A	30 / 19	10	14,20 €	16,33 €	
A.4017BL	30 / 19	10	14,20 €	16,33 €	
A.4017C	30 / 19	10	14,20 €	16,33 €	
A.4017CM	30 / 19	10	14,20 €	16,33 €	
A.4017PS	30 / 19	10	14,20 €	16,33 €	

* SopORTE incluido en el Kit Doble / Bracket supplied in the Double Kit / Support fourni dans le Double Kit.

SopORTE extensible
Extendible Bracket / Support Extensible

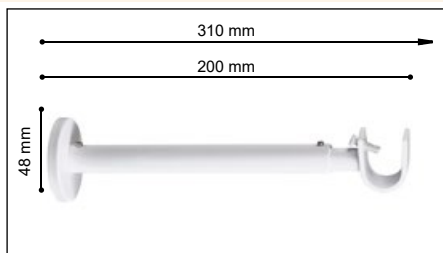

REF	∅	U	€	€	cm
A.4012A	19	10	14,20 €	16,33 €	
A.4012BL	19	10	14,20 €	16,33 €	
A.4012C	19	10	14,20 €	16,33 €	
A.4012CM	19	10	14,20 €	16,33 €	
A.4012PS	19	10	14,20 €	16,33 €	
A.4012T	19	10	14,20 €	16,33 €	

NEW

SopORTE extensible
Long Wall Bracket / Support Mur et Plafond

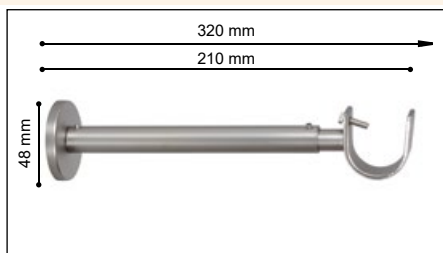

REF	∅	U	€	€	cm
A.4013A	30	10	14,20 €	16,33 €	
A.4013BL	30	10	14,20 €	16,33 €	
A.4013C	30	10	14,20 €	16,33 €	
A.4013CM	30	10	14,20 €	16,33 €	
A.4013PS	30	10	14,20 €	16,33 €	
A.4013T	30	10	14,20 €	16,33 €	

NEW

SopORTE Doble Pared Extensible
Extendible Double Wall Bracket / Support mur double extensible

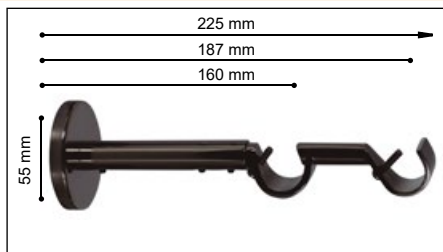

REF	∅	U	€	€	cm
A.4015A	19 / 19	10	12,60 €	14,49 €	
A.4015BL	19 / 19	10	12,60 €	14,49 €	
A.4015C	19 / 19	10	12,60 €	14,49 €	
A.4015CM	19 / 19	10	12,60 €	14,49 €	
A.4015PS	19 / 19	10	12,60 €	14,49 €	
A.4015T	19 / 19	10	12,60 €	14,49 €	

NEW

SopORTE Doble Pared Extensible
Extendible Double Wall Bracket / Support mur double extensible

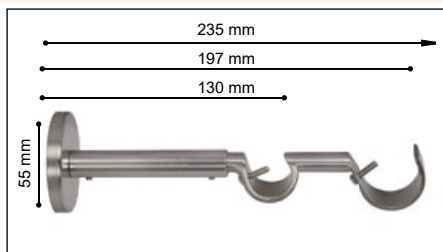

REF	∅	U	€	€	cm
A.4018A	30 / 19	10	13,16 €	15,13 €	
A.4018BL	30 / 19	10	13,16 €	15,13 €	
A.4018C	30 / 19	10	13,16 €	15,13 €	
A.4018CM	30 / 19	10	13,16 €	15,13 €	
A.4018PS	30 / 19	10	13,16 €	15,13 €	
A.4018T	30 / 19	10	13,16 €	15,13 €	

NEW

SopORTE Pared y Techo
Wall and Ceiling Bracket / Support Mur et Plafond



REF	∅	U	€	€	cm
A.4009A	19	10	6,60 €	7,59 €	
A.4009BL	19	10	6,60 €	7,59 €	
A.4009C	19	10	6,60 €	7,59 €	
A.4009CM	19	10	6,60 €	7,59 €	
A.4009PS	19	10	6,60 €	7,59 €	
A.4009T	19	10	6,60 €	7,59 €	
A.4014A	30	10	7,36 €	8,46 €	
A.4014BL	30	10	7,36 €	8,46 €	
A.4014C	30	10	7,36 €	8,46 €	
A.4014CM	30	10	7,36 €	8,46 €	
A.4014PS	30	10	7,36 €	8,46 €	
A.4014T	30	10	7,36 €	8,46 €	

NEW

NEW

SopORTE Refuerzo Extensible 15 cm - 20 cm
Reinforcing extendible brackets 15-20cms / Supports de renforcement extensibles 15-20cms

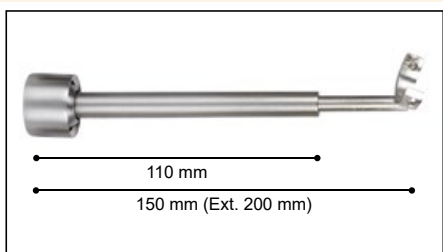

REF	∅	U	€	€	cm
N.502A		10	19,96 €	22,95 €	
N.502CC		10	19,96 €	22,95 €	
N.502PS		10	19,96 €	22,95 €	

* Compatible con SopORTes / Compatible with brackets / Compatible avec supports:
· A.4007A-C-CM-PS · A.4010A-C-CM-PS · A.4012A-C-CM-PS
· A.4013A-C-CM-PS · A.4017A-C-CM-PS

Soporte Lateral

Recess Bracket / Support Entre-Murs



REF	∅	U	€	€	cm
A.20419A	19	10	4,90 €	5,64 €	
A.20419BL	19	10	4,90 €	5,64 €	
A.20419C	19	10	4,90 €	5,64 €	
A.20419CM	19	10	4,90 €	5,64 €	
A.20419PS	19	10	4,90 €	5,64 €	
A.20419T	19	10	4,90 €	5,64 €	NEW
A.20430A	30	10	5,98 €	6,88 €	
A.20430BL	30	10	5,98 €	6,88 €	
A.20430C	30	10	5,98 €	6,88 €	
A.20430CM	30	10	5,98 €	6,88 €	
A.20430PS	30	10	5,98 €	6,88 €	
A.20430T	30	10	5,98 €	6,88 €	NEW

Anillas sin teflón

Rings without teflon / Anneaux sans teflon

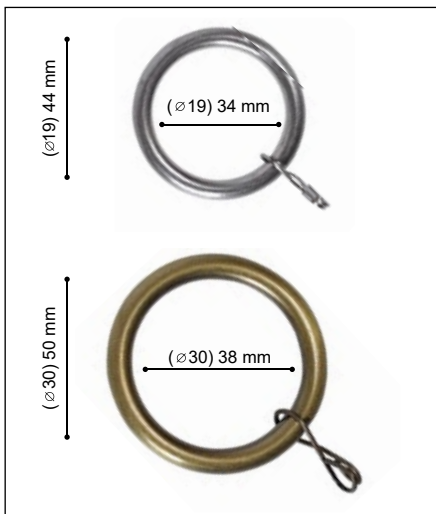

REF	∅	U	€	€	cm
A.3002A	19	100	0,62 €	0,71 €	
A.3002C	19	100	0,62 €	0,71 €	
A.3002CM	19	100	0,62 €	0,71 €	
A.3002PS	19	100	0,62 €	0,71 €	
A.3003A	30	100	0,68 €	0,78 €	
A.3003C	30	100	0,68 €	0,78 €	
A.3003CM	30	100	0,68 €	0,78 €	
A.3003PS	30	100	0,68 €	0,78 €	

Anillas con Teflón

Rings with teflon / Anneaux avec teflon

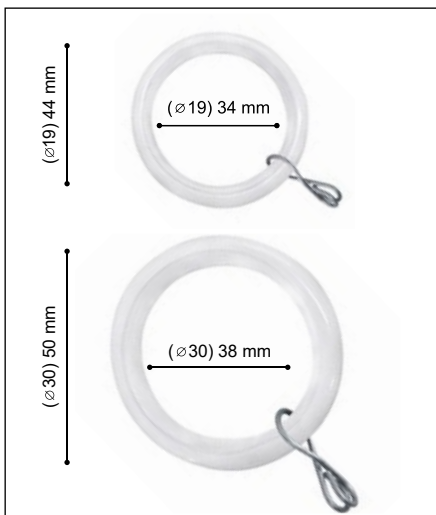

REF	∅	U	€	€	cm
A.3004A	19	100	0,82 €	0,94 €	
A.3004BL	19	100	0,82 €	0,94 €	
A.3004C	19	100	0,82 €	0,94 €	
A.3004CM	19	100	0,82 €	0,94 €	
A.3004PS	19	100	0,82 €	0,94 €	
A.3005A	30	100	0,98 €	1,13 €	
A.3005BL	30	100	0,98 €	1,13 €	
A.3005C	30	100	0,98 €	1,13 €	
A.3005CM	30	100	0,98 €	1,13 €	
A.3005PS	30	100	0,98 €	1,13 €	

Anilla Plana con teflón

Flat Teflon Rings / Anneaux Plats avec teflon

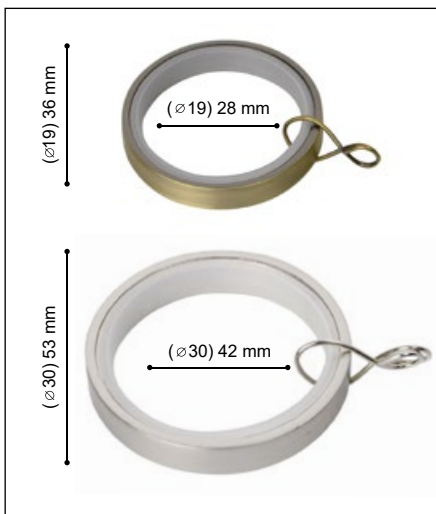

REF	∅	U	€	€	cm
A.3006A	19	100	0,80 €	0,92 €	
A.3006BL	19	100	0,80 €	0,92 €	
A.3006C	19	100	0,80 €	0,92 €	
A.3006CM	19	100	0,80 €	0,92 €	
A.3006PS	19	100	0,80 €	0,92 €	
A.3006T	19	100	0,80 €	0,92 €	NEW
A.3007A	30	100	1,02 €	1,17 €	
A.3007PS	30	100	1,02 €	1,17 €	
A.3007BL	30	100	1,02 €	1,17 €	
A.3007C	30	100	1,02 €	1,17 €	
A.3007CM	30	100	1,02 €	1,17 €	
A.3007T	30	100	1,02 €	1,17 €	NEW

Barra Acero

Steel Pole /
Tube Acier



REF	∅				
A.01915A	19	10	10,68 €	12,28 €	150
A.01920A	19	10	14,12 €	16,24 €	200
A.01925A	19	10	17,64 €	20,29 €	250
A.01930A	19	10	21,14 €	24,31 €	300
A.03015A	30	10	18,34 €	21,09 €	150
A.03020A	30	10	24,24 €	27,88 €	200
A.03025A	30	10	30,24 €	34,78 €	250
A.03030A	30	10	36,26 €	41,70 €	300

Barra Cuero

Leather Pole /
Tube Cuir



REF	∅				
A.01915C	19	10	10,68 €	12,28 €	150
A.01920C	19	10	14,12 €	16,24 €	200
A.01925C	19	10	17,64 €	20,29 €	250
A.01930C	19	10	21,14 €	24,31 €	300
A.03015C	30	10	18,34 €	21,09 €	150
A.03020C	30	10	24,24 €	27,88 €	200
A.03025C	30	10	30,24 €	34,78 €	250
A.03030C	30	10	36,26 €	41,70 €	300

Barra Cuero Mate

Matt Leather Pole /
Tube Cuir Matt



REF	∅				
A.01915CM	19	10	10,68 €	12,28 €	150
A.01920CM	19	10	14,12 €	16,24 €	200
A.01925CM	19	10	17,64 €	20,29 €	250
A.01930CM	19	10	21,14 €	24,31 €	300
A.03015CM	30	10	18,34 €	21,09 €	150
A.03020CM	30	10	24,24 €	27,88 €	200
A.03025CM	30	10	30,24 €	34,78 €	250
A.03030CM	30	10	36,26 €	41,70 €	300

Barra Plata Satinada

Matt Nickel Pole /
Tube Nickel Satiné

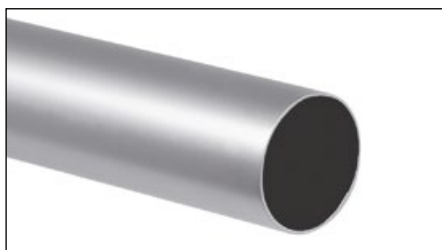

REF	∅				
A.01915PS	19	10	10,68 €	12,28 €	150
A.01920PS	19	10	14,12 €	16,24 €	200
A.01925PS	19	10	17,64 €	20,29 €	250
A.01930PS	19	10	21,14 €	24,31 €	300
A.03015PS	30	10	18,34 €	21,09 €	150
A.03020PS	30	10	24,24 €	27,88 €	200
A.03025PS	30	10	30,24 €	34,78 €	250
A.03030PS	30	10	36,26 €	41,70 €	300

Barra Blanca

White Pole /
Tube Blanc



REF	∅	U	€	€ ¹	cm
A.01915BL	19	10	10,68 €	12,28 €	150
A.01920BL	19	10	14,12 €	16,24 €	200
A.01925BL	19	10	17,64 €	20,29 €	250
A.01930BL	19	10	21,14 €	24,31 €	300
A.03015BL	30	10	18,34 €	21,09 €	150
A.03020BL	30	10	24,24 €	27,88 €	200
A.03025BL	30	10	30,24 €	34,78 €	250
A.03030BL	30	10	36,26 €	41,70 €	300

Barra Titanio

Titanium Pole /
Tube Titanium



REF	∅	U	€	€ ¹	cm
A.01915T	19	10	10,68 €	12,28 €	150
A.01920T	19	10	14,12 €	16,24 €	200
A.01925T	19	10	17,64 €	20,29 €	250
A.01930T	19	10	21,14 €	24,31 €	300
A.03015T	30	10	18,34 €	21,09 €	150
A.03020T	30	10	24,24 €	27,88 €	200
A.03025T	30	10	30,24 €	34,78 €	250
A.03030T	30	10	36,26 €	41,70 €	300

NEW

Expositor
VARADERO 1

VARADERO 1
Display Board /
Presentoir
VARADERO 1



REF	∅	U	€	€ ¹	cm
M.207		1		55,70 €	

Expositor
VARADERO 2

VARADERO 2
Display Board /
Presentoir
VARADERO 2



REF	∅	U	€	€ ¹	cm
M.215		1		55,70 €	

Expositor
VARADERO Mixto

VARADERO Mix
Display Board /
Presentoir
VARADERO Mix



REF	∅	U	€	€ ¹	cm
M.218		1		63,04 €	



ALTRAN[®]

CURTAIN DECORATION SYSTEMS

Barras Clásicas · Portavisillos

classic collections · net curtain rods / collections classiques



Barras Clásicas
Portavisillos



ALTRAN[®]
SISTEMAS PARA DECORAR CORTINAS



El latón seguramente no lo pondrías en tu casa pero...
si algún cliente te lo pide, lo puedes encontrar en Altran.
Soluciones y Estilos para cualquier proyecto.

LATÓN

COLECCIÓN DUERO, SÍMBOLO DE PRESTIGIO

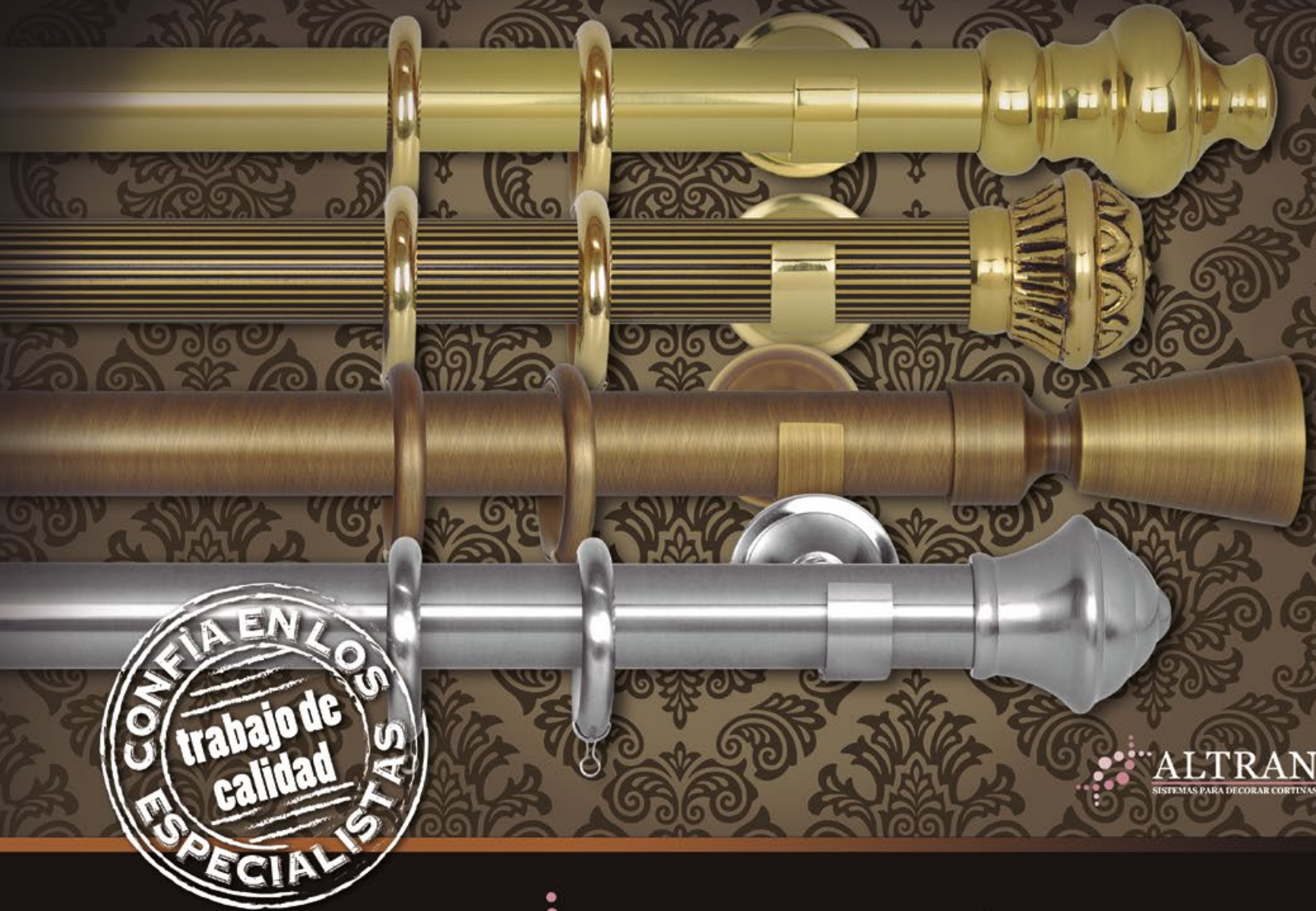

Barra de Cortina DUERO / Curtain Pole DUERO / Tringle a Rideux DUERO



Atlanta Pulido



Atlanta Cuero claro



Atlanta Acero

 La colección Duero está diseñada en latón. En ella se ha puesto la más alta garantía de calidad en su cuidadoso proceso de trabajo, en el acabado de los detalles, en la selección del mejor material y por supuesto en el diseño de sus terminales y soportes que permiten infinidad de soluciones decorativas. Siguiendo un estilo elegante, cálido, brillante con líneas puras y limpias, se convierte en la colección más formal y seria de Altran.

 Duero collection is made of brass that is the noblest material for poles. It has been designed and produced with the highest quality process taking special care on the finishing details using high quality materials. The design of its finials and supports allow countless decorative solutions. Following an elegant, warm, bright style with clean lines this collection becomes the more formal and serious collection of Altran.



Reino Pulido



Reino Cuero claro



Reino Acero

 La collection Duero est fabriquée en laiton qui est le matériel le plus noble pour la fabrication des tringles. Il a été conçu et fabriqué avec le processus de fabrication de la plus haute qualité en prenant un soin particulier sur les détails de finition en utilisant des matériaux de haute qualité. La conception de ses embouts et supports permettent d'innombrables solutions décoratives. Cette collection devant la collection plus formel et classique d'Altran avec avec son style élégant, chaleureux et lumineux avec lignes pures.



Londres Pulido



Londres Cuero claro



Londres Acero



Cairo Pulido



Cairo Cuero claro



Cairo Acero

Ø 19 / 30 mm

Barra de Cortina DUERO / Curtain Pole DUERO / Tringle a Rideux DUERO



Tope Pulido



Tope Cuero claro



Tope Acero



Piña Pátina



Verona Pátina



Sevilla Pátina



Chile Pátina

∅ 19 / 30 mm

Conjuntos completos DUERO /
Complete sets DUERO /
Kits complete DUERO

PU **CC** **A**
Pulido Polished Poli
Cuero Claro Light-leather Cuir clair
Acero Steel Acier

Atlanta



U	Ø 19 REF K.203PU	Ø 30 REF K.213PU	Ø 19/19 REF K.223PU	Ø 30/19 REF K.233PU	Q	cm
1	103,94 €	131,42 €	186,25 €	213,79 €	10	100
1	125,75 €	159,53 €	229,89 €	263,71 €	16	150
1	164,73 €	184,18 €	297,02 €	337,16 €	20	200
1	186,54 €	232,90 €	340,65 €	387,08 €	26	250
1	205,46 €	257,55 €	378,49 €	430,65 €	30	300
1	286,93 €	363,08 €	541,42 €	617,64 €	50	500



U	Ø 19 REF K.203CC	Ø 30 REF K.213CC	Ø 19/19 REF K.223CC	Ø 30/19 REF K.233CC	Q	cm
1	109,78 €	139,31 €	196,37 €	225,68 €	10	100
1	132,03 €	168,14 €	240,88 €	276,76 €	16	150
1	173,03 €	193,52 €	311,28 €	353,79 €	20	200
1	195,28 €	244,71 €	355,79 €	404,87 €	26	250
1	214,64 €	270,09 €	394,50 €	449,60 €	30	300
1	297,85 €	378,51 €	560,92 €	641,24 €	50	500



U	Ø 19 REF K.203A	Ø 30 REF K.213A	Ø 19/19 REF K.223A	Ø 30/19 REF K.233A	Q	cm
1	109,78 €	139,31 €	196,37 €	225,68 €	10	100
1	132,03 €	168,14 €	240,88 €	276,76 €	16	150
1	173,03 €	193,52 €	311,28 €	353,79 €	20	200
1	195,28 €	244,71 €	355,79 €	404,87 €	26	250
1	214,64 €	270,09 €	394,50 €	449,60 €	30	300
1	297,85 €	378,51 €	560,92 €	641,24 €	50	500

Reino

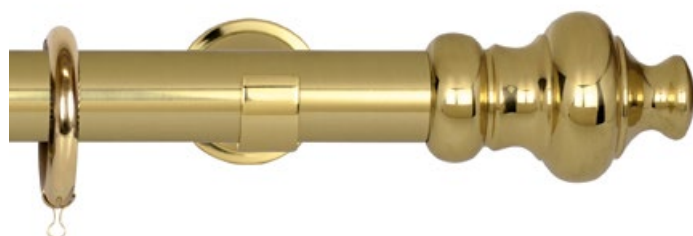

U	Ø 19 REF K.201PU	Ø 30 REF K.211PU	Ø 19/19 REF K.221PU	Ø 30/19 REF K.231PU	Q	cm
1	106,79 €	134,55 €	191,96 €	219,77 €	10	100
1	128,60 €	162,66 €	235,59 €	269,69 €	16	150
1	167,58 €	187,31 €	302,73 €	343,14 €	20	200
1	189,39 €	236,03 €	346,36 €	393,06 €	26	250
1	208,31 €	260,68 €	384,19 €	436,63 €	30	300
1	289,78 €	366,21 €	547,12 €	623,62 €	50	500



U	Ø 19 REF K.201CC	Ø 30 REF K.211CC	Ø 19/19 REF K.221CC	Ø 30/19 REF K.231CC	Q	cm
1	112,86 €	142,81 €	202,54 €	232,25 €	10	100
1	135,11 €	171,64 €	247,04 €	283,34 €	16	150
1	176,11 €	197,02 €	317,45 €	360,36 €	20	200
1	198,36 €	248,20 €	361,95 €	411,45 €	26	250
1	217,72 €	273,59 €	400,66 €	456,18 €	30	300
1	300,93 €	382,01 €	567,09 €	647,82 €	50	500



U	Ø 19 REF K.201A	Ø 30 REF K.211A	Ø 19/19 REF K.221A	Ø 30/19 REF K.231A	Q	cm
1	112,86 €	142,81 €	202,54 €	232,25 €	10	100
1	135,11 €	171,64 €	247,04 €	283,34 €	16	150
1	176,11 €	197,02 €	317,45 €	360,36 €	20	200
1	198,36 €	248,20 €	361,95 €	411,45 €	26	250
1	217,72 €	273,59 €	400,66 €	456,18 €	30	300
1	300,93 €	382,01 €	567,09 €	647,82 €	50	500

Conjuntos completos DUERO /
Complete sets DUERO /
Kits complete DUERO



Londres



U	Ø 19 REF K.202PU	Ø 30 REF K.212PU	Ø 19/19 REF K.222PU	Ø 30/19 REF K.232PU	cm
1	107,94 €	131,19 €	194,26 €	217,56 €	10
1	129,75 €	159,30 €	237,89 €	267,48 €	16
1	168,73 €	183,95 €	305,03 €	340,93 €	20
1	190,54 €	232,67 €	348,66 €	390,85 €	26
1	209,46 €	257,32 €	386,49 €	434,42 €	30
1	290,93 €	362,85 €	549,42 €	621,41 €	50



U	Ø 19 REF K.202CC	Ø 30 REF K.212CC	Ø 19/19 REF K.222CC	Ø 30/19 REF K.232CC	cm
1	114,15 €	139,13 €	205,11 €	229,86 €	10
1	136,40 €	167,96 €	249,62 €	280,95 €	16
1	177,40 €	193,34 €	320,02 €	357,97 €	20
1	199,65 €	244,52 €	364,53 €	409,06 €	26
1	219,01 €	269,91 €	403,24 €	453,79 €	30
1	302,22 €	378,33 €	569,66 €	645,43 €	50



U	Ø 19 REF K.202A	Ø 30 REF K.212A	Ø 19/19 REF K.222A	Ø 30/19 REF K.232A	cm
1	114,15 €	139,13 €	205,11 €	229,86 €	10
1	136,40 €	167,96 €	249,62 €	280,95 €	16
1	177,40 €	193,34 €	320,02 €	357,97 €	20
1	199,65 €	244,52 €	364,53 €	409,06 €	26
1	219,01 €	269,91 €	403,24 €	453,79 €	30
1	302,22 €	378,33 €	569,66 €	645,43 €	50

Cairo



U	Ø 19 REF K.204PU	Ø 30 REF K.214PU	Ø 19/19 REF K.224PU	Ø 30/19 REF K.234PU	cm
1	103,94 €	131,42 €	186,25 €	213,79 €	10
1	125,75 €	159,53 €	229,89 €	263,71 €	16
1	164,73 €	184,18 €	297,02 €	337,16 €	20
1	186,54 €	232,90 €	340,65 €	387,08 €	26
1	205,46 €	257,55 €	378,49 €	430,65 €	30
1	286,93 €	363,08 €	541,42 €	617,64 €	50



U	Ø 19 REF K.204CC	Ø 30 REF K.214CC	Ø 19/19 REF K.224CC	Ø 30/19 REF K.234CC	cm
1	109,78 €	139,31 €	196,37 €	225,68 €	10
1	132,03 €	168,14 €	240,88 €	276,76 €	16
1	173,03 €	193,52 €	311,28 €	353,79 €	20
1	195,28 €	244,71 €	355,79 €	404,87 €	26
1	214,64 €	270,09 €	394,50 €	449,60 €	30
1	297,85 €	378,51 €	560,92 €	641,24 €	50



U	Ø 19 REF K.204A	Ø 30 REF K.214A	Ø 19/19 REF K.224A	Ø 30/19 REF K.234A	cm
1	109,78 €	139,31 €	196,37 €	225,68 €	10
1	132,03 €	168,14 €	240,88 €	276,76 €	16
1	173,03 €	193,52 €	311,28 €	353,79 €	20
1	195,28 €	244,71 €	355,79 €	404,87 €	26
1	214,64 €	270,09 €	394,50 €	449,60 €	30
1	297,85 €	378,51 €	560,92 €	641,24 €	50

Conjuntos completos DUERO /
Complete sets DUERO /
Kits complete DUERO



Topo

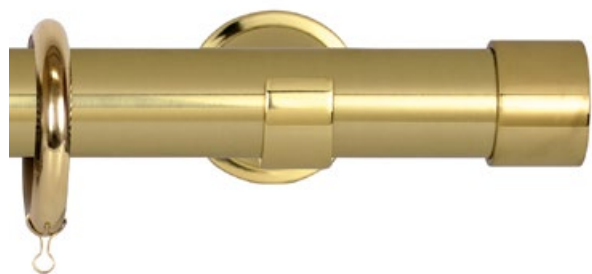

U	Ø 19 REF K.205PU	Ø 30 REF K.215PU	Ø 19/19 REF K.225PU	Ø 30/19 REF K.235PU	Q	cm
1	94,92 €	115,41 €	168,22 €	188,76 €	10	100
1	116,74 €	143,52 €	211,85 €	238,68 €	16	150
1	155,71 €	168,18 €	278,99 €	312,13 €	20	200
1	177,53 €	216,89 €	322,62 €	362,05 €	26	250
1	196,44 €	241,55 €	360,46 €	405,63 €	30	300
1	277,91 €	347,07 €	523,39 €	592,62 €	50	500



U	Ø 19 REF K.205CC	Ø 30 REF K.215CC	Ø 19/19 REF K.225CC	Ø 30/19 REF K.235CC	Q	cm
1	100,07 €	121,46 €	176,96 €	198,12 €	10	100
1	122,33 €	150,29 €	221,47 €	249,21 €	16	150
1	163,32 €	175,67 €	291,87 €	326,23 €	20	200
1	185,58 €	226,86 €	336,38 €	377,32 €	26	250
1	204,93 €	252,24 €	375,08 €	422,05 €	30	300
1	288,14 €	360,66 €	541,51 €	613,69 €	50	500



U	Ø 19 REF K.205A	Ø 30 REF K.215A	Ø 19/19 REF K.225A	Ø 30/19 REF K.235A	Q	cm
1	100,07 €	121,46 €	176,96 €	198,12 €	10	100
1	122,33 €	150,29 €	221,47 €	249,21 €	16	150
1	163,32 €	175,67 €	291,87 €	326,23 €	20	200
1	185,58 €	226,86 €	336,38 €	377,32 €	26	250
1	204,93 €	252,24 €	375,08 €	422,05 €	30	300
1	288,14 €	360,66 €	541,51 €	613,69 €	50	500

Piña



U	Ø 19 REF K.208PA	Ø 30 REF K.218PA	Ø 19/19 REF K.228PA	Ø 30/19 REF K.238PA	Q	cm
1	117,74 €	146,58 €	213,85 €	242,74 €	10	100
1	140,20 €	175,59 €	258,77 €	294,22 €	16	150
1	179,81 €	201,16 €	327,20 €	369,22 €	20	200
1	202,27 €	250,78 €	372,12 €	420,69 €	26	250
1	221,84 €	276,35 €	411,24 €	465,82 €	30	300
1	305,88 €	385,50 €	579,32 €	659,02 €	50	500

Verona



U	Ø 19 REF K.206PA	Ø 30 REF K.216PA	Ø 19/19 REF K.226PA	Ø 30/19 REF K.236PA	Q	cm
1	113,69 €	142,03 €	205,76 €	234,14 €	10	100
1	136,15 €	171,04 €	250,68 €	285,61 €	16	150
1	175,77 €	196,60 €	319,10 €	360,62 €	20	200
1	198,23 €	246,23 €	364,02 €	412,09 €	26	250
1	217,79 €	271,79 €	403,14 €	457,22 €	30	300
1	301,83 €	380,95 €	571,23 €	650,42 €	50	500

Sevilla

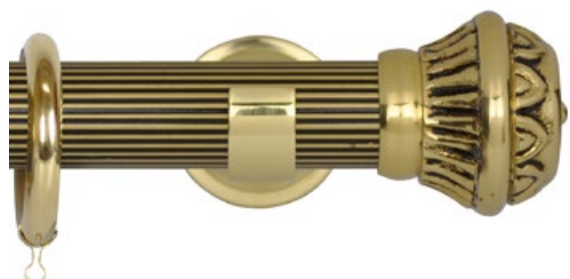

U	Ø 19 REF K.207PA	Ø 30 REF K.217PA	Ø 19/19 REF K.227PA	Ø 30/19 REF K.237PA	Q	cm
1	99,84 €	140,92 €	178,07 €	219,19 €	10	100
1	122,30 €	169,94 €	222,99 €	270,66 €	16	150
1	161,92 €	195,50 €	291,41 €	345,67 €	20	200
1	184,38 €	245,12 €	336,33 €	397,14 €	26	250
1	203,94 €	270,69 €	375,45 €	442,27 €	30	300
1	287,98 €	379,85 €	543,54 €	635,47 €	50	500

Conjuntos completos DUERO /
Complete sets DUERO /
Kits complete DUERO



Chile



U	Ø 19	Ø 30 REF K.219PA	Ø 19/19	Ø 30/19 REF K.239PA	cm
1	-	132,60 €	-	210,86 €	10
1	-	161,61 €	-	262,34 €	16
1	-	187,17 €	-	337,34 €	20
1	-	236,80 €	-	388,82 €	26
1	-	262,36 €	-	433,94 €	30
1	-	371,52 €	-	627,14 €	50

Contenido del Kit / Kit components / Composants du Kit

Conjuntos Sencillos : 2 terminales, 2 soportes, barra y anillas.
Los conjuntos de medida superior a 2 m se sirven con 3 soportes.

Single sets : 2 finials, 2 brackets, pole & rings.
All sets with a length longer than 2 meters are supplied with 3 brackets.

Kits simples : 2 embouts, 2 supports, tube et anneaux.
Tous les kits de mesures supérieures à 2 mètres contiennent 3 supports.

Terminales / Finials / Embouts

			PA	PU	CC	A	
Reino		REF	Ø	U	€	€	cm
		P.32119PU	19	10	11,28 €	12,97 €	
		P.32119CC	19	10	12,16 €	13,98 €	
		P.32119A	19	10	12,16 €	13,98 €	
		P.32130PU	30	10	17,64 €	20,29 €	
		P.32130CC	30	10	19,08 €	21,94 €	
		P.32130A	30	10	19,08 €	21,94 €	
Londres		REF	Ø	U	€	€	cm
		P.32219PU	19	10	11,78 €	13,55 €	
		P.32219CC	19	10	12,72 €	14,63 €	
		P.32219A	19	10	12,72 €	14,63 €	
		P.32230PU	30	10	16,18 €	18,61 €	
		P.32230CC	30	10	17,48 €	20,10 €	
		P.32230A	30	10	17,48 €	20,10 €	
Atlanta		REF	Ø	U	€	€	cm
		P.32319PU	19	10	10,04 €	11,55 €	
		P.32319CC	19	10	10,82 €	12,44 €	
		P.32319A	19	10	10,82 €	12,44 €	
		P.32330PU	30	10	16,28 €	18,72 €	
		P.32330CC	30	10	17,56 €	20,19 €	
		P.32330A	30	10	17,56 €	20,19 €	
Cairo		REF	Ø	U	€	€	cm
		P.32419PU	19	10	10,04 €	11,55 €	
		P.32419CC	19	10	10,82 €	12,44 €	
		P.32419A	19	10	10,82 €	12,44 €	
		P.32430PU	30	10	16,28 €	18,72 €	
		P.32430CC	30	10	17,56 €	20,19 €	
		P.32430A	30	10	17,56 €	20,19 €	
Tope		REF	Ø	U	€	€	cm
		P.32519PU	19	10	6,12 €	7,04 €	
		P.32519CC	19	10	6,60 €	7,59 €	
		P.32519A	19	10	6,60 €	7,59 €	
		P.32530PU	30	10	9,32 €	10,72 €	
		P.32530CC	30	10	9,80 €	11,27 €	
		P.32530A	30	10	9,80 €	11,27 €	

Terminales / Finials / Embouts



Verona



REF	Ø	U	€	€	cm
P.32619PA	19	10	13,72 €	15,78 €	
P.32630PA	30	10	20,10 €	23,12 €	

Sevilla

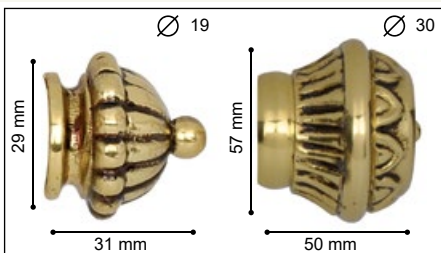

REF	Ø	U	€	€	cm
P.32719PA	19	10	7,70 €	8,86 €	
P.32730PA	30	10	19,62 €	22,56 €	

Piña



REF	Ø	U	€	€	cm
P.32819PA	19	10	15,48 €	17,80 €	
P.32830PA	30	10	22,08 €	25,39 €	

Chile



REF	Ø	U	€	€	cm
P.30029PA	30	10	16,00 €	18,40 €	

Accesorios / Accessories / Accessoires



Pulido (Materia: Latón)

Gold Polished
(Material: Brass) /
Doré
(Matériel: Laiton)



REF	Ø	U	€	€	cm
C.10216PU	16	25 m	20,58 €/m	23,67 €/m	
C.10219PU	19	25 m	22,82 €/m	26,24 €/m	
C.10230PU	30	25 m	30,88 €/m	35,51 €/m	

Cuero Claro (Materia: Latón)

Light Leather
(Material: Brass) /
Cuir Clair
(Matériel: Laiton)



REF	Ø	U	€	€	cm
C.10219CC	19	25 m	23,58 €/m	27,12 €/m	
C.10230CC	30	25 m	32,14 €/m	36,96 €/m	

Acero (Material: Acero Inoxidable)

Steel (Material:
stainless steel) /
Acier (Matériel:
acier inoxydable)



REF	Ø	U	€	€	cm
C.10219A	19	25 m	23,58 €/m	27,12 €/m	
C.10230A	30	25 m	32,14 €/m	36,96 €/m	

Pátina
(Materia: Latón)

Antique fluted
(Material:
stainless steel) /
Antique striée
(Matériel:
acier inoxydable)



REF	∅	U	€	€ ¹	cm
C.10119PA	19	25 m	23,94 €/m	27,53 €/m	
C.10130PA	30	25 m	32,46 €/m	37,33 €/m	

Soporte frente

Bracket Wall /
Support mur

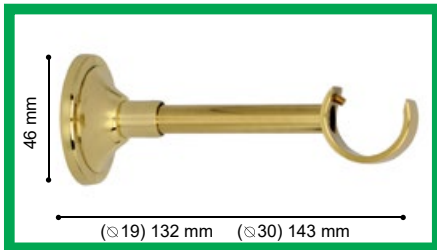

REF	∅	U	€	€ ¹	cm
N.50019PU	19	10	17,44 €	20,06 €	
N.50019CC	19	10	18,82 €	21,64 €	
N.50019A	19	10	18,82 €	21,64 €	
N.50030PU	30	10	17,92 €	20,61 €	
N.50030CC	30	10	19,44 €	22,36 €	
N.50030A	30	10	19,44 €	22,36 €	

* Soporte incluido en el Kit Sencillo /
Bracket supplied in the Single Kit / Support fourni dans le Simple Kit.

Soporte Largo

Bracket Wall Long /
Support mur largo



REF	∅	U	€	€ ¹	cm
N.50219PU	19	10	18,64 €	21,44 €	
N.50219CC	19	10	20,10 €	23,12 €	
N.50219A	19	10	20,10 €	23,12 €	
N.50230PU	30	10	20,10 €	23,12 €	
N.50230CC	30	10	21,72 €	24,98 €	
N.50230A	30	10	21,72 €	24,98 €	

Soporte Techo

Bracket Ceiling /
Support Plafond



REF	∅	U	€	€ ¹	cm
N.50119PU	19	10	18,16 €	20,88 €	
N.50119CC	19	10	20,44 €	23,51 €	
N.50119A	19	10	20,44 €	23,51 €	
N.50130PU	30	10	21,42 €	24,63 €	
N.50130CC	30	10	23,14 €	26,61 €	
N.50130A	30	10	23,14 €	26,61 €	

Soporte frente doble

Bracket
Wall Double /
Support
Mur Double

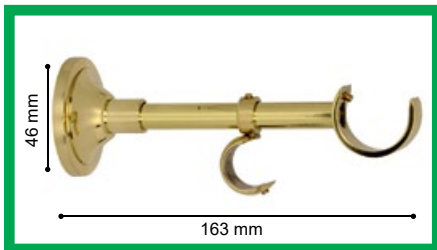

REF	∅	U	€	€ ¹	cm
O.51119PU	19/19	10	25,48 €	29,30 €	
O.51119CC	19/19	10	27,56 €	31,69 €	
O.51119A	19/19	10	27,56 €	31,69 €	
O.51319PU	30/19	10	25,98 €	29,88 €	
O.51319CC	30/19	10	28,08 €	32,29 €	
O.51319A	30/19	10	28,08 €	32,29 €	

* Soporte incluido en el Kit Doble /
Bracket supplied in the Double Kit / Support fourni dans le Double Kit.

Soporte Auxiliar para Barras

Curtain Pole
Auxiliary Bracket /
Support
complémentaire



REF	∅	U	€	€ ¹	cm
V.19PU	19	10	8,72 €	10,03 €	
V.19CC	19	10	8,82 €	10,14 €	
V.19A	19	10	8,82 €	10,14 €	

NEW

Terminales / Finials / Embouts



<p>Soporte Techo Doble Bracket Ceiling Double / Support Plafond Double</p>		<table border="1"> <thead> <tr> <th>REF</th> <th>∅</th> <th>U</th> <th>€</th> <th>€</th> <th>cm</th> </tr> </thead> <tbody> <tr><td>O.52119PU</td><td>19/19</td><td>10</td><td>25,50 €</td><td>29,33 €</td><td></td></tr> <tr><td>O.52119CC</td><td>19/19</td><td>10</td><td>27,54 €</td><td>31,67 €</td><td></td></tr> <tr><td>O.52119A</td><td>19/19</td><td>10</td><td>27,54 €</td><td>31,67 €</td><td></td></tr> <tr><td>O.52319PU</td><td>30/19</td><td>10</td><td>25,98 €</td><td>29,88 €</td><td></td></tr> <tr><td>O.52319CC</td><td>30/19</td><td>10</td><td>28,08 €</td><td>32,29 €</td><td></td></tr> <tr><td>O.52319A</td><td>30/19</td><td>10</td><td>28,08 €</td><td>32,29 €</td><td></td></tr> </tbody> </table>	REF	∅	U	€	€	cm	O.52119PU	19/19	10	25,50 €	29,33 €		O.52119CC	19/19	10	27,54 €	31,67 €		O.52119A	19/19	10	27,54 €	31,67 €		O.52319PU	30/19	10	25,98 €	29,88 €		O.52319CC	30/19	10	28,08 €	32,29 €		O.52319A	30/19	10	28,08 €	32,29 €	
REF	∅	U	€	€	cm																																							
O.52119PU	19/19	10	25,50 €	29,33 €																																								
O.52119CC	19/19	10	27,54 €	31,67 €																																								
O.52119A	19/19	10	27,54 €	31,67 €																																								
O.52319PU	30/19	10	25,98 €	29,88 €																																								
O.52319CC	30/19	10	28,08 €	32,29 €																																								
O.52319A	30/19	10	28,08 €	32,29 €																																								
<p>Soporte Refuerzo Extensible 15 cm - 20 cm Reinforcing extendible brackets 15-20cms / Supports de renforcement extensibles 15-20cms</p>		<table border="1"> <thead> <tr> <th>REF</th> <th>∅</th> <th>U</th> <th>€</th> <th>€</th> <th>cm</th> </tr> </thead> <tbody> <tr><td>N.502PU</td><td></td><td>10</td><td>19,44 €</td><td>22,36 €</td><td></td></tr> <tr><td>N.502CC</td><td></td><td>10</td><td>19,96 €</td><td>22,95 €</td><td></td></tr> <tr><td>N.502A</td><td></td><td>10</td><td>19,96 €</td><td>22,95 €</td><td></td></tr> </tbody> </table> <p>* Compatible with Soportes / Compatible with brackets / Compatible avec supports: · N.50019PU · N.50019CC · N.50019A · N.50030PU · N.50030CC · N.50030A · O.51119PU · O.51119CC · O.51119A · O.51130PU · O.51130CC · O.51130A</p>	REF	∅	U	€	€	cm	N.502PU		10	19,44 €	22,36 €		N.502CC		10	19,96 €	22,95 €		N.502A		10	19,96 €	22,95 €																			
REF	∅	U	€	€	cm																																							
N.502PU		10	19,44 €	22,36 €																																								
N.502CC		10	19,96 €	22,95 €																																								
N.502A		10	19,96 €	22,95 €																																								
<p>Soporte Dintel Recess bracket / Support naissance</p>		<table border="1"> <thead> <tr> <th>REF</th> <th>∅</th> <th>U</th> <th>€</th> <th>€</th> <th>cm</th> </tr> </thead> <tbody> <tr><td>N.50419PU</td><td>19</td><td>10</td><td>8,58 €</td><td>9,87 €</td><td></td></tr> <tr><td>N.50419CC</td><td>19</td><td>10</td><td>9,28 €</td><td>10,67 €</td><td></td></tr> <tr><td>N.50419A</td><td>19</td><td>10</td><td>9,28 €</td><td>10,67 €</td><td></td></tr> <tr><td>N.50430PU</td><td>30</td><td>10</td><td>11,76 €</td><td>13,52 €</td><td></td></tr> <tr><td>N.50430CC</td><td>30</td><td>10</td><td>12,72 €</td><td>14,63 €</td><td></td></tr> <tr><td>N.50430A</td><td>30</td><td>10</td><td>12,72 €</td><td>14,63 €</td><td></td></tr> </tbody> </table>	REF	∅	U	€	€	cm	N.50419PU	19	10	8,58 €	9,87 €		N.50419CC	19	10	9,28 €	10,67 €		N.50419A	19	10	9,28 €	10,67 €		N.50430PU	30	10	11,76 €	13,52 €		N.50430CC	30	10	12,72 €	14,63 €		N.50430A	30	10	12,72 €	14,63 €	
REF	∅	U	€	€	cm																																							
N.50419PU	19	10	8,58 €	9,87 €																																								
N.50419CC	19	10	9,28 €	10,67 €																																								
N.50419A	19	10	9,28 €	10,67 €																																								
N.50430PU	30	10	11,76 €	13,52 €																																								
N.50430CC	30	10	12,72 €	14,63 €																																								
N.50430A	30	10	12,72 €	14,63 €																																								
<p>Codo Articulado Articulated Elbow / Coude articulé</p>		<table border="1"> <thead> <tr> <th>REF</th> <th>∅</th> <th>U</th> <th>€</th> <th>€</th> <th>cm</th> </tr> </thead> <tbody> <tr><td>H.519PU</td><td>19</td><td>10</td><td>18,40 €</td><td>21,16 €</td><td></td></tr> <tr><td>H.519CC</td><td>19</td><td>10</td><td>19,88 €</td><td>22,86 €</td><td></td></tr> <tr><td>H.519A</td><td>19</td><td>10</td><td>19,88 €</td><td>22,86 €</td><td></td></tr> <tr><td>H.530PU</td><td>30</td><td>10</td><td>25,00 €</td><td>28,75 €</td><td></td></tr> <tr><td>H.530CC</td><td>30</td><td>10</td><td>27,02 €</td><td>31,07 €</td><td></td></tr> <tr><td>H.530A</td><td>30</td><td>10</td><td>27,02 €</td><td>31,07 €</td><td></td></tr> </tbody> </table>	REF	∅	U	€	€	cm	H.519PU	19	10	18,40 €	21,16 €		H.519CC	19	10	19,88 €	22,86 €		H.519A	19	10	19,88 €	22,86 €		H.530PU	30	10	25,00 €	28,75 €		H.530CC	30	10	27,02 €	31,07 €		H.530A	30	10	27,02 €	31,07 €	
REF	∅	U	€	€	cm																																							
H.519PU	19	10	18,40 €	21,16 €																																								
H.519CC	19	10	19,88 €	22,86 €																																								
H.519A	19	10	19,88 €	22,86 €																																								
H.530PU	30	10	25,00 €	28,75 €																																								
H.530CC	30	10	27,02 €	31,07 €																																								
H.530A	30	10	27,02 €	31,07 €																																								
<p>Rosetón Perlas Rosette / Rosace</p>		<table border="1"> <thead> <tr> <th>REF</th> <th>∅</th> <th>U</th> <th>€</th> <th>€</th> <th>cm</th> </tr> </thead> <tbody> <tr><td>R.1181PU</td><td></td><td>10</td><td>5,18 €</td><td>5,96 €</td><td>60</td></tr> <tr><td>R.1181CC</td><td></td><td>10</td><td>5,64 €</td><td>6,49 €</td><td>60</td></tr> <tr><td>R.1181A</td><td></td><td>10</td><td>5,64 €</td><td>6,49 €</td><td>60</td></tr> <tr><td>R.1181PA</td><td></td><td>10</td><td>5,84 €</td><td>6,72 €</td><td>60</td></tr> </tbody> </table>	REF	∅	U	€	€	cm	R.1181PU		10	5,18 €	5,96 €	60	R.1181CC		10	5,64 €	6,49 €	60	R.1181A		10	5,64 €	6,49 €	60	R.1181PA		10	5,84 €	6,72 €	60												
REF	∅	U	€	€	cm																																							
R.1181PU		10	5,18 €	5,96 €	60																																							
R.1181CC		10	5,64 €	6,49 €	60																																							
R.1181A		10	5,64 €	6,49 €	60																																							
R.1181PA		10	5,84 €	6,72 €	60																																							
<p>Rosetón Liso Rosette / Rosace</p>		<table border="1"> <thead> <tr> <th>REF</th> <th>∅</th> <th>U</th> <th>€</th> <th>€</th> <th>cm</th> </tr> </thead> <tbody> <tr><td>R.1157PU</td><td></td><td>10</td><td>4,72 €</td><td>5,43 €</td><td>60</td></tr> <tr><td>R.1157CC</td><td></td><td>10</td><td>5,02 €</td><td>5,77 €</td><td>60</td></tr> <tr><td>R.1157A</td><td></td><td>10</td><td>5,02 €</td><td>5,77 €</td><td>60</td></tr> </tbody> </table>	REF	∅	U	€	€	cm	R.1157PU		10	4,72 €	5,43 €	60	R.1157CC		10	5,02 €	5,77 €	60	R.1157A		10	5,02 €	5,77 €	60																		
REF	∅	U	€	€	cm																																							
R.1157PU		10	4,72 €	5,43 €	60																																							
R.1157CC		10	5,02 €	5,77 €	60																																							
R.1157A		10	5,02 €	5,77 €	60																																							
<p>Rosetón Italiano Rosette / Rosace</p>		<table border="1"> <thead> <tr> <th>REF</th> <th>∅</th> <th>U</th> <th>€</th> <th>€</th> <th>cm</th> </tr> </thead> <tbody> <tr><td>R.1147PA</td><td></td><td>10</td><td>6,36 €</td><td>7,31 €</td><td>60</td></tr> </tbody> </table>	REF	∅	U	€	€	cm	R.1147PA		10	6,36 €	7,31 €	60																														
REF	∅	U	€	€	cm																																							
R.1147PA		10	6,36 €	7,31 €	60																																							
<p>Prolongador Spindle / Prolongateur</p>		<table border="1"> <thead> <tr> <th>REF</th> <th>∅</th> <th>U</th> <th>€</th> <th>€</th> <th>cm</th> </tr> </thead> <tbody> <tr><td>R.1166PU</td><td></td><td>10</td><td>4,50 €</td><td>5,18 €</td><td>100</td></tr> <tr><td>R.1166CC</td><td></td><td>10</td><td>4,88 €</td><td>5,61 €</td><td>100</td></tr> <tr><td>R.1166A</td><td></td><td>10</td><td>4,88 €</td><td>5,61 €</td><td>100</td></tr> <tr><td>R.1167PU</td><td></td><td>10</td><td>6,16 €</td><td>7,08 €</td><td>150</td></tr> <tr><td>R.1167CC</td><td></td><td>10</td><td>6,64 €</td><td>7,64 €</td><td>150</td></tr> <tr><td>R.1167A</td><td></td><td>10</td><td>6,64 €</td><td>7,64 €</td><td>150</td></tr> </tbody> </table>	REF	∅	U	€	€	cm	R.1166PU		10	4,50 €	5,18 €	100	R.1166CC		10	4,88 €	5,61 €	100	R.1166A		10	4,88 €	5,61 €	100	R.1167PU		10	6,16 €	7,08 €	150	R.1167CC		10	6,64 €	7,64 €	150	R.1167A		10	6,64 €	7,64 €	150
REF	∅	U	€	€	cm																																							
R.1166PU		10	4,50 €	5,18 €	100																																							
R.1166CC		10	4,88 €	5,61 €	100																																							
R.1166A		10	4,88 €	5,61 €	100																																							
R.1167PU		10	6,16 €	7,08 €	150																																							
R.1167CC		10	6,64 €	7,64 €	150																																							
R.1167A		10	6,64 €	7,64 €	150																																							

Abrazadera
Holder /
Embrasse

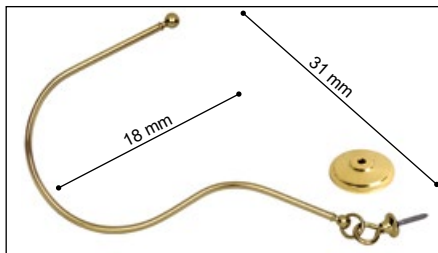

REF	∅	U	€	€	cm
R.1220PU		10	30,10 €	34,62 €	
R.1220CC		10	32,52 €	37,40 €	
R.1220A		10	32,52 €	37,40 €	

Anillas con teflón
Rings with teflon /
Anneaux avec teflon

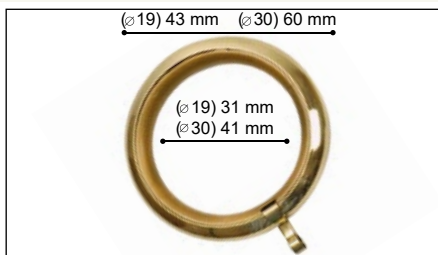

REF	∅	U	€	€	cm
H.20019PU	19	50	1,26 €	1,45 €	
H.20019CC	19	50	1,26 €	1,45 €	
H.20019A	19	50	1,26 €	1,45 €	
H.20030PU	30	50	1,50 €	1,73 €	
H.20030CC	30	50	1,50 €	1,73 €	
H.20030A	30	50	1,50 €	1,73 €	

Gancho
Hook /
Gond



REF	∅	U	€	€	cm
R.1001LA		50	1,74 €	2,00 €	
R.1001AB		50	1,74 €	2,00 €	
R.1001PL		50	1,74 €	2,00 €	
R.1001PS		50	1,74 €	2,00 €	
R.1001BL		50	1,50 €	1,73 €	
R.1002LA		50	1,88 €	2,16 €	
R.1002AB		50	1,88 €	2,16 €	
R.1002PL		50	1,88 €	2,16 €	
R.1002PS		50	1,88 €	2,16 €	
R.1002BL		50	1,66 €	1,91 €	

Tirador
Wand /
Bâiton



REF	∅	U	€	€	cm
L.3100PU		10	24,30 €	27,95 €	100
L.3100CC		10	26,30 €	30,25 €	100
L.3100A		10	26,30 €	30,25 €	100

Expositor
DUERO

DUERO
Display Board /
Presentoir DUERO



REF	∅	U	€	€	cm
M.210		1		120,32 €	

ESCALERA Ø 16

Conjunto Completo ESCALERA /
Complete sets STAIRCASE /
Kits complets pour ESCALIER



Escalera / Staircase / Escalier



REF	Ø			
K.101100PU	16	1	60,38 €	100
K.101150PU	16	1	72,21 €	150

Accesorios / Accessories / Accessoires



Soporte

Bracket /
Support

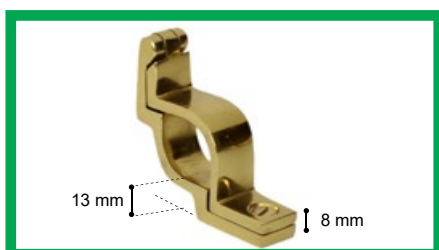

REF	Ø				
N.50117	16	25	9,36 €	10,76 €	

* Soporte incluido en el kit / Bracket supplied in the kit / Support fourni dans le kit.

Barra lisa

Brass Pole /
Barre laiton



REF	Ø				
C.10216PU	16	25 m	20,58 €/m	23,67 €/m	500

* Medida máxima de la barra sin empalmes 5m
Maximum length of the pole without splice 5m / Longueur maximum tringle sans raccord 5m

Piña latón

Solid brass finials /
Embouts en laiton
massif



REF	Ø				
P.30716	16	25	6,60 €	7,59 €	

Colaboramos con RTVE decorando con nuestras Barras de Escalera la Serie TRAICIÓN



Accesorios para MUSEO /
MUSEUM Cords Accessories /
Accessoires de Cordon pour MUSÉE



Peana de latón pulido 1m. / Solid brass barrier rope stand 1m. Goldpolished / Potelet Laiton massif 1m. or poli

Peana de 1m
latón pulido

Solid brass barrier
rope stand 1m Gold
polished /
Potelet Laiton
massif 1m or poli



REF	∅	U	€	€	cm
R.19PU		1		210,54 €	100

Terminal con anilla
latón

Solid Brass Endcap
with ring /
Terminaison avec
anneau laiton massif



REF	∅	U	€	€	cm
R.1173		10	14,22 €	16,35 €	

* Terminal incluido en el kit / Finial supplied in the kit / Enbout fourni dans le kit.

Gancho latón

Solid brass Hook /
Gond en laiton massif



REF	∅	U	€	€	cm
R.1172		10	9,46 €	10,88 €	

Cordón

Barrier Rope /
Barrier



REF	∅	U	€	€	cm
D.1701		1		18,34 €/m	100
D.1703		1		18,34 €/m	100
D.1708		1		18,34 €/m	100

D.1701 - Crudo / Canvas Colour / Couleur Écru.

D.1703 - Oro / Gold / Or

D.1708 - Granate / Burgundy / Bordeaux



ALTRAN[®]

CURTAIN DECORATION SYSTEMS



Coliseum



Gajos

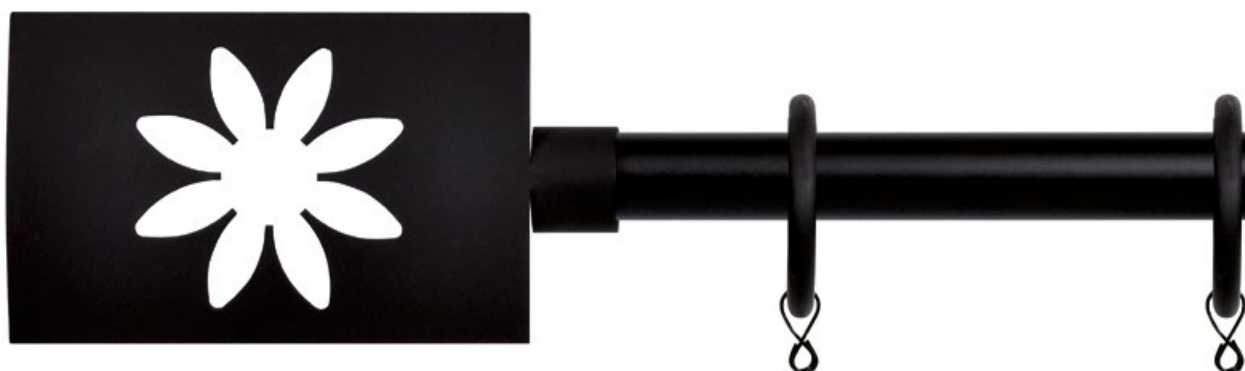

Estrella Plana



Onda Plana

Las colecciones de hierro forjado han estado siempre presentes en el mercado. Ahora es el momento de modernizarlas, empleando infinidad de soportes que cubren múltiples ambientes. Además su riqueza en terminales, permite numerosas combinaciones acordes a la decoración de cualquier habitación en estilo rústico.

Wrought iron collections have always been present in the market. Now is the time to modernize it including different option for supports for all kind of ambientes. Besides its range of finials, provided numerous combinations that match the decoration of any room in rustic style.

Les collections en fer forgé ont toujours été présents sur le marché. Il est maintenant temps de le moderniser avec les options différents de supports pour toutes sortes de environnements. Outre sa gamme d'embouts offres de nombreuses combinaisons pour la décoration avec un style rustique.



Bola Negro



Tope Negro



Báculo Marfil - Oro



Terra Negro - Oro



Feria Negro - Óxido

Ø 19 / 30 mm



Bola Negro



Tapón Negro



Palmera Marfil - Oro



Trenza Negro - Oro



Flor de Lys Negro - Óxido

Ø 19 / 30 mm

Conjuntos completos sin terminales FORJA /
Complete sets excluding finials WROUGHT IRON /
Kits complete sans embouts FER FORGÉ



Ø 19 mm



Negro
Black
Noir

U	Ø 19 REF K.1801	Ø 30	Ø 19/19 REF K.1802	Ø 30/19	cm
1	31,67 €		54,10 €		10
1	40,00 €		70,75 €		16
1	46,55 €		83,86 €		20
1	63,30 €		112,72 €		26
1	69,87 €		125,88 €		30
1	78,20 €		142,53 €		36
1	84,78 €		155,69 €		40



Negro Oro
Black-Gold
Noir-Or

Negro Óxido
Black-Rust
Noir-Rouillé

Marfil Oro
Ivory Gold
Ivoire Or

U	Ø 19 REF K.1801	Ø 30	Ø 19/19 REF K.1802	Ø 30/19	cm
1	37,88 €		64,68 €		10
1	47,79 €		84,50 €		16
1	55,61 €		100,14 €		20
1	75,60 €		134,57 €		26
1	83,44 €		150,26 €		30
1	93,33 €		170,04 €		36
1	101,18 €		185,73 €		40

Ø 30 mm

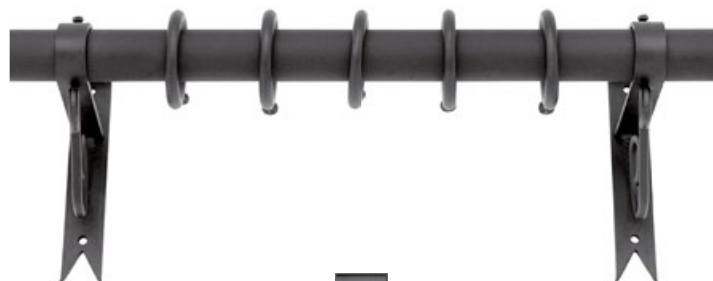

Negro
Black
Noir

U	Ø 19	Ø 30 REF K.1805	Ø 19/19	Ø 30/19 REF K.1806	cm
1		43,29 €		62,40 €	10
1		55,34 €		82,78 €	16
1		64,95 €		98,95 €	20
1		87,81 €		132,27 €	26
1		97,43 €		148,47 €	30
1		109,48 €		168,84 €	36
1		119,09 €		185,04 €	40
1		162,43 €		-	60







Negro Oro
Black-Gold
Noir-Or



Negro Óxido
Black-Rust
Noir-Rouillé

Marfil Oro
Ivory Gold
Ivoire Or

U	Ø 19	Ø 30 REF K.1805	Ø 19/19	Ø 30/19 REF K.1806	cm
1		51,45 €		74,29 €	10
1		65,71 €		98,46 €	16
1		77,03 €		117,60 €	20
1		104,24 €		157,27 €	26
1		115,55 €		176,43 €	30
1		129,81 €		200,58 €	36
1		141,13 €		219,74 €	40
1		190,12 €		-	60

 Los conjuntos de medida superior a 2 m se sirven con 3 soportes.
 Los conjuntos de más de 3 metros se sirven empalmados.
 Conjuntos Sencillos: 2 terminales, 2 soportes, barra y anillas de acero.
 Conjuntos Dobles*: 4 term., 2 sop.dobles, 2 barras y anillas.
 Conjunto Dobles: Se sirven con el mismo terminal para ambas barras.

 All sets with a length longer than 2 meters are supplied with 3 brackets.
 Sets of more than 3 mts. are supplied in 2 halves and splice.
 Single Sets: 2 finials, 2 brackets, pole & steel rings.
 Double Sets*: 4 finials, 2 double brackets, 2 poles & steel rings.
 Double Sets: The Double Sets are supplied with the same finials in both poles.

 Tous les kits de mesures supérieures à 2 mètres contiennent 3 supports.
 Les sets de plus de 3 mts. sont fournis en 2 morceaux avec raccord.
 Kits Simples: 2 embouts, 2 supports, tube et anneaux acier.
 Kits Doubles*: 4 embouts, 2 supports doubles, 2 tubes et anneaux acier.
 Kits Doubles: Sont fournis avec les mêmes embouts pour les deux tringles.

Terminales / Finials / Embouts



Bola

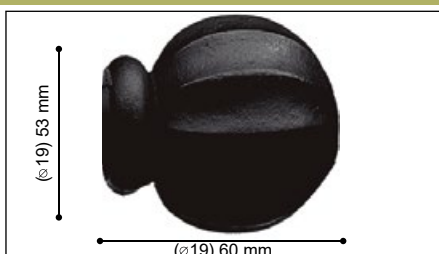

REF	∅				
P.1819N	19	10	5,94 €	6,83 €	
P.1819NO	19	10	7,10 €	8,17 €	
P.1819OX	19	10	7,10 €	8,17 €	
P.1819MO	19	10	7,10 €	8,17 €	

Coliseum



REF	∅				
P.219N	19	10	7,14 €	8,21 €	
P.219NO	19	10	8,56 €	9,84 €	
P.219OX	19	10	8,56 €	9,84 €	
P.219MO	19	10	8,56 €	9,84 €	
P.230N	30	10	11,90 €	13,69 €	
P.230NO	30	10	14,30 €	16,45 €	
P.230OX	30	10	14,30 €	16,45 €	
P.230MO	30	10	14,30 €	16,45 €	

Gajos

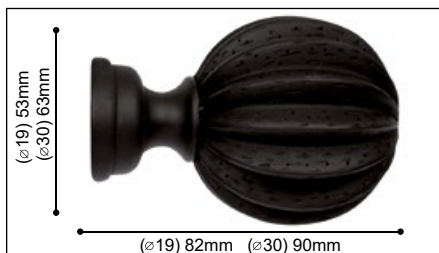

REF	∅				
P.319N	19	10	7,82 €	8,99 €	
P.319NO	19	10	9,38 €	10,79 €	
P.319OX	19	10	9,38 €	10,79 €	
P.319MO	19	10	9,38 €	10,79 €	
P.330N	30	10	13,20 €	15,18 €	
P.330NO	30	10	15,84 €	18,22 €	
P.330OX	30	10	15,84 €	18,22 €	
P.330MO	30	10	15,84 €	18,22 €	

Estrella Plana

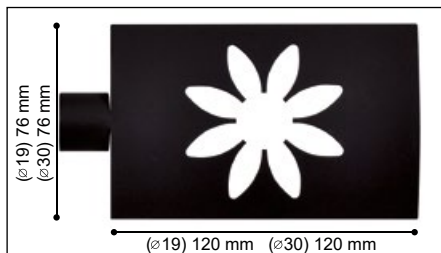

REF	∅				
P.619N	19	10	5,78 €	6,65 €	
P.619NO	19	10	6,94 €	7,98 €	
P.619OX	19	10	6,94 €	7,98 €	
P.619MO	19	10	6,94 €	7,98 €	
K.630N*	30	1	-	10,05 €	
K.630NO*	30	1	-	12,05 €	
K.630OX*	30	1	-	12,05 €	
K.630MO*	30	1	-	12,05 €	

*El terminal de Ø19 emplea un adaptador para convertirse en Ø30. Adaptador incluido en el precio. /
The 30mm finials comprise the finial used for 19mm and one adapter to that purpose included in the price. /
Les embouts de 30mm comprennent l'embout utilisé pour 19mm et un adaptateur à cette fin inclus dans le prix.

Onda Plana

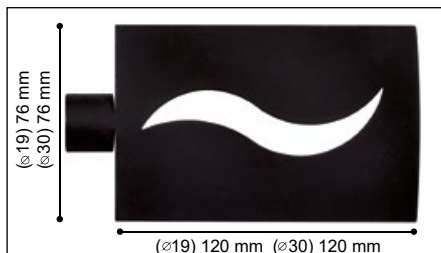

REF	∅				
P.719N	19	10	5,78 €	6,65 €	
P.719NO	19	10	6,94 €	7,98 €	
P.719OX	19	10	6,94 €	7,98 €	
P.719MO	19	10	6,94 €	7,98 €	
K.730N*	30	1	-	10,05 €	
K.730NO*	30	1	-	12,05 €	
K.730OX*	30	1	-	12,05 €	
K.730MO*	30	1	-	12,05 €	

*El terminal de Ø19 emplea un adaptador para convertirse en Ø30. Adaptador incluido en el precio. /
The 30mm finials comprise the finial used for 19mm and one adapter to that purpose included in the price. /
Les embouts de 30mm comprennent l'embout utilisé pour 19mm et un adaptateur à cette fin inclus dans le prix.

Tope



REF	∅				
P.1219N	19	10	5,34 €	6,14 €	
P.1219NO	19	10	6,42 €	7,38 €	
P.1219OX	19	10	6,42 €	7,38 €	
P.1219MO	19	10	6,42 €	7,38 €	
P.830N	30	10	4,58 €	5,27 €	
P.830NO	30	10	5,54 €	6,37 €	
P.830OX	30	10	5,54 €	6,37 €	
P.830MO	30	10	5,54 €	6,37 €	

Terra

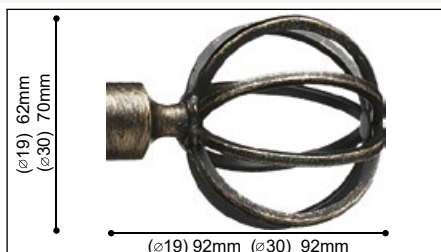

REF	∅				
P.1619N	19	10	7,72 €	8,88 €	
P.1619NO	19	10	9,28 €	10,67 €	
P.1619OX	19	10	9,28 €	10,67 €	
P.1619MO	19	10	9,28 €	10,67 €	
K.1630N*	30	1	-	12,28 €	
K.1630NO*	30	1	-	14,74 €	
K.1630OX*	30	1	-	14,74 €	
K.1630MO*	30	1	-	14,74 €	

*El terminal de Ø19 emplea un adaptador para convertirse en Ø30. Adaptador incluido en el precio. /
The 30mm finials comprise the finial used for 19mm and one adapter to that purpose included in the price. /
Les embouts de 30mm comprennent l'embout utilisé pour 19mm et un adaptateur à cette fin inclus dans le prix.

Feria

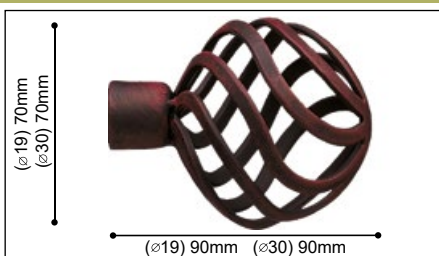

REF	∅	U	€	1	cm
P.5319N	19	10	9,76 €	11,22 €	
P.5319NO	19	10	11,72 €	13,48 €	
P.5319OX	19	10	11,72 €	13,48 €	
P.5319MO	19	10	11,72 €	13,48 €	
K.5330N*	30	1	-	14,63 €	
K.5330NO*	30	1	-	17,55 €	
K.5330OX*	30	1	-	17,55 €	
K.5330MO*	30	1	-	17,55 €	

*El terminal de Ø19 emplea un adaptador para convertirse en Ø30. Adaptador incluido en el precio. / The 30mm finials comprise the finial used for 19mm and one adapter to that purpose included in the price. / Les embouts de 30mm comprennent l'embout utilisé pour 19mm et un adaptateur à cette fin inclus dans le prix.

Báculo



REF	∅	U	€	1	cm
P.019N	19	10	7,26 €	8,35 €	
P.019NO	19	10	8,70 €	10,01 €	
P.019OX	19	10	8,70 €	10,01 €	
P.019MO	19	10	8,70 €	10,01 €	
K.030N*	30	1	-	11,75 €	
K.030NO*	30	1	-	14,08 €	
K.030OX*	30	1	-	14,08 €	
K.030MO*	30	1	-	14,08 €	

*El terminal de Ø19 emplea un adaptador para convertirse en Ø30. Adaptador incluido en el precio. / The 30mm finials comprise the finial used for 19mm and one adapter to that purpose included in the price. / Les embouts de 30mm comprennent l'embout utilisé pour 19mm et un adaptateur à cette fin inclus dans le prix.

Palmera

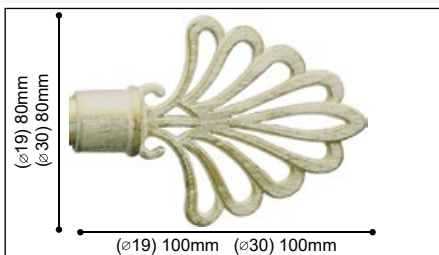

REF	∅	U	€	1	cm
P.419N	19	10	5,40 €	6,21 €	
P.419NO	19	10	6,48 €	7,45 €	
P.419OX	19	10	6,48 €	7,45 €	
P.419MO	19	10	6,48 €	7,45 €	
K.430N*	30	1	-	9,61 €	
K.430NO*	30	1	-	11,52 €	
K.430OX*	30	1	-	11,52 €	
K.430MO*	30	1	-	11,52 €	

*El terminal de Ø19 emplea un adaptador para convertirse en Ø30. Adaptador incluido en el precio. / The 30mm finials comprise the finial used for 19mm and one adapter to that purpose included in the price. / Les embouts de 30mm comprennent l'embout utilisé pour 19mm et un adaptateur à cette fin inclus dans le prix.

Trenza



REF	∅	U	€	1	cm
P.519N	19	10	11,78 €	13,55 €	
P.519NO	19	10	14,14 €	16,26 €	
P.519OX	19	10	14,14 €	16,26 €	
P.519MO	19	10	14,14 €	16,26 €	
K.530N*	30	1	-	16,95 €	
K.530NO*	30	1	-	20,33 €	
K.530OX*	30	1	-	20,33 €	
K.530MO*	30	1	-	20,33 €	

*El terminal de Ø19 emplea un adaptador para convertirse en Ø30. Adaptador incluido en el precio. / The 30mm finials comprise the finial used for 19mm and one adapter to that purpose included in the price. / Les embouts de 30mm comprennent l'embout utilisé pour 19mm et un adaptateur à cette fin inclus dans le prix.

Flor de Lys

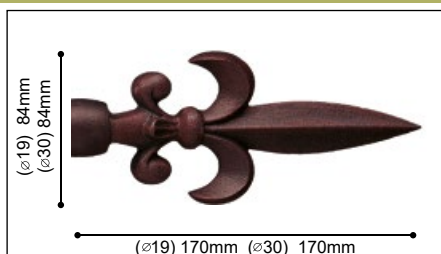

REF	∅				
P.1119N	19	10	9,72 €	11,18 €	
P.1119NO	19	10	11,66 €	13,41 €	
P.1119OX	19	10	11,66 €	13,41 €	
P.1119MO	19	10	11,66 €	13,41 €	
P.1130N	30	10	11,14 €	12,81 €	
P.1130NO	30	10	13,36 €	15,36 €	
P.1130OX	30	10	13,36 €	15,36 €	
P.1130MO	30	10	13,36 €	15,36 €	

Bola

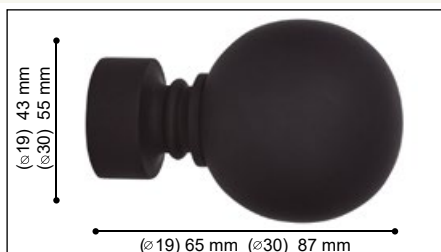

REF	∅				
A.2021N	19	10	6,66 €	7,66 €	
A.2021NO	19	10	7,60 €	8,74 €	
A.2021OX	19	10	7,60 €	8,74 €	
A.2021MO	19	10	7,60 €	8,74 €	
A.2023N	30	10	7,98 €	9,18 €	
A.2023NO	30	10	9,30 €	10,70 €	
A.2023OX	30	10	9,30 €	10,70 €	
A.2023MO	30	10	9,30 €	10,70 €	

NEW

Tapón



REF	∅				
A.6119N	19	10	1,72 €	1,98 €	
A.6119NO	19	10	2,06 €	2,37 €	
A.6119OX	19	10	2,06 €	2,37 €	
A.6119MO	19	10	2,06 €	2,37 €	
A.6130N	30	10	4,50 €	5,18 €	
A.6130NO	30	10	5,40 €	6,21 €	
A.6130OX	30	10	5,40 €	6,21 €	
A.6130MO	30	10	5,40 €	6,21 €	

NEW

Soporte Pared Sencillo
Single Wall Bracket / Support Mur Simple

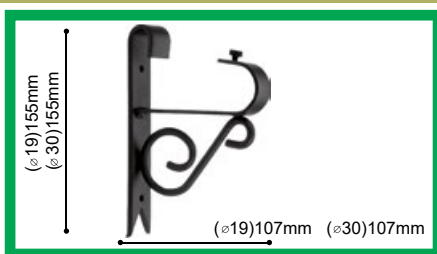

REF	∅	U	€	1	cm
N.1019N	19	10	7,30 €	8,40 €	
N.1019NO	19	10	8,76 €	10,07 €	
N.1019OX	19	10	8,76 €	10,07 €	
N.1019MO	19	10	8,76 €	10,07 €	
N.1030N	30	10	9,40 €	10,81 €	
N.1030NO	30	10	11,26 €	12,95 €	
N.1030OX	30	10	11,26 €	12,95 €	
N.1030MO	30	10	11,26 €	12,95 €	

* Soporte incluido en el Kit Sencillo / Bracket supplied in the Single Kit / Support fourni dans le Simple Kit.

Soporte Pared Doble
Double Wall Bracket / Support Mur Double

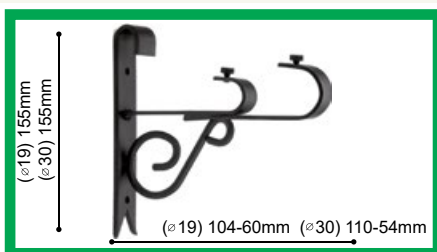

REF	∅	U	€	1	cm
O.101919N	19 / 19	10	10,58 €	12,17 €	
O.101919NO	19 / 19	10	12,70 €	14,61 €	
O.101919OX	19 / 19	10	12,70 €	14,61 €	
O.101919MO	19 / 19	10	12,70 €	14,61 €	
O.103019N	30 / 19	10	11,24 €	12,93 €	
O.103019NO	30 / 19	10	13,48 €	15,50 €	
O.103019OX	30 / 19	10	13,48 €	15,50 €	
O.103019MO	30 / 19	10	13,48 €	15,50 €	

* Soporte incluido en el Kit Doble / Bracket supplied in the Double Kit / Support fourni dans le Double Kit.

Soporte Techo Corto (o pared)
Short Ceiling Bracket (or wall) / Support Plafond Curt (ou mur)







REF	∅	U	€	1	cm
N.10319N	19	10	6,72 €	7,73 €	
N.10319NO	19	10	8,06 €	9,27 €	
N.10319OX	19	10	8,06 €	9,27 €	
N.10319MO	19	10	8,06 €	9,27 €	
N.10330N	30	10	6,72 €	7,73 €	
N.10330NO	30	10	8,06 €	9,27 €	
N.10330OX	30	10	8,06 €	9,27 €	
N.10330MO	30	10	8,06 €	9,27 €	

Soporte Techo Sencillo (o pared)
Simple Ceiling Bracket (or wall) / Support Plafond Simple (ou mur)

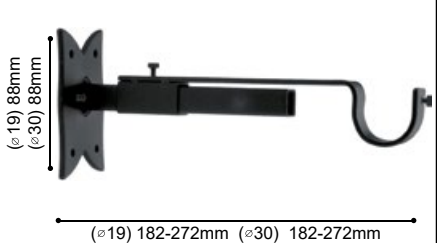
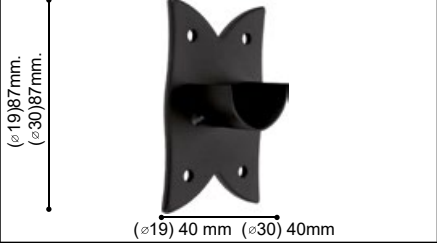

REF	∅	U	€	1	cm
N.10119N	19	10	6,70 €	7,71 €	
N.10119NO	19	10	8,06 €	9,27 €	
N.10119OX	19	10	8,06 €	9,27 €	
N.10119MO	19	10	8,06 €	9,27 €	
N.10130N	30	10	6,70 €	7,71 €	
N.10130NO	30	10	8,06 €	9,27 €	
N.10130OX	30	10	8,06 €	9,27 €	
N.10130MO	30	10	8,06 €	9,27 €	

<p>Soporte Extensible Pared</p> <p>Extensible Wall Bracket / Support Mur Extensible</p>  <p>(\varnothing19) 78mm (\varnothing19) 103-150 mm</p>	REF	\varnothing				
	N.1029N	19	10	6,68 €	7,68 €	
	N.1029NO	19	10	8,00 €	9,20 €	
	N.1029OX	19	10	8,00 €	9,20 €	
	N.1029MO	19	10	8,00 €	9,20 €	
<p>Soporte Extensible Doble de Pared</p> <p>Double Extensible Wall Bracket / Support Mur Double Extensible</p>  <p>(\varnothing19) 80mm (\varnothing19) 105-160mm 60mm</p>	REF	\varnothing				
	O.102929N	19/19	10	7,64 €	8,79 €	
	O.102929NO	19/19	10	9,18 €	10,56 €	
	O.102929OX	19/19	10	9,18 €	10,56 €	
	O.102929MO	19/19	10	9,18 €	10,56 €	
<p>Soporte Extensible Largo de Pared</p> <p>Long Extensible Wall Bracket / Support Mur Long Extensible</p>  <p>(\varnothing19) 88mm (\varnothing30) 88mm (\varnothing19) 182-272mm (\varnothing30) 182-272mm</p>	REF	\varnothing				
	N.10219N	19	10	11,74 €	13,50 €	
	N.10219NO	19	10	14,08 €	16,19 €	
	N.10219OX	19	10	14,08 €	16,19 €	
	N.10219MO	19	10	14,08 €	16,19 €	
	N.10230N	30	10	11,74 €	13,50 €	
	N.10230NO	30	10	14,08 €	16,19 €	
	N.10230OX	30	10	14,08 €	16,19 €	
	N.10230MO	30	10	14,08 €	16,19 €	
	<p>Soporte Dintel</p> <p>Recess Bracket / Support naissance</p>  <p>(\varnothing19) 87mm. (\varnothing30) 87mm. (\varnothing19) 40 mm (\varnothing30) 40mm</p>	REF	\varnothing			
N.10419N		19	10	4,22 €	4,85 €	
N.10419NO		19	10	5,06 €	5,82 €	
N.10419OX		19	10	5,06 €	5,82 €	
N.10419MO		19	10	5,06 €	5,82 €	
N.10430N		30	10	4,22 €	4,85 €	
N.10430NO		30	10	5,06 €	5,82 €	
N.10430OX		30	10	5,06 €	5,82 €	
N.10430MO		30	10	5,06 €	5,82 €	
<p>Adaptador para: Barra de 30mm y Terminal 19 mm</p> <p>19mm Finial Adaptor for pole 30 mm / Adaptateur d'Embout 19mm pour Barre 30 mm</p> 	REF	\varnothing				
	P.6N		10	2,96 €	3,40 €	
	P.6NO		10	3,54 €	4,07 €	
	P.6OX		10	3,54 €	4,07 €	
	P.6MO		10	3,54 €	4,07 €	
<p>Soporte Pared Sencillo</p> <p>Single Wall Bracket / Support Mur Simple</p>  <p>(\varnothing19) 60mm (\varnothing19) 98mm</p>	REF	\varnothing				
	N.3019N	19	25	2,56 €	2,94 €	
	N.3019NO	19	25	3,08 €	3,54 €	
	N.3019OX	19	25	3,08 €	3,54 €	
	N.3019MO	19	25	3,08 €	3,54 €	

SopORTE Pared Doble

Double Wall Bracket / Support Mur Double



REF	∅	U	€	1	cm
O.301919N	19 / 19	25	4,32 €	4,97 €	
O.301919NO	19 / 19	25	5,20 €	5,98 €	
O.301919OX	19 / 19	25	5,20 €	5,98 €	
O.301919MO	19 / 19	25	5,20 €	5,98 €	

SopORTE Techo Doble

Double Ceiling Bracket / Support Plafond Double

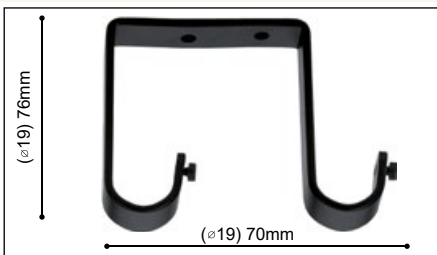

REF	∅	U	€	1	cm
O.321919N	19 / 19	25	5,42 €	6,23 €	
O.321919NO	19 / 19	25	6,50 €	7,48 €	
O.321919OX	19 / 19	25	6,50 €	7,48 €	
O.321919MO	19 / 19	25	6,50 €	7,48 €	

SopORTE Pared Redondo Extensible

Extensible Wall Bracket / Support Mur Extensible



REF	∅	U	€	1	cm
N.20019N	19	10	8,88 €	10,21 €	
N.20019NO	19	10	10,66 €	12,26 €	
N.20019OX	19	10	10,66 €	12,26 €	
N.20019MO	19	10	10,66 €	12,26 €	
N.20030N	30	10	9,24 €	10,63 €	
N.20030NO	30	10	11,08 €	12,74 €	
N.20030OX	30	10	11,08 €	12,74 €	
N.20030MO	30	10	11,08 €	12,74 €	

SopORTE Pared Doble Redondo Extensible

Extensible Double Wall Bracket / Support Double Mur Extensible

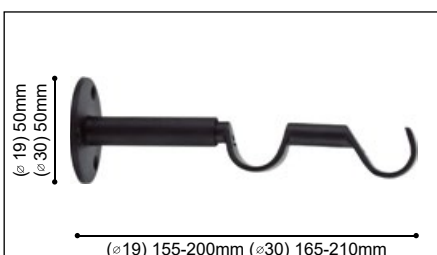

REF	∅	U	€	1	cm
O.21119N	19/19	10	9,48 €	10,90 €	
O.21119NO	19/19	10	11,38 €	13,09 €	
O.21119OX	19/19	10	11,38 €	13,09 €	
O.21119MO	19/19	10	11,38 €	13,09 €	
O.21319N	30/19	10	11,16 €	12,83 €	
O.21319NO	30/19	10	13,40 €	15,41 €	
O.21319OX	30/19	10	13,40 €	15,41 €	
O.21319MO	30/19	10	13,40 €	15,41 €	

SopORTE Dintel

Recess Bracket / Support naissance



REF	∅	U	€	1	cm
A.20419N	19	10	4,90 €	5,64 €	
A.20419NO	19	10	5,52 €	6,35 €	
A.20419OX	19	10	5,52 €	6,35 €	
A.20419MO	19	10	5,52 €	6,35 €	
A.20430N	30	10	5,98 €	6,88 €	
A.20430NO	30	10	6,76 €	7,77 €	
A.20430OX	30	10	6,76 €	7,77 €	
A.20430MO	30	10	6,76 €	7,77 €	

NEW

Accesorios / Accessories / Accessoires

N NO OX MO

Codo Articulado para Tubo de Hierro

Iron Articuled Elbow / Coude en Fer Articulé



REF	∅				
H.150N	19	10	9,74 €	11,20 €	
H.150NO	19	10	11,68 €	13,43 €	
H.150OX	19	10	11,68 €	13,43 €	
H.150MO	19	10	11,68 €	13,43 €	
H.151N	30	10	14,16 €	16,28 €	
H.151NO	30	10	16,98 €	19,53 €	
H.151OX	30	10	16,98 €	19,53 €	
H.151MO	30	10	16,98 €	19,53 €	

Gancho

Hook / Gond



REF	∅				
R.1001N		50	1,52 €	1,75 €	
R.1001NO		50	1,80 €	2,07 €	
R.1001OX		50	1,80 €	2,07 €	
R.1001MO		50	1,80 €	2,07 €	
R.1002N		50	1,66 €	1,91 €	
R.1002NO		50	1,90 €	2,19 €	
R.1002OX		50	1,90 €	2,19 €	
R.1002MO		50	1,90 €	2,19 €	

Empalme para Barra de Forja

Pole Splice / Raccord pour des Tringles en fer Forgé

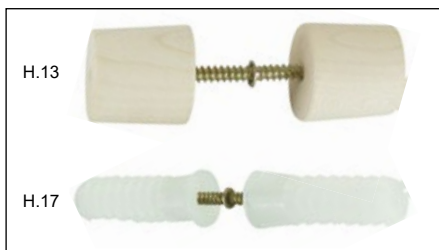

REF	∅				
H.17	19	10	1,44 €	1,66 €	
H.13	30	10	4,78 €	5,50 €	

Anillas Hierro

Iron Ring / Anneaux Fer



REF	∅				
H.20619N	19	100	0,42 €	0,50 €	
H.20619NO	19	100	0,44 €	0,53 €	
H.20619OX	19	100	0,44 €	0,53 €	
H.20619MO	19	100	0,44 €	0,53 €	

Anillas con Teflón

Ring with teflon / Anneaux avec teflon

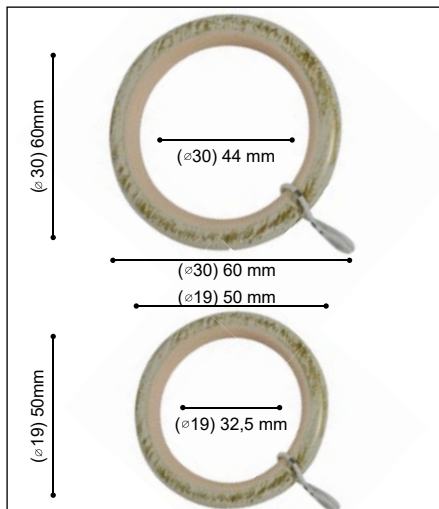

REF	∅				
H.20730N	19	100	0,76 €	0,87 €	
H.20730NO	19	100	0,90 €	1,04 €	
H.20730OX	19	100	0,90 €	1,04 €	
H.20730MO	19	100	0,90 €	1,04 €	
H.20830N	30	50	1,06 €	1,22 €	
H.20830NO	30	50	1,28 €	1,47 €	
H.20830OX	30	50	1,28 €	1,47 €	
H.20830MO	30	50	1,28 €	1,47 €	

Barra Negro - Oro

Black - Gold Pole /
Tube Noir - Or



REF	∅	U	€	1	cm
C.12219NO100	19	10	6,42 €	7,38 €	100
C.12219NO150	19	10	9,64 €	11,09 €	150
C.12219NO200	19	10	12,84 €	14,77 €	200
C.12219NO250	19	10	16,06 €	18,47 €	250
C.12219NO300	19	10	19,28 €	22,17 €	300
C.12219NO600	19	5	38,56 €	44,34 €	600
C.12230NO100	30	10	9,42 €	10,83 €	100
C.12230NO150	30	10	14,14 €	16,26 €	150
C.12230NO200	30	10	18,86 €	21,69 €	200
C.12230NO250	30	10	23,58 €	27,12 €	250
C.12230NO300	30	10	28,30 €	32,55 €	300
C.12230NO600	30	5	54,74 €	62,95 €	600

Barra
Marfil - Oro

Ivory - Gold Pole /
Tube Ivoire - Or



REF	∅	U	€	1	cm
C.12219MO100	19	10	6,42 €	7,38 €	100
C.12219MO150	19	10	9,64 €	11,09 €	150
C.12219MO200	19	10	12,84 €	14,77 €	200
C.12219MO250	19	10	16,06 €	18,47 €	250
C.12219MO300	19	10	19,28 €	22,17 €	300
C.12219MO600	19	5	38,56 €	44,34 €	600
C.12230MO100	30	10	9,42 €	10,83 €	100
C.12230MO150	30	10	14,14 €	16,26 €	150
C.12230MO200	30	10	18,86 €	21,69 €	200
C.12230MO250	30	10	23,58 €	27,12 €	250
C.12230MO300	30	10	28,30 €	32,55 €	300
C.12230MO600	30	5	54,74 €	62,95 €	600

Barra
Negro - Óxido

Black-Rust Pole /
Tube Noir-Rouillé





REF	∅	U	€	1	cm
C.12219OX100	19	10	6,42 €	7,38 €	100
C.12219OX150	19	10	9,64 €	11,09 €	150
C.12219OX200	19	10	12,84 €	14,77 €	200
C.12219OX250	19	10	16,06 €	18,47 €	250
C.12219OX300	19	10	19,28 €	22,17 €	300
C.12219OX600	19	5	38,56 €	44,34 €	600
C.12230OX100	30	10	9,42 €	10,83 €	100
C.12230OX150	30	10	14,14 €	16,26 €	150
C.12230OX200	30	10	18,86 €	21,69 €	200
C.12230OX250	30	10	23,58 €	27,12 €	250
C.12230OX300	30	10	28,30 €	32,55 €	300
C.12230OX600	30	5	54,74 €	62,95 €	600

Barra Negra

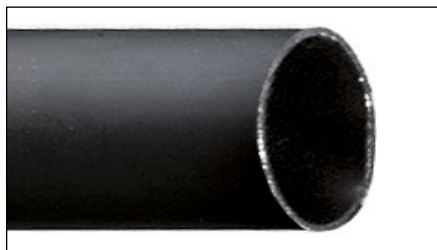
Black Pole /
Tube Noir



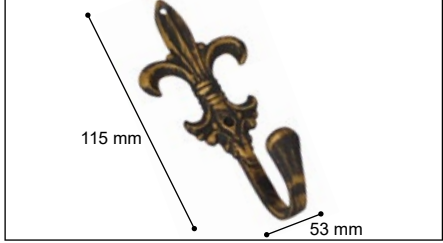

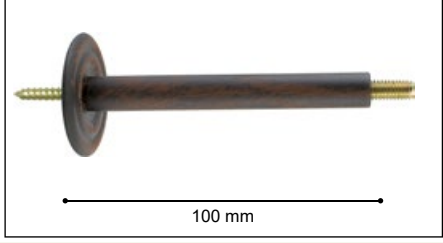

REF	∅	U	€	1	cm
C.12219N100	19	10	5,34 €	6,14 €	100
C.12219N150	19	10	8,02 €	9,22 €	150
C.12219N200	19	10	10,68 €	12,28 €	200
C.12219N250	19	10	13,38 €	15,39 €	250
C.12219N300	19	10	16,06 €	18,47 €	300
C.12219N600	19	5	32,14 €	36,96 €	600
C.12230N100	30	10	8,24 €	9,48 €	100
C.12230N150	30	10	12,36 €	14,21 €	150
C.12230N200	30	10	16,48 €	18,95 €	200
C.12230N250	30	10	20,60 €	23,69 €	250
C.12230N300	30	10	24,72 €	28,43 €	300
C.12230N600	30	5	49,44 €	56,86 €	600

<p>Tirador Iron Wand / Lance Rideau</p>		<table border="1"> <thead> <tr> <th>REF</th> <th>∅</th> <th>U</th> <th>€</th> <th>€</th> <th>cm</th> </tr> </thead> <tbody> <tr> <td>L.11N</td> <td></td> <td>25</td> <td>2,20 €</td> <td>2,53 €</td> <td>100</td> </tr> <tr> <td>L.11NO</td> <td></td> <td>25</td> <td>2,64 €</td> <td>3,04 €</td> <td>100</td> </tr> <tr> <td>L.11OX</td> <td></td> <td>25</td> <td>2,64 €</td> <td>3,04 €</td> <td>100</td> </tr> <tr> <td>L.11MO</td> <td></td> <td>25</td> <td>2,64 €</td> <td>3,04 €</td> <td>100</td> </tr> </tbody> </table>	REF	∅	U	€	€	cm	L.11N		25	2,20 €	2,53 €	100	L.11NO		25	2,64 €	3,04 €	100	L.11OX		25	2,64 €	3,04 €	100	L.11MO		25	2,64 €	3,04 €	100						
REF	∅	U	€	€	cm																																	
L.11N		25	2,20 €	2,53 €	100																																	
L.11NO		25	2,64 €	3,04 €	100																																	
L.11OX		25	2,64 €	3,04 €	100																																	
L.11MO		25	2,64 €	3,04 €	100																																	
<p>Alzapaños Flor de Lys Fleur-de-Lys holdback / Embrasse de rideau Fleur de Lys</p>	 <p>115 mm 53 mm</p>	<table border="1"> <thead> <tr> <th>REF</th> <th>∅</th> <th>U</th> <th>€</th> <th>€</th> <th>cm</th> </tr> </thead> <tbody> <tr> <td>R.1125N</td> <td></td> <td>25</td> <td>3,38 €</td> <td>3,89 €</td> <td></td> </tr> <tr> <td>R.1125NO</td> <td></td> <td>25</td> <td>4,06 €</td> <td>4,67 €</td> <td></td> </tr> <tr> <td>R.1125OX</td> <td></td> <td>25</td> <td>4,06 €</td> <td>4,67 €</td> <td></td> </tr> <tr> <td>R.1125MO</td> <td></td> <td>25</td> <td>4,06 €</td> <td>4,67 €</td> <td></td> </tr> </tbody> </table>	REF	∅	U	€	€	cm	R.1125N		25	3,38 €	3,89 €		R.1125NO		25	4,06 €	4,67 €		R.1125OX		25	4,06 €	4,67 €		R.1125MO		25	4,06 €	4,67 €							
REF	∅	U	€	€	cm																																	
R.1125N		25	3,38 €	3,89 €																																		
R.1125NO		25	4,06 €	4,67 €																																		
R.1125OX		25	4,06 €	4,67 €																																		
R.1125MO		25	4,06 €	4,67 €																																		
<p>*Abrazadera *Holdback / *Embrasse</p>	 <p>260 mm</p> <p>* Para usar con rosetón o terminal * To use with any rosette or finial * Pour utiliser avec paterres ou embout</p>	<table border="1"> <thead> <tr> <th>REF</th> <th>∅</th> <th>U</th> <th>€</th> <th>€</th> <th>cm</th> </tr> </thead> <tbody> <tr> <td>R.1326N</td> <td></td> <td>10</td> <td>6,70 €</td> <td>7,71 €</td> <td></td> </tr> <tr> <td>R.1326NO</td> <td></td> <td>10</td> <td>8,04 €</td> <td>9,25 €</td> <td></td> </tr> <tr> <td>R.1326OX</td> <td></td> <td>10</td> <td>8,04 €</td> <td>9,25 €</td> <td></td> </tr> <tr> <td>R.1326MO</td> <td></td> <td>10</td> <td>8,04 €</td> <td>9,25 €</td> <td></td> </tr> </tbody> </table>	REF	∅	U	€	€	cm	R.1326N		10	6,70 €	7,71 €		R.1326NO		10	8,04 €	9,25 €		R.1326OX		10	8,04 €	9,25 €		R.1326MO		10	8,04 €	9,25 €							
REF	∅	U	€	€	cm																																	
R.1326N		10	6,70 €	7,71 €																																		
R.1326NO		10	8,04 €	9,25 €																																		
R.1326OX		10	8,04 €	9,25 €																																		
R.1326MO		10	8,04 €	9,25 €																																		
<p>Rosetón (resina) Rosette (resin) / Rosace (résine)</p>	 <p>65 mm</p>	<table border="1"> <thead> <tr> <th>REF</th> <th>∅</th> <th>U</th> <th>€</th> <th>€</th> <th>cm</th> </tr> </thead> <tbody> <tr> <td>R.1328N</td> <td></td> <td>10</td> <td>4,28 €</td> <td>4,92 €</td> <td></td> </tr> <tr> <td>R.1328NO</td> <td></td> <td>10</td> <td>5,16 €</td> <td>5,93 €</td> <td></td> </tr> <tr> <td>R.1328OX</td> <td></td> <td>10</td> <td>5,16 €</td> <td>5,93 €</td> <td></td> </tr> <tr> <td>R.1328MO</td> <td></td> <td>10</td> <td>5,16 €</td> <td>5,93 €</td> <td></td> </tr> </tbody> </table>	REF	∅	U	€	€	cm	R.1328N		10	4,28 €	4,92 €		R.1328NO		10	5,16 €	5,93 €		R.1328OX		10	5,16 €	5,93 €		R.1328MO		10	5,16 €	5,93 €							
REF	∅	U	€	€	cm																																	
R.1328N		10	4,28 €	4,92 €																																		
R.1328NO		10	5,16 €	5,93 €																																		
R.1328OX		10	5,16 €	5,93 €																																		
R.1328MO		10	5,16 €	5,93 €																																		
<p>Prolongador Spindle / Balustre</p>	 <p>100 mm</p>	<table border="1"> <thead> <tr> <th>REF</th> <th>∅</th> <th>U</th> <th>€</th> <th>€</th> <th>cm</th> </tr> </thead> <tbody> <tr> <td>R.1166N</td> <td></td> <td>25</td> <td>4,76 €</td> <td>5,47 €</td> <td></td> </tr> <tr> <td>R.1166NO</td> <td></td> <td>25</td> <td>5,70 €</td> <td>6,56 €</td> <td></td> </tr> <tr> <td>R.1166OX</td> <td></td> <td>25</td> <td>5,70 €</td> <td>6,56 €</td> <td></td> </tr> <tr> <td>R.1166MO</td> <td></td> <td>25</td> <td>5,70 €</td> <td>6,56 €</td> <td></td> </tr> </tbody> </table>	REF	∅	U	€	€	cm	R.1166N		25	4,76 €	5,47 €		R.1166NO		25	5,70 €	6,56 €		R.1166OX		25	5,70 €	6,56 €		R.1166MO		25	5,70 €	6,56 €							
REF	∅	U	€	€	cm																																	
R.1166N		25	4,76 €	5,47 €																																		
R.1166NO		25	5,70 €	6,56 €																																		
R.1166OX		25	5,70 €	6,56 €																																		
R.1166MO		25	5,70 €	6,56 €																																		
<p>Prolongador Spindle / Balustre</p>	 <p>150 mm</p>	<table border="1"> <thead> <tr> <th>REF</th> <th>∅</th> <th>U</th> <th>€</th> <th>€</th> <th>cm</th> </tr> </thead> <tbody> <tr> <td>R.1167N</td> <td></td> <td>25</td> <td>5,70 €</td> <td>6,56 €</td> <td></td> </tr> <tr> <td>R.1167NO</td> <td></td> <td>25</td> <td>6,84 €</td> <td>7,87 €</td> <td></td> </tr> <tr> <td>R.1167OX</td> <td></td> <td>25</td> <td>6,84 €</td> <td>7,87 €</td> <td></td> </tr> <tr> <td>R.1167MO</td> <td></td> <td>25</td> <td>6,84 €</td> <td>7,87 €</td> <td></td> </tr> </tbody> </table>	REF	∅	U	€	€	cm	R.1167N		25	5,70 €	6,56 €		R.1167NO		25	6,84 €	7,87 €		R.1167OX		25	6,84 €	7,87 €		R.1167MO		25	6,84 €	7,87 €							
REF	∅	U	€	€	cm																																	
R.1167N		25	5,70 €	6,56 €																																		
R.1167NO		25	6,84 €	7,87 €																																		
R.1167OX		25	6,84 €	7,87 €																																		
R.1167MO		25	6,84 €	7,87 €																																		
<p>Prolongador Spindle / Balustre</p>	 <p>200 mm</p>	<table border="1"> <thead> <tr> <th>REF</th> <th>∅</th> <th>U</th> <th>€</th> <th>€</th> <th>cm</th> </tr> </thead> <tbody> <tr> <td>R.1168N</td> <td></td> <td>25</td> <td>10,66 €</td> <td>12,26 €</td> <td></td> </tr> <tr> <td>R.1168NO</td> <td></td> <td>25</td> <td>12,64 €</td> <td>14,54 €</td> <td></td> </tr> <tr> <td>R.1168OX</td> <td></td> <td>25</td> <td>12,64 €</td> <td>14,54 €</td> <td></td> </tr> <tr> <td>R.1168MO</td> <td></td> <td>25</td> <td>12,64 €</td> <td>14,54 €</td> <td></td> </tr> </tbody> </table>	REF	∅	U	€	€	cm	R.1168N		25	10,66 €	12,26 €		R.1168NO		25	12,64 €	14,54 €		R.1168OX		25	12,64 €	14,54 €		R.1168MO		25	12,64 €	14,54 €							
REF	∅	U	€	€	cm																																	
R.1168N		25	10,66 €	12,26 €																																		
R.1168NO		25	12,64 €	14,54 €																																		
R.1168OX		25	12,64 €	14,54 €																																		
R.1168MO		25	12,64 €	14,54 €																																		
<p>Expositor FORJA 1 Wrought Iron Display Board 1 / Présentoir FORGE 1</p>		<table border="1"> <thead> <tr> <th>REF</th> <th>∅</th> <th>U</th> <th>€</th> <th>€</th> <th>cm</th> </tr> </thead> <tbody> <tr> <td>M.214</td> <td></td> <td>1</td> <td></td> <td>52,94 €</td> <td></td> </tr> </tbody> </table>	REF	∅	U	€	€	cm	M.214		1		52,94 €																									
REF	∅	U	€	€	cm																																	
M.214		1		52,94 €																																		

Expositor
FORJA 2

Wrought Iron
Display Board 2/
Presentoir FORGE 2



REF	∅				
M.208		1		52,94 €	

FORJA WROUGHT IRON



www.altransolutions.es



ALTRAN[®]
SISTEMAS PARA DECORAR CORTINAS

Colección Belmonte

Una habitación con vistas por la que entra el aire de la toscana.
Una cortina mecida por el viento deja ver el paisaje. Respiro.

BARRAS

LA CORTINA TRADICIONAL HA VUELTO



ALTRAN[®]
SISTEMAS PARA DECORAR CORTINAS



ALTRAN[®]
SISTEMAS PARA DECORAR CORTINAS

Barra de Cortina BELMONTE / BELMONTE Curtain Pole / Tringle BELMONTE



Llama Bronce



Llama Negro-Plata



Llama Marfil



Llama Plata-Oro



Llama Blanco-Plata



Llama Oro-Rojo

La Colección Belmonte está desarrollada en Madera y presenta 6 terminales en 6 colores diferentes. Se trata de una colección de estilo clásico pero donde lo más llamativo es su potente colorido moderno que la convierte en la combinación más actual en la decoración. Los estilos Vintage, DIY, Nórdico... están de enhorabuena con la aparición de esta colección capaz de unificar estilos de gran popularidad actualmente. Se trata de una colección que nos han pedido decoradores e interioristas y por fin, la hemos diseñado.

The Belmonte Collection is made of wood and offered in 6 finials with 6 different colors. It is a classic style collection but due to its appealing colorful look it becomes the latest trendy combination in terms of decoration. Happy time for people fond of the vintage, DIY and Nordic trends, our new collection gets all in one. It has been very demanded by Decorators and Interior Designers, and finally we are launching it.

La colección Belmonte est entièrement réalisée en bois et se présente en 6 embouts avec 6 gammes de couleurs. Il s'agit d'une collection classique et élégante mais prendre l'apparence d'une gamme de top tendance née de son choquante colori visuel. Des beaux jours pour les amants des modes vintage, DIY et Nordique, en apportant une véritable solution tout-en-un. Très demandée par Concepteurs et Décorateurs d'intérieur, finalement nous l'avons mis sur le marché.



∅ 35 mm



Bola Estriada Bronce



Bola Estriada Plata



Bola Estriada Marfil



Bola Estriada Plata-Oro



Bola Estriada Blanco-Plata



Bola Estriada Oro-Rojo



Bellota Bronce



Bellota Negro-Plata



Bellota Marfil



Bellota Plata-Oro



Bellota Blanco-Plata



Bellota Oro-Rojo

∅ 35 mm



Vela Bronce



Vela Negro-Plata



Vela Marfil



Vela Plata-Oro



Vela Blanco-Plata



Vela Oro-Rojo

∅ 35 mm



Tapón Bronce



Tapón Negro-Plata



Tapón Marfil

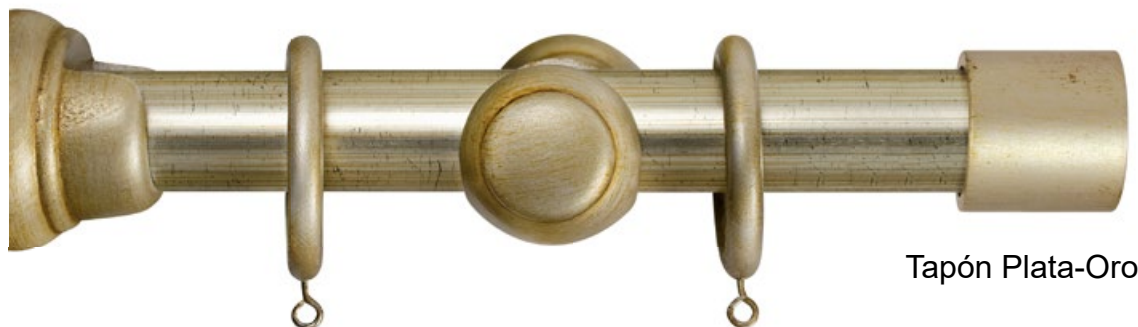

Tapón Plata-Oro



Tapón Blanco-Plata



Tapón Oro-Rojo

∅ 35 mm

Conjuntos completos BELMONTE /
Complete sets BELMONTE /
Kits complete BELMONTE



Llama



U	Ø 35 REF K.18604	Ø 35/35 REF K.18605	cm
1	200,19 €	400,15 €	16
1	220,98 €	441,74 €	20
1	259,42 €	518,49 €	24
1	290,61 €	580,87 €	30

Cáliz



U	Ø 35 REF K.18204	Ø 35/35 REF K.18205	cm
1	155,89 €	311,56 €	16
1	176,69 €	353,14 €	20
1	215,12 €	429,89 €	24
1	246,31 €	492,27 €	30

Bola Estriada



U	Ø 35 REF K.18304	Ø 35/35 REF K.18305	cm
1	150,56 €	300,89 €	16
1	171,35 €	342,47 €	20
1	209,78 €	419,22 €	24
1	240,97 €	481,60 €	30

Bellota



U	Ø 35 REF K.18404	Ø 35/35 REF K.18405	cm
1	200,19 €	400,15 €	16
1	220,98 €	441,74 €	20
1	259,42 €	518,49 €	24
1	290,61 €	580,87 €	30

Vela



U	Ø 35 REF K.18504	Ø 35/35 REF K.18505	cm
1	200,19 €	400,15 €	16
1	220,98 €	441,74 €	20
1	259,42 €	518,49 €	24
1	290,61 €	580,87 €	30

Tapón



U	Ø 35 REF K.18104	Ø 35/35 REF K.18105	cm
1	139,66 €	279,08 €	16
1	160,45 €	320,67 €	20
1	198,88 €	397,42 €	24
1	230,07 €	459,79 €	30

Los conjuntos dobles se sirven con los mismos terminales si no se indica lo contrario.
 Los conjuntos de medida superior a 2 m se sirven con 3 soportes.
 Conjuntos Sencillos: 2 terminales, 2 soportes, barra y anillas.
 Conjuntos Dobles: 4 term., 2 sop.dobles, 2 barras y anillas.
 Indique en su pedido el acabado y la medida de la barra que desea.

Double sets are supplied with the same finials in both poles if not especificed.
 All sets with a length longer than 2 meters are supplied with 3 brackets.
 Single sets: 2 finials, 2 brackets, pole & rings.
 Double sets: 4 finials, 2 double brackets, 2 poles & rings.
 When ordering, please specify finish and size of pole.

Kits doubles sont fournis avec les mêmes embouts en deux barres sinon spécifié.
 Tous les kits de mesures supérieures à 2 mètres contiennent 3 supports.
 Kits simples: 2 embouts, 2 supports, tube et anneaux.
 Kits doubles: 4 embouts, 2 supports doubles, 2 tubes et anneaux.
 Merci de spécifier la finition et la taille de la barre.

Importante / Important / Important

Las barras Belmonte se sirven taladradas por ambos extremos para una fácil instalación del terminal. Si corta la barra en algún extremo, para facilitar la correcta y rápida instalación del terminal, es necesario taladrar el centro de los nuevos extremos cortados, con un taladro de 5 mm de diámetro y con 4 cm de profundidad para poder colocar el terminal. /

The Belmonte poles are supplied drilled on both ends for easy installation of finials. If you need to cut the poles, for an easy and proper finial installation, you should drill the center of the new end/s cut, with a 5mm diameter drill and making a hole of 4cm in order the finial fits in correctly. /

Les tringles en bois Belmonte sont fournies percées dans les extrémités pour assurer une installation correcte des embouts. Si vous avez besoin de couper les tringles, et pour assurer une installation correcte des embouts, vous devez percer le/s extrémité/s coupées avec une perceuse de 5mm et faire un trou de 4cm afin que les embouts s'ajustent parfaitement.

Terminales / Finials / Embouts



Llama



REF	∅	U	€	€	cm
P.30133520	35	6	35,54 €	40,87 €	
P.30133521	35	6	35,54 €	40,87 €	
P.30133522	35	6	35,54 €	40,87 €	
P.30133523	35	6	35,54 €	40,87 €	
P.30133524	35	6	35,54 €	40,87 €	
P.30133525	35	6	35,54 €	40,87 €	

Cáliz

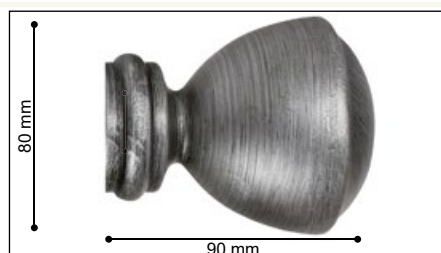

REF	∅	U	€	€	cm
P.30153520	35	6	16,28 €	18,72 €	
P.30153521	35	6	16,28 €	18,72 €	
P.30153522	35	6	16,28 €	18,72 €	
P.30153523	35	6	16,28 €	18,72 €	
P.30153524	35	6	16,28 €	18,72 €	
P.30153525	35	6	16,28 €	18,72 €	

Bola Estriada

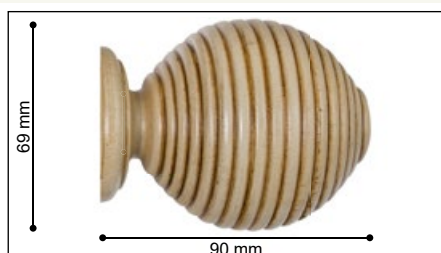

REF	∅	U	€	€	cm
P.30143520	35	6	13,96 €	16,05 €	
P.30143521	35	6	13,96 €	16,05 €	
P.30143522	35	6	13,96 €	16,05 €	
P.30143523	35	6	13,96 €	16,05 €	
P.30143524	35	6	13,96 €	16,05 €	
P.30143525	35	6	13,96 €	16,05 €	

Bellota



REF	∅	U	€	€	cm
P.30113520	35	6	35,54 €	40,87 €	
P.30113521	35	6	35,54 €	40,87 €	
P.30113522	35	6	35,54 €	40,87 €	
P.30113523	35	6	35,54 €	40,87 €	
P.30113524	35	6	35,54 €	40,87 €	
P.30113525	35	6	35,54 €	40,87 €	

Terminales / Finials / Embouts



Vela



REF	∅	U	€	€ ¹	cm
P.30123520	35	6	35,54 €	40,87 €	
P.30123521	35	6	35,54 €	40,87 €	
P.30123522	35	6	35,54 €	40,87 €	
P.30123523	35	6	35,54 €	40,87 €	
P.30123524	35	6	35,54 €	40,87 €	
P.30123525	35	6	35,54 €	40,87 €	

Tapón

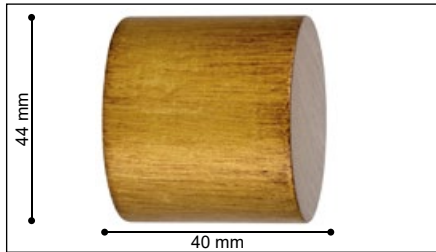

REF	∅	U	€	€ ¹	cm
P.30103520	35	6	9,22 €	10,60 €	
P.30103521	35	6	9,22 €	10,60 €	
P.30103522	35	6	9,22 €	10,60 €	
P.30103523	35	6	9,22 €	10,60 €	
P.30103524	35	6	9,22 €	10,60 €	
P.30103525	35	6	9,22 €	10,60 €	

Accesorios / Accessories / Accessoires



Soporte Madera Clásico 35 mm

Classic Wooden Bracket 35 mm / Support Bois Classique 35 mm

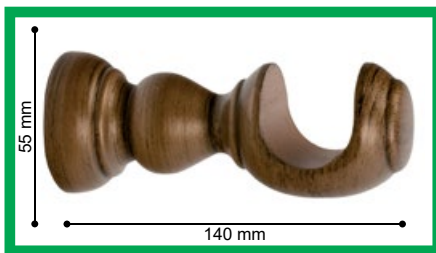

REF	∅	U	€	€ ¹	cm
N.9003520	35	6	15,34 €	17,64 €	
N.9003521	35	6	15,34 €	17,64 €	
N.9003522	35	6	15,34 €	17,64 €	
N.9003523	35	6	15,34 €	17,64 €	
N.9003524	35	6	15,34 €	17,64 €	
N.9003525	35	6	15,34 €	17,64 €	

* Soporte incluido en el Kit Sencillo / Bracket supplied in the Single Kit / Support fourni dans le Simple Kit.

Soporte Madera Clásico Doble 35 / 35 mm

Classic Wooden Double Bracket 35 / 35 mm / Double Support Bois Classique 35 / 35 mm

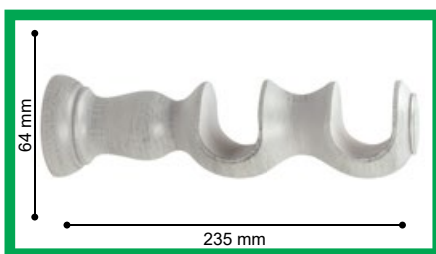

REF	∅	U	€	€ ¹	cm
O.9133520	35	6	30,58 €	35,17 €	
O.9133521	35	6	30,58 €	35,17 €	
O.9133522	35	6	30,58 €	35,17 €	
O.9133523	35	6	30,58 €	35,17 €	
O.9133524	35	6	30,58 €	35,17 €	
O.9133525	35	6	30,58 €	35,17 €	

* Soporte incluido en el Kit Doble / Bracket supplied in the Double Kit / Support fourni dans le Double Kit.

Soporte Madera Clásico Techo 35 mm

Classic Wooden Ceiling Bracket 35 mm / Plafond Support Bois Classique 35 mm



REF	∅	U	€	€ ¹	cm
N.9013520	35	6	15,34 €	17,64 €	
N.9013521	35	6	15,34 €	17,64 €	
N.9013522	35	6	15,34 €	17,64 €	
N.9013523	35	6	15,34 €	17,64 €	
N.9013524	35	6	15,34 €	17,64 €	
N.9013525	35	6	15,34 €	17,64 €	

Accesorios / Accessories / Accessoires



Soporte Madera Clásico Largo 35 mm Classic Wooden Long Bracket 35 mm / Long Support Bois Classique 35 mm		REF	∅					
		N.9023520	35	6	23,30 €	26,80 €		
		N.9023521	35	6	23,30 €	26,80 €		
		N.9023522	35	6	23,30 €	26,80 €		
		N.9023523	35	6	23,30 €	26,80 €		
		N.9023524	35	6	23,30 €	26,80 €		
N.9023525	35	6	23,30 €	26,80 €				
Soporte Madera Clásico Dintel 35 mm Classic Wooden Recess Bracket 35 mm / Support Naissance Bois Classique 35 mm		REF	∅					
		N.9043520	35	6	11,94 €	13,73 €		
		N.9043521	35	6	11,94 €	13,73 €		
		N.9043522	35	6	11,94 €	13,73 €		
		N.9043523	35	6	11,94 €	13,73 €		
		N.9043524	35	6	11,94 €	13,73 €		
N.9043525	35	6	11,94 €	13,73 €				
Anilla Madera 35 mm Wooden Ring / Anneau Bois		REF	∅					
		H.2003520	35	100	1,60 €	1,84 €		
		H.2003521	35	100	1,60 €	1,84 €		
		H.2003522	35	100	1,60 €	1,84 €		
		H.2003523	35	100	1,60 €	1,84 €		
		H.2003524	35	100	1,60 €	1,84 €		
H.2003525	35	100	1,60 €	1,84 €				
Tirador Madera 1 m Wooden Wand 1 m / Baton Bois 1 m		REF	∅					
		L.420			6	25,44 €	29,26 €	100
		L.421			6	25,44 €	29,26 €	100
		L.422			6	25,44 €	29,26 €	100
		L.423			6	25,44 €	29,26 €	100
		L.424			6	25,44 €	29,26 €	100
L.425			6	25,44 €	29,26 €	100		
Alzapaño Madera Acortable Tailored Wooden Holdback / Embrasse Bois Raccourcissable		REF	∅					
		R.10020	35	6	17,58 €	20,22 €		
		R.10021	35	6	17,58 €	20,22 €		
		R.10022	35	6	17,58 €	20,22 €		
		R.10023	35	6	17,58 €	20,22 €		
		R.10024	35	6	17,58 €	20,22 €		
R.10025	35	6	17,58 €	20,22 €				
Barra de Madera 35 mm Bronce Wooden Poles 35 mm Bronze / Barre Bois 35 mm Bronze		REF	∅					
		G.2035160	35	6	46,72 €	53,73 €	160	
		G.2035200	35	6	58,40 €	67,16 €	200	
		G.2035240	35	6	70,08 €	80,59 €	240	
		G.2035300	35	6	87,60 €	100,74 €	300	
Barra de Madera 35 mm Negro-Plata Wooden Poles 35 mm Black-Silver / Barre Bois 35 mm Noir-Argent		REF	∅					
		G.2135160	35	6	46,72 €	53,73 €	160	
		G.2135200	35	6	58,40 €	67,16 €	200	
		G.2135240	35	6	70,08 €	80,59 €	240	
		G.2135300	35	6	87,60 €	100,74 €	300	
Barra de Madera 35 mm Marfil Wooden Poles 35 mm Ivory / Barre Bois 35 mm Ivoire		REF	∅					
		G.2235160	35	6	46,72 €	53,73 €	160	
		G.2235200	35	6	58,40 €	67,16 €	200	
		G.2235240	35	6	70,08 €	80,59 €	240	
		G.2235300	35	6	87,60 €	100,74 €	300	

Accesorios / Accessories / Accessoires



Barra de Madera 35 mm Plata-Oro
Wooden Poles 35 mm Silver-Gold / Barre Bois 35 mm Argent-Or

REF	∅	U	€	€ ¹	cm
G.2335160	35	6	46,72 €	53,73 €	160
G.2335200	35	6	58,40 €	67,16 €	200
G.2335240	35	6	70,08 €	80,59 €	240
G.2335300	35	6	87,60 €	100,74 €	300

Barra de Madera 35 mm Blanco-Plata
Wooden Poles 35 mm White-Silver / Barre Bois 35 mm Blanc-Argent

REF	∅	U	€	€ ¹	cm
G.2435160	35	6	46,72 €	53,73 €	160
G.2435200	35	6	58,40 €	67,16 €	200
G.2435240	35	6	70,08 €	80,59 €	240
G.2435300	35	6	87,60 €	100,74 €	300

Barra de Madera 35 mm Oro-Rojo
Wooden Poles 35 mm Red-Gold / Barre Bois 35 mm Or-Rouge

REF	∅	U	€	€ ¹	cm
G.2535160	35	6	46,72 €	53,73 €	160
G.2535200	35	6	58,40 €	67,16 €	200
G.2535240	35	6	70,08 €	80,59 €	240
G.2535300	35	6	87,60 €	100,74 €	300

Dowell de Empalme 60 mm x 5 mm
Joining Dowell / Dowell raccordeur

REF	∅	U	€	€ ¹	cm
V.58		100	0,64 €	0,73 €	

Expositor BELMONTE
Exhibitor Belmonte / Presentoir Belmonte

REF	∅	U	€	€ ¹	cm
M.217	35	1		127,46 €	



ALTRAN[®]

CURTAIN DECORATION SYSTEMS

Barra de Cortina ECLIPSE / ECLIPSE Curtain Pole / Tringle a Rideux ECLIPSE



Cilindro Roble



Cono Invertido Teka



Bola Pino



Olimpo Blanco



Cilindro Wengué

 La madera más noble es el material con el que se diseña esta colección. El estilo joven que transmite y el material empleado, dan solución a numerosas decoraciones donde se quiera conseguir el grado más alto de integración posible con la estancia. Gracias a sus diferentes soportes, podremos instalar esta colección en cualquier lugar independientemente de las condiciones del mismo. Aún siendo diseñada para su uso en interiores, la madera está tratada para soportar perfectamente el paso del tiempo en cuanto a rigidez y durabilidad del color.

 The hardwood is the material used in the production of this collection. The contemporary style and the material used, provide solutions to numerous decorations where you want to get the highest possible degree of integration with the stay. Thanks to its different support, we can install this collection anywhere regardless of the conditions thereof. Even though it is designed for indoor use, the wood is treated to perfectly support age and durability of colour.

 Le bois est le matériel utilisé dans la production de cette collection. Le style contemporain et le matériel utilisé, offre solutions à de nombreuses décorations où vous voulez obtenir le plus haut degré possible d'intégration avec la chambre. Merci à ses supports, nous pouvons installer cette collection à toute type d'installation. Même si il est conçu pour une utilisation en intérieur, le bois est traité pour soutenir parfaitement le temps et la durabilité de la couleur.

Conjuntos madera **ECLIPSE** /
Wood sets **ECLIPSE** /
Kits bois **ECLIPSE**

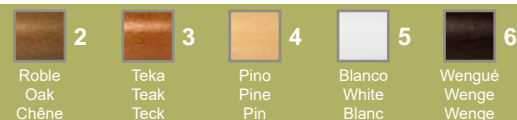

Cilindro Roble, Teka y Pino / Cilindro Oak, Teak and Pine / Cilindro Chêne, Teck et Pin

		Ø 19 REF K.901	Ø 30 REF K.911	Ø 19/19 REF K.921	Ø 30/19 REF K.931		
	1	24,47 €	31,73 €	42,17 €	51,78 €	12	120
Roble / Oak / Chêne							
	1	28,25 €	37,57 €	49,74 €	61,41 €	16	160
Teka / Teak / Teck							
	1	40,35 €* 48,56 €	53,72 €* 66,03 €	70,56 €* 86,98 €	87,45 €* 107,97 €	24* 32	240* 320
Pino / Pine / Pin							

Cilindro Blanco / Cilindro White / Cilindro Blanc

		Ø 19 REF K.901	Ø 30 REF K.911	Ø 19/19 REF K.921	Ø 30/19 REF K.931		
	1	32,01 €	39,56 €	56,06 €	66,42 €	12	120
Blanco / White / Blanc							
	1	37,88 €	47,75 €	67,80 €	80,47 €	16	160
	1	48,76 €	55,96 €	85,59 €	101,71 €	20	200
	1	54,61 €* 67,01 €	68,86 €* 85,81 €	97,28 €* 122,08 €	115,74 €* 145,09 €	24* 32	240* 320

Cilindro Wengué / Cilindro Wenge / Cilindro Wenge

		Ø 19 REF K.901	Ø 30 REF K.911	Ø 19/19 REF K.921	Ø 30/19 REF K.931		
	1	25,36 €	33,06 €	43,96 €	54,01 €	12	120
Wengué / Wenge / Wenge							
	1	29,45 €	39,39 €	52,13 €	64,42 €	16	160
	1	38,06 €	45,74 €	65,98 €	81,55 €	20	200
	1	42,12 €* 50,95 €	56,44 €* 69,66 €	74,11 €* 91,77 €	91,94 €* 113,99 €	24* 32	240* 320



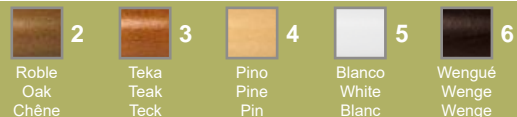

Conjuntos madera ECLIPSE /
Wood sets ECLIPSE /
Kits bois ECLIPSE



Cono Roble, Teka y Pino / Cono Oak, Teak and Pine / Cono Chêne, Teck et Pin

		Ø 19 REF K.902	Ø 30 REF K.912	Ø 19/19 REF K.922	Ø 30/19 REF K.932		
 Roble / Oak / Chêne	1	24,47 €	33,38 €	42,17 €	53,43 €	12	120
 Teka / Teak / Teck	1	28,25 €	39,23 €	49,74 €	63,06 €	16	160
 Pino / Pine / Pin	1	36,57 €	45,12 €	62,99 €	79,43 €	20	200
	1	40,35 €* 48,56 €	55,38 €* 67,68 €	70,56 €* 86,98 €	89,11 €* 109,62 €	24* 32	240* 320

Cono Blanco / Cono White / Cono Blanc

		Ø 19 REF K.902	Ø 30 REF K.912	Ø 19/19 REF K.922	Ø 30/19 REF K.932		
 Blanco / White / Blanc	1	32,01 €	41,54 €	56,06 €	68,39 €	12	120
	1	37,88 €	49,73 €	67,80 €	82,45 €	16	160
	1	48,76 €	57,94 €	85,59 €	103,69 €	20	200
	1	54,61 €* 67,01 €	70,84 €* 87,79 €	97,28 €* 122,08 €	117,72 €* 147,07 €	24* 32	240* 320

Cono Wengué / Cono Wenge / Cono Wenge

		Ø 19 REF K.902	Ø 30 REF K.912	Ø 19/19 REF K.922	Ø 30/19 REF K.932		
 Wengué / Wenge / Wenge	1	25,36 €	34,72 €	43,96 €	55,66 €	12	120
	1	29,45 €	41,04 €	52,13 €	66,08 €	16	160
	1	38,06 €	47,40 €	65,98 €	83,20 €	20	200
	1	42,12 €* 50,95 €	58,09 €* 71,32 €	74,11 €* 91,77 €	93,59 €* 115,65 €	24* 32	240* 320

ECLIPSE

Conjuntos madera **ECLIPSE** /
Wood sets **ECLIPSE** /
Kits bois **ECLIPSE**

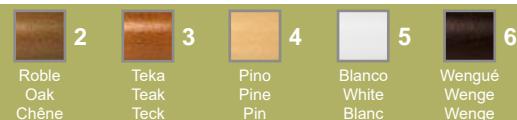

Olimpo Roble, Teka y Pino / Olimpo Oak, Teak and Pine / Olimpo Chêne, Teck et Pin

		Ø 19 REF K.903	Ø 30 REF K.913	Ø 19/19 REF K.923	Ø 30/19 REF K.933		
 Roble / Oak / Chêne	1	24,47 €	32,74 €	42,17 €	52,79 €	12	120
 Teka / Teak / Teck	1	28,25 €	38,54 €	49,74 €	62,42 €	16	160
 Pino / Pine / Pin	1	40,35 €* 48,56 €	54,74 €* 67,04 €	70,56 €* 86,98 €	88,46 €* 108,98 €	24* 32	240* 320

Olimpo Blanco / Olimpo White / Olimpo Blanc

		Ø 19 REF K.903	Ø 30 REF K.913	Ø 19/19 REF K.923	Ø 30/19 REF K.933		
 Blanco / White / Blanc	1	32,01 €	40,71 €	56,06 €	67,57 €	12	120
	1	37,88 €	48,90 €	67,80 €	81,62 €	16	160
	1	48,76 €	57,11 €	85,59 €	102,86 €	20	200
	1	54,61 €* 67,01 €	70,01 €* 86,96 €	97,28 €* 122,08 €	116,89 €* 146,24 €	24* 32	240* 320

Olimpo Wengué / Olimpo Wenge / Olimpo Wenge

		Ø 19 REF K.903	Ø 30 REF K.913	Ø 19/19 REF K.923	Ø 30/19 REF K.933		
 Wengué / Wenge / Wenge	1	25,36 €	34,07 €	43,96 €	55,02 €	12	120
	1	29,45 €	40,40 €	52,13 €	65,43 €	16	160
	1	38,06 €	46,75 €	65,98 €	82,56 €	20	200
	1	42,12 €* 50,95 €	57,45 €* 70,67 €	74,11 €* 91,77 €	92,95 €* 115,00 €	24* 32	240* 320

Conjuntos madera ECLIPSE /
Wood sets ECLIPSE /
Kits bois ECLIPSE

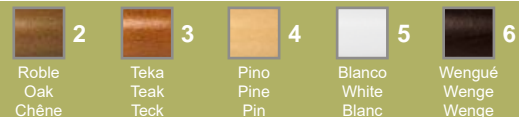

Bola Roble, Teka y Pino / Bola Oak, Teak and Pine / Bola Chêne, Teck et Pin

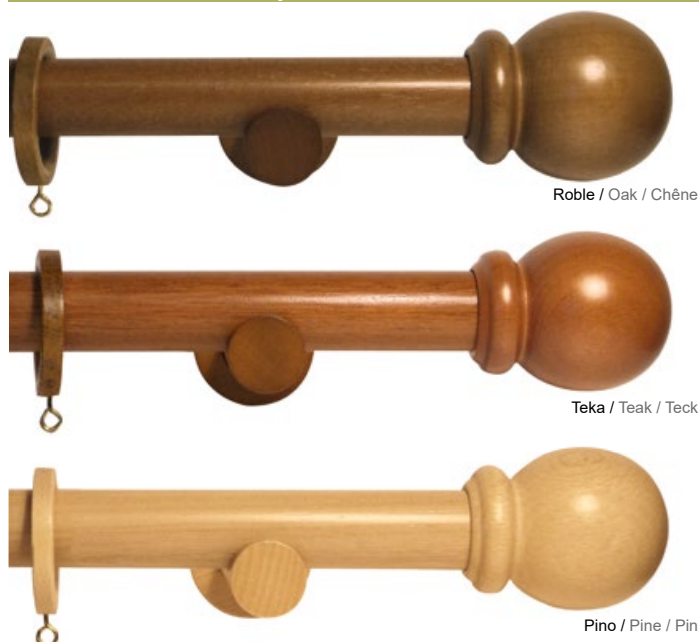

U	Ø 19 REF K.904	Ø 30 REF K.914	Ø 19/19 REF K.924	Ø 30/19 REF K.934	cm	cm
1	24,47 €	34,49 €	42,17 €	54,54 €	12	120
1	28,25 €	40,33 €	49,74 €	64,17 €	16	160
1	36,57 €	46,22 €	62,99 €	80,54 €	20	200
1	40,35 €* 48,56 €	56,48 €* 68,79 €	70,56 €* 86,98 €	90,21 €* 110,73 €	24* 32	240* 320

Bola Blanco / Bola White / Bola Blanc



U	Ø 19 REF K.904	Ø 30 REF K.914	Ø 19/19 REF K.924	Ø 30/19 REF K.934	cm	cm
1	32,01 €	42,60 €	56,06 €	69,45 €	12	120
1	37,88 €	50,78 €	67,80 €	83,51 €	16	160
1	48,76 €	59,00 €	85,59 €	104,74 €	20	200
1	54,61 €* 67,01 €	71,90 €* 88,84 €	97,28 €* 122,08 €	118,78 €* 148,13 €	24* 32	240* 320

Bola Wengué / Bola Wenge / Bola Wenge



U	Ø 19 REF K.904	Ø 30 REF K.914	Ø 19/19 REF K.924	Ø 30/19 REF K.934	cm	cm
1	25,36 €	35,82 €	43,96 €	56,77 €	12	120
1	29,45 €	42,15 €	52,13 €	67,18 €	16	160
1	38,06 €	48,50 €	65,98 €	84,31 €	20	200
1	42,12 €* 50,95 €	59,20 €* 72,42 €	74,11 €* 91,77 €	94,70 €* 116,75 €	24* 32	240* 320

Contenido del Kit / Kit components / Composants du Kit



Conjuntos Sencillos: 2 terminales, 2 soportes, barra y anillas.
 Single sets: 2 finials, 2 brackets, pole & rings.
 Kits simples: 2 embouts, 2 supports, tube et aneaux.

Indique en su pedido el acabado y la medida de la barra que desea.
 When ordering, please specify finish and size of pole.
 Merci de spécifier la finition et la taille de la barre.

Conjunto Doble: 4 terminales, 4 soportes, 2 barra y anillas.
 Single sets: 4 finials, 4 brackets, 2 pole & rings.
 Kits simples: 4 embouts, 4 supports, 2 tube et aneaux.

Ø 30: Los conjuntos superiores a 2 m llevan 3 soportes.
 All sets with length longer than 2 m are supplied with 3 brackets.
 Tous les kits de mesures supérieures à 2 m contiennent 3 supports.

*** A partir de 2,40 metros,** las barras se sirven en dos mitades.
 En el Precio está incluida la pieza de empalme.
 * From 2.4 m, poles are supplied in 2 halves and one joining screw to that purpose included in the price.
 * À partir de 2.4 m, les barres sont fournies in 2 parties et un vis d'union à cette fin inclus dans le prix.

Ø 19: Los conjuntos superiores a 1,6 m llevan 3 soportes.
 All sets with length longer than 1,6 m are supplied with 3 brackets.
 Tous les kits de mesures supérieures à 1,6 m contiennent 3 supports.

Accesorios / Accessories / Accessoires

Cilindro

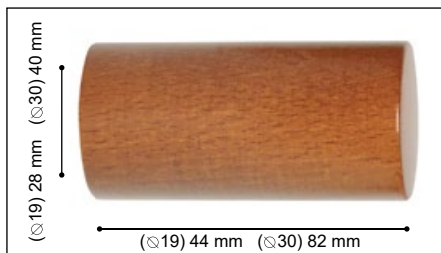

REF	Ø				
P.301192	19	10	1,76 €	2,02 €	
P.301193	19	10	1,76 €	2,02 €	
P.301194	19	10	1,76 €	2,02 €	
P.301195	19	10	1,90 €	2,19 €	
P.301196	19	10	1,76 €	2,02 €	
P.301302	30	10	2,34 €	2,69 €	
P.301303	30	10	2,34 €	2,69 €	
P.301304	30	10	2,34 €	2,69 €	
P.301305	30	10	2,44 €	2,81 €	
P.301306	30	10	2,34 €	2,69 €	

Cono

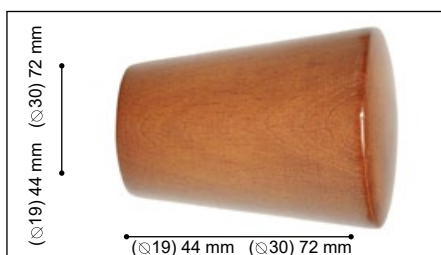

REF	Ø				
P.302192	19	10	1,76 €	2,02 €	
P.302193	19	10	1,76 €	2,02 €	
P.302194	19	10	1,76 €	2,02 €	
P.302195	19	10	1,90 €	2,19 €	
P.302196	19	10	1,76 €	2,02 €	
P.302302	30	10	3,06 €	3,52 €	
P.302303	30	10	3,06 €	3,52 €	
P.302304	30	10	3,06 €	3,52 €	
P.302305	30	10	3,30 €	3,80 €	
P.302306	30	10	3,06 €	3,52 €	

Olimpo

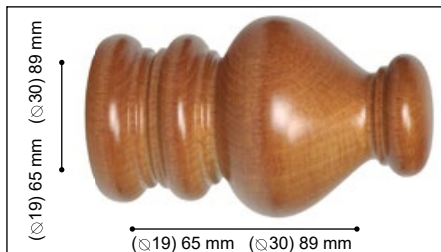

REF	Ø				
P.303192	19	10	1,76 €	2,02 €	
P.303193	19	10	1,76 €	2,02 €	
P.303194	19	10	1,76 €	2,02 €	
P.303195	19	10	1,90 €	2,19 €	
P.303196	19	10	1,76 €	2,02 €	
P.303302	30	10	2,78 €	3,20 €	
P.303303	30	10	2,78 €	3,20 €	
P.303304	30	10	2,78 €	3,20 €	
P.303305	30	10	2,94 €	3,38 €	
P.303306	30	10	2,78 €	3,20 €	

Accesorios / Accessories / Accessoires

Bola

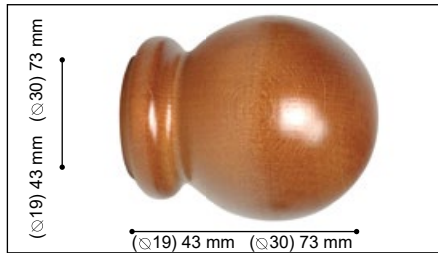

REF	∅	U	€	€	cm
P.304192	19	10	1,76 €	2,02 €	
P.304193	19	10	1,76 €	2,02 €	
P.304194	19	10	1,76 €	2,02 €	
P.304195	19	10	1,90 €	2,19 €	
P.304196	19	10	1,76 €	2,02 €	
P.304302	30	10	3,54 €	4,07 €	
P.304303	30	10	3,54 €	4,07 €	
P.304304	30	10	3,54 €	4,07 €	
P.304305	30	10	3,76 €	4,32 €	
P.304306	30	10	3,54 €	4,07 €	

Anilla Madera Plana

Ring / Anneau



REF	∅	U	€	€	cm
H.204192	19	200	0,228 €	0,274 €	
H.204193	19	200	0,228 €	0,274 €	
H.204194	19	200	0,228 €	0,274 €	
H.204195	19	200	0,60 €	0,72 €	
H.204196	19	200	0,228 €	0,274 €	
H.204302	30	200	0,36 €	0,43 €	
H.204303	30	200	0,36 €	0,43 €	
H.204304	30	200	0,36 €	0,43 €	
H.204305	30	200	0,78 €	0,90 €	
H.204306	30	200	0,36 €	0,43 €	

Soporte Madera Cilindro

Bracket / Support

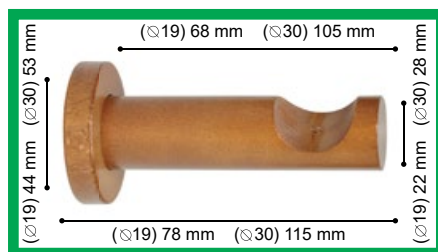

* Soporte incluido en el Kit Sencillo /
Bracket supplied in the Single Kit /
Support fourni dans le Simple Kit

REF	∅	U	€	€	cm
N.700192	19	10	3,94 €	4,53 €	
N.700193	19	10	3,94 €	4,53 €	
N.700194	19	10	3,94 €	4,53 €	
N.700195	19	10	4,36 €	5,01 €	
N.700196	19	10	3,94 €	4,53 €	
N.700302	30	10	3,80 €	4,37 €	
N.700303	30	10	3,80 €	4,37 €	
N.700304	30	10	3,80 €	4,37 €	
N.700305	30	10	4,10 €	4,72 €	
N.700306	30	10	3,80 €	4,37 €	

Soporte Madera Cilindro Doble

Double bracket / Support double

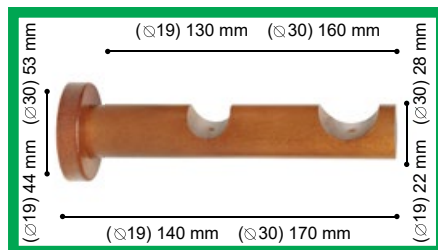

* Soporte incluido en el Kit Doble /
Bracket supplied in the Double Kit /
Support fourni dans le Double Kit.

REF	∅	U	€	€	cm
O.711192	19/ 19	10	4,94 €	5,68 €	
O.711193	19/ 19	10	4,94 €	5,68 €	
O.711194	19/ 19	10	4,94 €	5,68 €	
O.711195	19/ 19	10	5,26 €	6,05 €	
O.711196	19/ 19	10	4,94 €	5,68 €	
O.713192	30/ 19	10	5,82 €	6,69 €	
O.713193	30/ 19	10	5,82 €	6,69 €	
O.713194	30/ 19	10	5,82 €	6,69 €	
O.713195	30/ 19	10	6,22 €	7,15 €	
O.713196	30/ 19	10	5,82 €	6,69 €	

Codo Madera

Elbow /
Coude

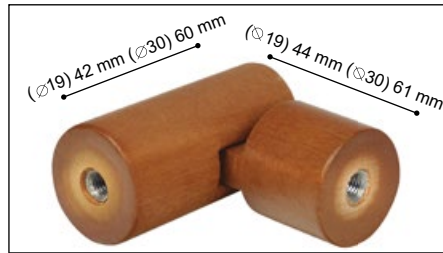

REF	∅				
H.262	19	1		7,32 €	
H.263	19	1		7,32 €	
H.264	19	1		7,32 €	
H.265	19	1		7,74 €	
H.266	19	1		7,32 €	
H.252	30	1		8,04 €	
H.253	30	1		8,04 €	
H.254	30	1		8,04 €	
H.255	30	1		8,44 €	
H.256	30	1		8,04 €	

Soporte Madera
Cilindro Techo

Ceiling Bracket /
Support plafond



REF	∅				
N.701192	19	10	7,10 €	8,17 €	
N.701193	19	10	7,10 €	8,17 €	
N.701194	19	10	7,10 €	8,17 €	
N.701195	19	10	7,96 €	9,15 €	
N.701196	19	10	7,10 €	8,17 €	
N.701302	30	10	8,08 €	9,29 €	
N.701303	30	10	8,08 €	9,29 €	
N.701304	30	10	8,08 €	9,29 €	
N.701305	30	10	8,74 €	10,05 €	
N.701306	30	10	8,08 €	9,29 €	

Soporte Madera
Dintel

Recess bracket /
Support naissance

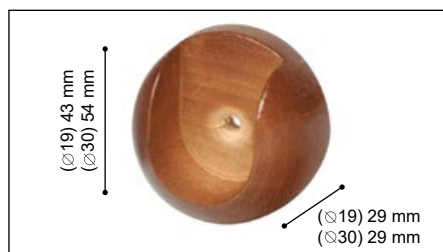

REF	∅				
N.704192	19	10	1,96 €	2,25 €	
N.704193	19	10	1,96 €	2,25 €	
N.704194	19	10	1,96 €	2,25 €	
N.704195	19	10	2,08 €	2,39 €	
N.704196	19	10	1,96 €	2,25 €	
N.704302	30	10	2,20 €	2,53 €	
N.704303	30	10	2,20 €	2,53 €	
N.704304	30	10	2,20 €	2,53 €	
N.704305	30	10	2,40 €	2,76 €	
N.704306	30	10	2,20 €	2,53 €	

Soporte madera

Bracket /
Support

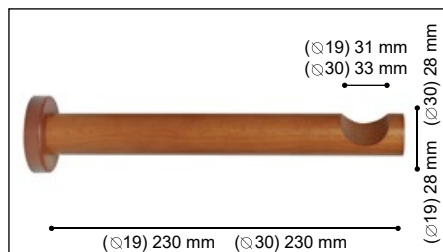

REF	∅				
N.702192	19	10	5,68 €	6,53 €	
N.702193	19	10	5,68 €	6,53 €	
N.702194	19	10	5,68 €	6,53 €	
N.702195	19	10	6,04 €	6,95 €	
N.702196	19	10	5,68 €	6,53 €	
N.702302	30	10	5,68 €	6,53 €	
N.702303	30	10	5,68 €	6,53 €	
N.702304	30	10	5,68 €	6,53 €	
N.702305	30	10	6,04 €	6,95 €	
N.702306	30	10	5,68 €	6,53 €	

Accesorios / Accessories / Accessoires

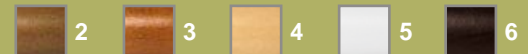

Soporte Madera
Techo Doble

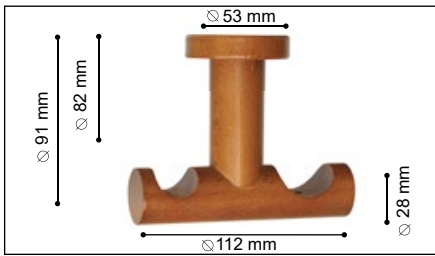

Double ceiling
bracket /
Support double
plafond

REF	∅	U	€	€ ¹	cm
O.723192	30/19	10	8,68 €	9,98 €	
O.723193	30/19	10	8,68 €	9,98 €	
O.723194	30/19	10	8,68 €	9,98 €	
O.723195	30/19	10	9,70 €	11,16 €	
O.723196	30/19	10	8,68 €	9,98 €	

Soporte Madera
Clásico 19 mm

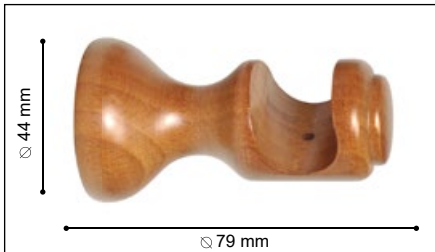

Bracket Classic /
Support Classique

REF	∅	U	€	€ ¹	cm
N.900192	19	10	3,00 €	3,45 €	
N.900193	19	10	3,00 €	3,45 €	
N.900194	19	10	3,00 €	3,45 €	
N.900195	19	10	3,16 €	3,63 €	
N.900196	19	10	3,00 €	3,45 €	

Soporte Madera
Clásico 30 mm



Bracket Classic /
Support Classique

REF	∅	U	€	€ ¹	cm
N.900302	30	10	5,14 €	5,91 €	
N.900303	30	10	5,14 €	5,91 €	
N.900304	30	10	5,14 €	5,91 €	
N.900305	30	10	5,44 €	6,26 €	
N.900306	30	10	5,14 €	5,91 €	

Soporte Madera
Clásico 19 mm
a Techo

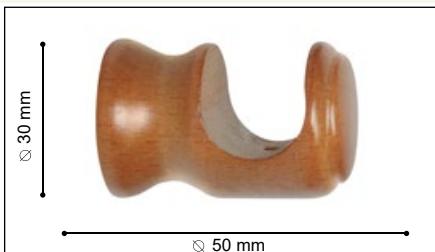

Bracket Ceiling
Classic /
Supportau
plafond Classique

REF	∅	U	€	€ ¹	cm
N.901192	19	10	2,64 €	3,04 €	
N.901193	19	10	2,64 €	3,04 €	
N.901194	19	10	2,64 €	3,04 €	
N.901195	19	10	2,76 €	3,17 €	
N.901196	19	10	2,64 €	3,04 €	

Soporte Madera
Clásico 30 mm
a Techo

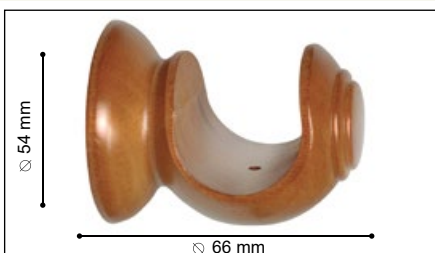

Bracket Ceiling
Classic /
Supportau plafond
Classique

REF	∅	U	€	€ ¹	cm
N.901302	30	10	3,96 €	4,55 €	
N.901303	30	10	3,96 €	4,55 €	
N.901304	30	10	3,96 €	4,55 €	
N.901305	30	10	4,20 €	4,83 €	
N.901306	30	10	3,96 €	4,55 €	

Tirador madera
1 m

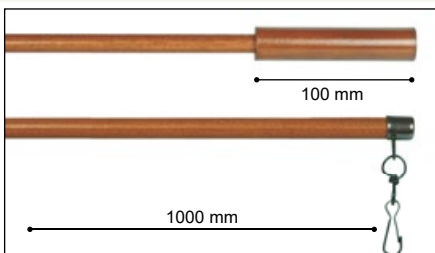

Wand /
Bâton

REF	∅	U	€	€ ¹	cm
L.22		1		7,84 €	100
L.23		1		7,84 €	100
L.24		1		7,84 €	100
L.25		1		8,76 €	100
L.26		1		7,84 €	100

Barra color Roble

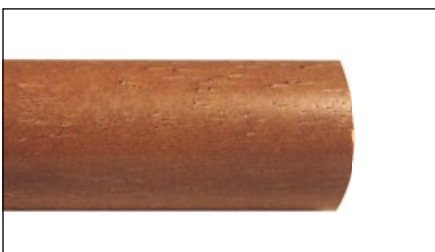

Oak Color Pole /
Tringle
Couleur Chêne

REF	∅	U	€	€ ¹	cm
G.219120	19	10	7,02 €	8,07 €	120
G.219160	19	10	9,36 €	10,76 €	160
G.219200	19	10	11,70 €	13,46 €	200
G.219240	19	10	14,04 €	16,15 €	240
G.230120	30	10	10,80 €	12,42 €	120
G.230160	30	10	14,38 €	16,54 €	160
G.230200	30	10	18,00 €	20,70 €	200
G.230240	30	10	21,62 €	24,86 €	240

Barras Clásicas
Portavisillos

Barra color Teka

Teak Color Pole /
Tringle
Couleur Teck



REF	∅				
G.319120	19	10	7,02 €	8,07 €	120
G.319160	19	10	9,36 €	10,76 €	160
G.319200	19	10	11,70 €	13,46 €	200
G.319240	19	10	14,04 €	16,15 €	240
G.330120	30	10	10,80 €	12,42 €	120
G.330160	30	10	14,38 €	16,54 €	160
G.330200	30	10	18,00 €	20,70 €	200
G.330240	30	10	21,62 €	24,86 €	240

Barra color Pino

pine Color Pole /
Tringle
Couleur Pin



REF	∅				
G.419120	19	10	7,02 €	8,07 €	120
G.419160	19	10	9,36 €	10,76 €	160
G.419200	19	10	11,70 €	13,46 €	200
G.419240	19	10	14,04 €	16,15 €	240
G.430120	30	10	10,80 €	12,42 €	120
G.430160	30	10	14,38 €	16,54 €	160
G.430200	30	10	18,00 €	20,70 €	200
G.430240	30	10	21,62 €	24,86 €	240

Barra color Blanco

White Color Pole /
Tringle
Couleur Blanc

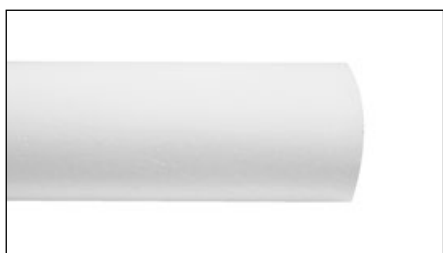

REF	∅				
G.519120	19	10	7,80 €	8,97 €	120
G.519160	19	10	10,40 €	11,96 €	160
G.519200	19	10	13,00 €	14,95 €	200
G.519240	19	10	15,58 €	17,92 €	240
G.530120	30	10	11,96 €	13,75 €	120
G.530160	30	10	15,96 €	18,35 €	160
G.530200	30	10	19,98 €	22,98 €	200
G.530240	30	10	23,98 €	27,58 €	240

Barra color Wengué

Wenge Color Pole /
Tringle
Couleur Wenge



REF	∅				
G.619120	19	10	7,80 €	8,97 €	120
G.619160	19	10	10,40 €	11,96 €	160
G.619200	19	10	13,00 €	14,95 €	200
G.619240	19	10	15,58 €	17,92 €	240
G.630120	30	10	11,96 €	13,75 €	120
G.630160	30	10	15,96 €	18,35 €	160
G.630200	30	10	19,98 €	22,98 €	200
G.630240	30	10	23,98 €	27,58 €	240



Dowell de Empalme
60 mm x 5 mm

Joining Dowell /
Dowell raccordeur

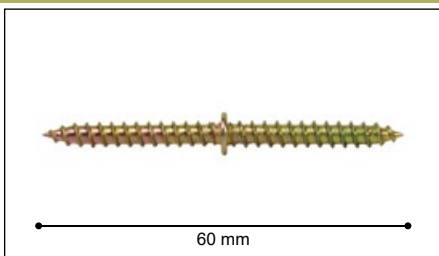

REF	∅	U	€	€	cm
V.58		100	0,64 €	0,73 €	

Expositor
ECLIPSE

ECLIPSE
Display Board /
Presentoir
ECLIPSE



REF	∅	U	€	€	cm
M.209		1		43,88 €	



Decoration with a different "touch"
Decorando con un toque diferente

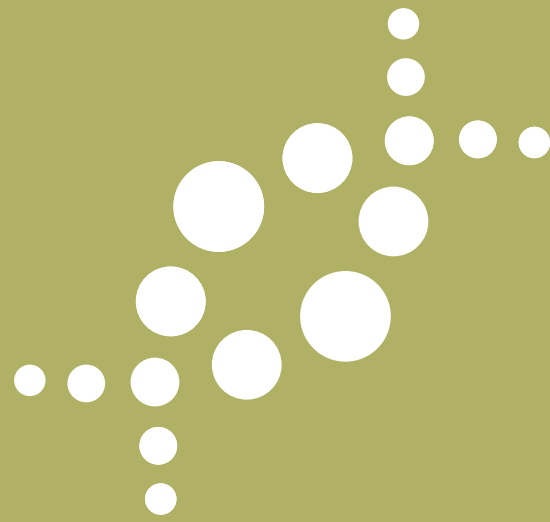

ALTRAN[®]

CURTAIN DECORATION SYSTEMS

Frankfurt Ø8mm



Blanco
White / Blanc

Café Ø12 mm



Latón
Brass/ Laiton



Blanco
White / Blanc

Berlín Ø10 mm



Blanco
White / Blanc

Bonn Ø8 mm



Negro Óxido
Black-Rust/Noir-roui llé



Negro Oro
Black-Gold/Noir-Or



Negro
Black / Noir

Praga Ø9 mm



Acero
Steel / Acier



Negro
Black / Noir



Latón
Brass/ Laiton



Blanco
White / Blanc

Portavisillos / Net Curtain Rod / Petit Tringles

Frankfurt Ø 8 mm - Portavisillo Extensible / Extendible Net Rod / Petite Tringle Extensible



REF				
F.519BL	10	1,72 €	1,98 €	18-30
F.520BL	10	1,88 €	2,16 €	30-55
F.521BL	10	2,52 €	2,90 €	53-95

Café Ø 12 mm - Portavisillo Extensible / Extendible Net Rod / Petite Tringle Extensible



REF				
F.300	10	4,94 €	5,68 €	50-85
F.301	10	5,96 €	6,85 €	75-135
F.302	10	7,78 €	8,95 €	125-235
F.310	10	5,60 €	6,44 €	50-85
F.311	10	6,82 €	7,84 €	75-135
F.312	10	8,98 €	10,33 €	125-235

Soporte
Café

Bracket /
Support



REF	Ø				
F.3		50	0,68 €	0,78 €	
F.4		50	0,46 €	0,55 €	

*Soporte incluido en el Kit / Bracket included in the Kit / Support inclus dans le Kit

Berlín Ø 10 mm - Portavisillo Extensible / Extendible Net Rod / Petite Tringle Extensible



REF				
F.104	25	0,84 €	0,97 €	40-70
F.106	25	1,20 €	1,38 €	60-110
F.108	25	1,50 €	1,73 €	80-150

*Se suministra con Alcañas / Supplied with 2 Hooks / Fourni avec 2 Clous

Soporte
Autoadhesivo
Berlín

Self-adhesive
Bracket /
Support Adhesif



REF	Ø				
F.1		100	0,432 €	0,518 €	

Portavisillos / Net Curtain Rod / Petit Tringles

Bonn Ø 8 mm - Portavisillo Extensible Forja / Wrought iron finish Extendible Net curtain Rod / Tringle Extensible fer forgé



REF				
F.004N	50	1,60 €	1,84 €	40-70
F.006N	50	2,20 €	2,53 €	60-110
F.008N	50	2,74 €	3,15 €	80-150
F.004NO	50	1,92 €	2,21 €	40-70
F.006NO	50	2,64 €	3,04 €	60-110
F.008NO	50	3,28 €	3,77 €	80-150
F.004OX	50	1,92 €	2,21 €	40-70
F.006OX	50	2,64 €	3,04 €	60-110
F.008OX	50	3,28 €	3,77 €	80-150

*Se sirve con Alcapuztas / Supplied with 2 Hooks / Fourni avec 2 Clous

Soporte
Autoadhesivo
Bonn

Self-adhesive
Bracket/
Support adhesif



REF	∅				
F.1N		100	0,44 €	0,53 €	
F.1NO		100	0,52 €	0,62 €	
F.1OX		100	0,52 €	0,62 €	

Praga Ø 9 mm - Portavisillo Extensible / Extendible Net curtain Rod / Tringle Extensible

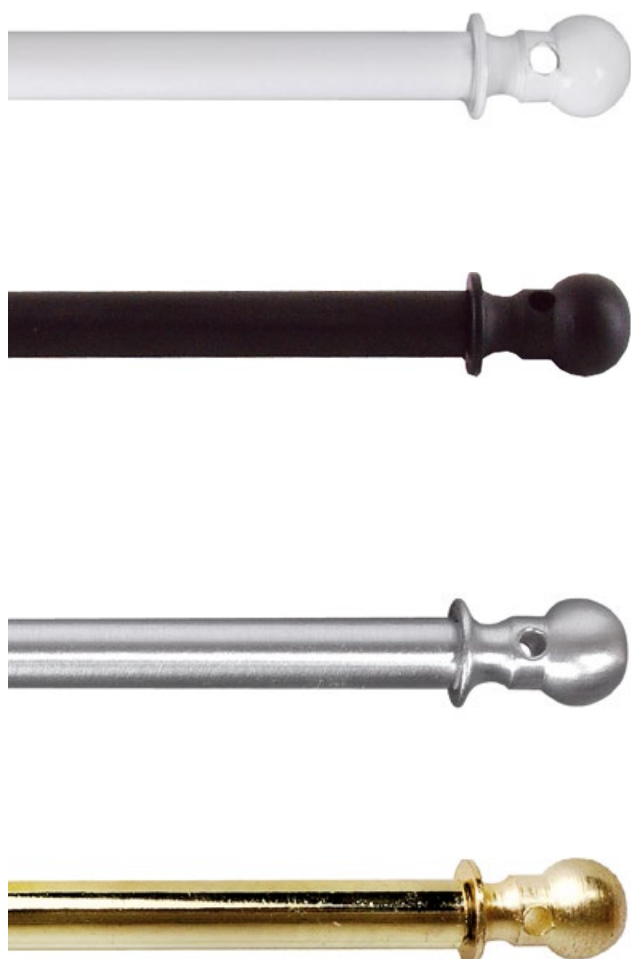

REF				
F.525BL	10	4,02 €	4,62 €	25-40
F.540BL	10	5,22 €	6,00 €	40-70
F.560BL	10	5,96 €	6,85 €	60-110
F.580BL	10	7,68 €	8,83 €	80-150
F.525N	10	4,02 €	4,62 €	25-40
F.540N	10	5,22 €	6,00 €	40-70
F.560N	10	5,96 €	6,85 €	60-110
F.580N	10	7,68 €	8,83 €	80-150
F.525A	10	5,02 €	5,77 €	25-40
F.540A	10	6,74 €	7,75 €	40-70
F.560A	10	9,10 €	10,47 €	60-110
F.580A	10	10,50 €	12,08 €	80-150
F.525LA	10	5,02 €	5,77 €	25-40
F.540LA	10	6,74 €	7,75 €	40-70
F.560LA	10	9,10 €	10,47 €	60-110
F.580LA	10	10,50 €	12,08 €	80-150

*Se sirve con Alcapuztas / Supplied with 2 Hooks / Fourni avec 2 Clous

Accesorios / Accessories / Accessoires

Soporte metálico
Autoadhesivo

Metallic Adhesive
Bracket /
Support Metal Adhesive



REF	∅				
F.6BL		100	0,92 €	1,06 €	
F.6N		100	0,92 €	1,06 €	
F.6A		100	0,96 €	1,10 €	
F.6PL		100	0,96 €	1,10 €	
F.6LA		100	0,96 €	1,10 €	

Soporte
Autoadhesivo

Self-adhesive
Bracket /
Support Adhesive



REF	∅				
F.2		100	0,84 €	0,97 €	

Barra de Baño / Shower Curtain Rod / Rideau de Douche

Barra de baño
extensible

Extensible shower
curtain rod /
Barre extensible
pour rideau de douche



REF	∅				
E.01BL		10	10,66 €	12,26 €	75 - 120
E.02BL		10	15,50 €	17,83 €	130 - 240

Galerías

pelmet / cantonnières

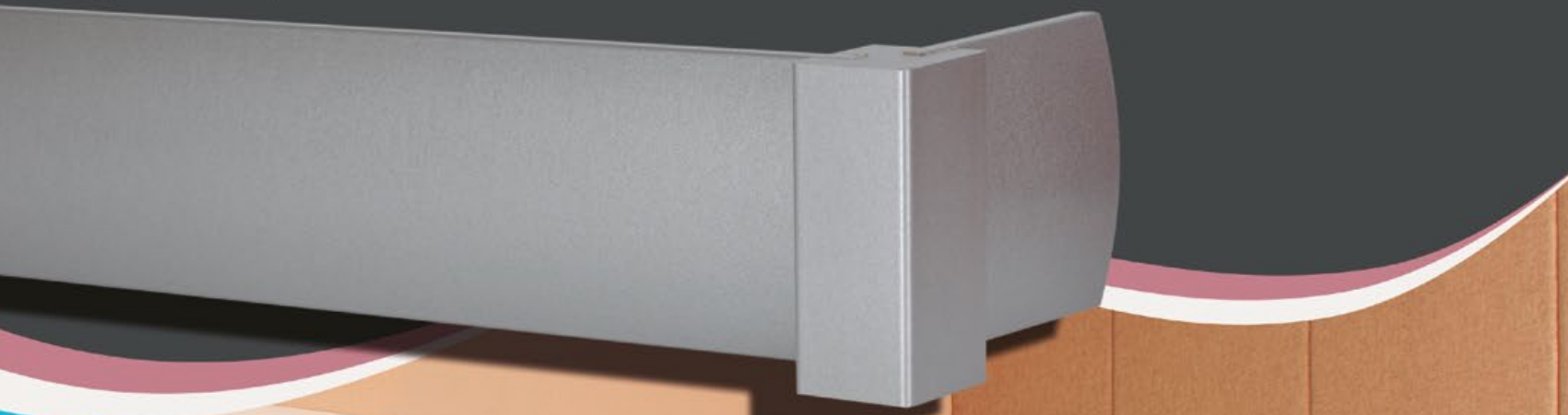



GALERÍAS
COLORSYSTEM
PELMETS



ALTRAN[®]
SISTEMAS PARA DECORAR CORTINAS

ColorSystem COLOR

Sin separador /

Without divider-bar / Sans barre de séparation



Blanco / White / Blanc



Beige / Beige / Beige



Amarillo / Yellow / Jaune



Naranja / Orange / Orange



Rojo / Red / Rouge

Con separador /

With divider-bar / Avec barre de séparation



Azul / Blue / Bleu



Violeta / Violet / Violet



Verde / Green / Vert



Negro / Black / Noir

ColorSystem LISA

12 cm. Lisa /
12 cm. Plain / 12 cm. Lisse



Champagne / Champagne / Champagne

ColorSystem METAL

Sin separador / Without divider-bar / Sans séparation



Inox / Inox / Inox



Ondas / Waves / Ondes

Con separador / With divider-bar / Avec séparation



Inox / Inox / Inox



Ondas / Waves / Ondes

ColorSystem MADERA

Sin separador /
Without divider-bar / Sans barre de séparation



Roble/ Oak / Chêne



Cebrano claro / Light zebano / Zebrano clair



Cebrano oscuro / Dark zebano / Zebrano sombre

Con separador / With divider-bar / Avec séparation



Wengué / Wenge / Wenge



Cerezo / Cherri / Merisier

Conjuntos completos ColorSgt em LISA 12cm /
 Complet sets ColorSgt em PLAIN 12cm /
 Kits complete ColorSgt em LISSE 12cm

X AP
 Champagne Champagne Champagne
 Aluminio Aluminium Aluminium

Galería ColorSgt em 12cm Champagne Lisa / ColorSgt em Pelmet 12 cm Plain Champagne / Cantonnière ColorSgt em 12cm Champagne Lisse



REF	U	€	cm
K.33100X	1	45,06 €	100
K.33150X	1	56,58 €	150
K.33200X	1	70,53 €	200
K.33250X	1	82,04 €	250
K.33300X	1	95,99 €	300
K.33350X	1	117,50 €	350
K.33400X	1	129,01 €	400
K.33450X	1	140,53 €	450
K.33500X	1	152,04 €	500
K.33550X	1	163,55 €	550
K.33600X	1	179,94 €	600

Galería ColorSgt em 12cm Aluminio Lisa / ColorSgt em Pelmet 12 cm Plain Aluminium / Cantonnière ColorSgt em 12cm Aluminium Lisse



REF	U	€	cm
K.33100AP	1	36,18 €	100
K.33150AP	1	45,00 €	150
K.33200AP	1	56,26 €	200
K.33250AP	1	65,08 €	250
K.33300AP	1	76,34 €	300
K.33350AP	1	94,22 €	350
K.33400AP	1	103,04 €	400
K.33450AP	1	111,86 €	450
K.33500AP	1	120,68 €	500
K.33550AP	1	129,50 €	550
K.33600AP	1	143,20 €	600

Contenido del Kit / Kit components / Composants du Kit

 **Nota:** incluye 2 u eltas de 15 cm incluidas en el precio.
 A partir de 3 m las galerías se empalmadas.
 Se debe proporcionar la medida exterior.
 La medida exterior es igual a la superficie que necesita cubrir más 4 cm mínimo adicionales.
 (4 cm = 1,7 cm x 2 de codos y/o esquinas + espacio para trabajar).

 **Note:** included 2 side returns of 15 cm in price.
 For sizes more than 3 m pelmets are spliced.
 Sizes required are outer measures.
 The outer measure is equal to the area you need to cover plus 4 cm minimum.
 (4 cm = 1.7 cm x 2 elbows and / or corners + workspace).

 **Remarque:** le prix inclu 2 retours latéraux de 15 cm.
 Pour les tailles plus de 3 m les cantonnières sont fournies en deux parties avec raccordeur. Tailles nécessaires sont des mesures extérieures. La mesure extérieure est égale à la surface dont vous avez besoin pour couvrir plus un minimum de 4 cm.
 (4 cm = 1,7 cm x 2 coudes et / ou des coins + espace de travail).

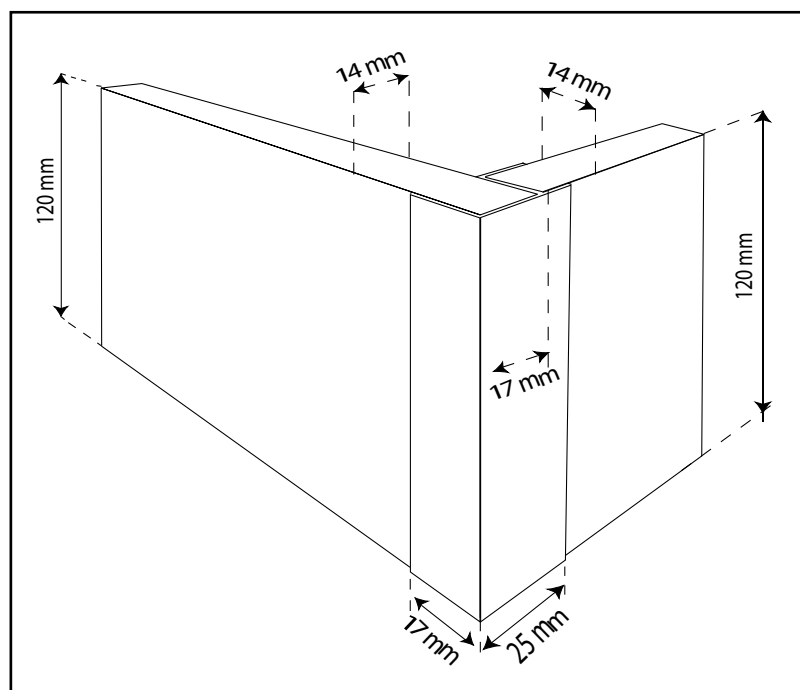

Conjuntos completos ColorSystem 12cm /
 Complet sets ColorSystem COLOR 12 cm /
 Kits complete ColorSystem COLOR 12 cm



Galería ColorSyst em SIN Separador / ColorSystem Pelmet WITHOUT div der-bar / Cantonnière ColorSyst em SANS séparation



REF	U	€	cm
K.31100C	1	48,53 €	100
K.31150C	1	63,35 €	150
K.31200C	1	90,14 €	200
K.31250C	1	100,05 €	250
K.31300C	1	112,39 €	300
K.31350C	1	160,26 €	350
K.31400C	1	170,16 €	400
K.31450C	1	180,06 €	450
K.31500C	1	189,96 €	500
K.31550C	1	199,87 €	550
K.31600C	1	214,64 €	600

Galería ColorSyst em CON Separador / ColorSyst em Pelmet WITH div der-bar / Cantonnière ColorSyst em AVEC séparation



REF	U	€	cm
K.32100C	1	51,70 €	100
K.32150C	1	67,81 €	150
K.32200C	1	96,43 €	200
K.32250C	1	107,35 €	250
K.32300C	1	120,70 €	300
K.32350C	1	171,22 €	350
K.32400C	1	182,13 €	400
K.32450C	1	193,04 €	450
K.32500C	1	203,96 €	500
K.32550C	1	214,87 €	550
K.32600C	1	230,66 €	600

Contenido del Kit / Kit components / Composants du Kit



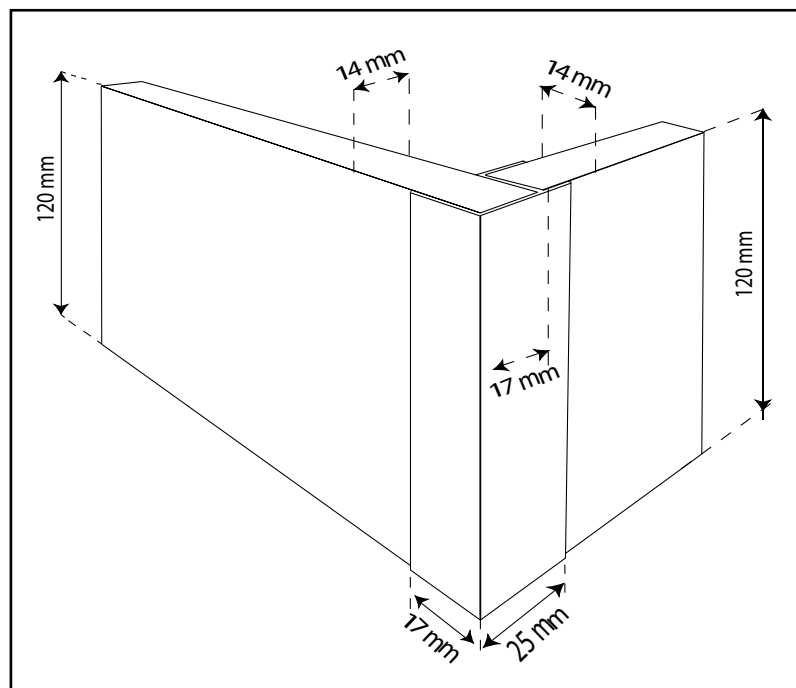

Nota: incluye 2 u eltas de 15 cm incluidas en el precio.
 A partir de 3 m las galerías n empalmadas.
 Se debe proporcionar la medida ek erior.
 La medida exterior es igual a la superficie que necesita cubrir más 4 cm mínimo adicionales.
 (4 cm = 1,7 cm x 2 de codos y/o esquinas + espacio para trabajar).

Note: included 2 side returns of 15 cm in price.
 For siz s more than 3 m pelmets are spliced.
 Sizes required are outer measures.
 The outer measure is equal to the area you need to cover plus 4 cm minimum.
 (4 cm = 1.7 cm x 2 elbows and / or corners + workspace).

Remarque: le prix inclu 2 retours latéraux de 15 cm.
 Pour les tailles plus de 3 m les cantonnières sont fournies en deux parties aec raccordeur. Tailles nécessaires sont des mesu- res ek érieures. La mesure ek érieur est égale à la surface dont v us aez besoin pour couv ir plus un minimum de 4 cm.
 (4 cm = 1,7 cm x 2 coudes et / ou des coins + espace de travail).



Conjuntos completos ColorSyt em **MADERA 12 cm /**
 Complet sets ColorSyt em **WOOD 12 cm /**
 Kits complete ColorSyt em **BOIS 12 cm**

 011	 014	 015	 100	 101
Roble Oak Chêne	Cebrano claro Light & blanco Zebrano llair	Cebrano oscuro Dark & brano Zebrano Sombré	Wengué Wenge Wenge	Cereà Cherry Merisier

Galería ColorSyt em SIN Separador / ColorSyt em Pelmet WITHOUT div der-bar / Cantonnière ColorSyt em SANS séparation



REF			
K.31100M	1	51,91 €	100
K.31150M	1	68,47 €	150
K.31200M	1	100,38 €	200
K.31250M	1	110,28 €	250
K.31300M	1	122,62 €	300
K.31350M	1	180,73 €	350
K.31400M	1	190,63 €	400
K.31450M	1	200,53 €	450
K.31500M	1	210,43 €	500
K.31550M	1	220,34 €	550
K.31600M	1	235,11 €	600

Galería ColorSyt em CON Separador / ColorSyt em Pelmet WITH div der-bar / Cantonnière ColorSyt em AVEC séparation



REF			
K.32100M	1	55,03 €	100
K.32150M	1	72,85 €	150
K.32200M	1	106,51 €	200
K.32250M	1	117,42 €	250
K.32300M	1	130,77 €	300
K.32350M	1	191,36 €	350
K.32400M	1	202,28 €	400
K.32450M	1	213,19 €	450
K.32500M	1	224,11 €	500
K.32550M	1	235,02 €	550
K.32600M	1	250,81 €	600

Contenido del Kit / Kit components / Composants du Kit

 **Nota:** incluye 2 u eltas de 15 cm incluidas en el precio.
 A partir de 3 m las galerías se empalmadas.
 Se debe proporcionar la medida exterior.
 La medida exterior es igual a la superficie que necesita cubrir más 4 cm mínimo adicionales.
 (4 cm = 1,7 cm x 2 de codos y/o esquinas + espacio para trabajar).

 **Note:** included 2 side returns of 15 cm in price.
 For sizes more than 3 m pelmets are spliced.
 Sizes required are outer measures.
 The outer measure is equal to the area you need to cover plus 4 cm minimum.
 (4 cm = 1.7 cm x 2 elbows and / or corners + workspace).

 **Remarque:** le prix inclu 2 retours latéraux de 15 cm.
 Pour les tailles plus de 3 m les cantonnières sont fournies en deux parties avec raccordeur. Tailles nécessaires sont des mesures extérieures. La mesure extérieure est égale à la surface dont vous avez besoin pour couvrir plus un minimum de 4 cm.
 (4 cm = 1,7 cm x 2 coudes et / ou des coins + espace de travail).

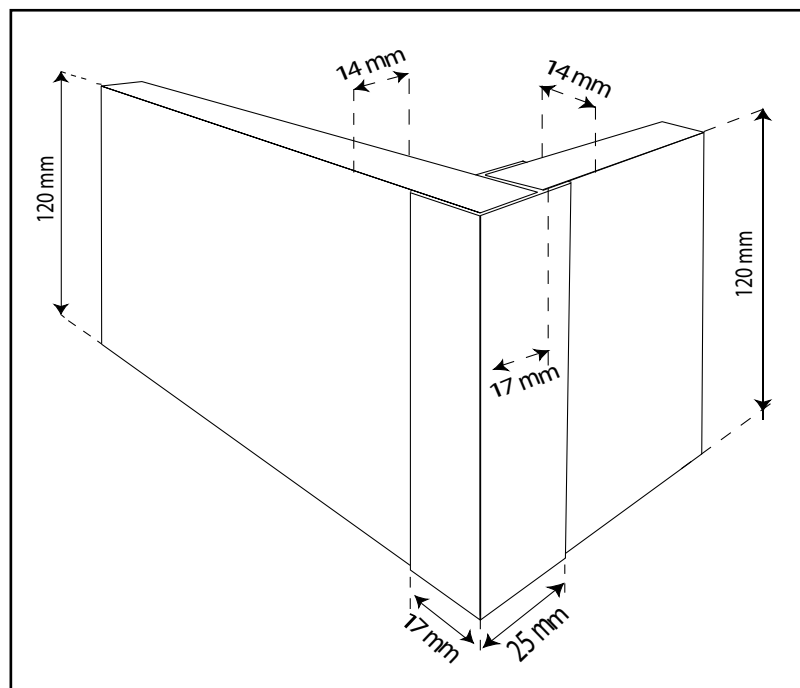

Conjuntos completos ColorSyst ems METAL 12 cm /
 Complet sets ColorSyst em METAL 12 cm /
 Kits complete ColorSyst em METAL 12 cm

016 017
 Inox Ondas
 Inox Wae s
 Ondes

Galería ColorSyst em SIN Separador / ColorSystem Pelmet WITHOUT div der-bar / Cantonnière ColorSyst em SANS séparation



REF	U	€	cm
K.31100A	1	74,60 €	100
K.31150A	1	102,85 €	150
K.31200A	1	169,15 €	200
K.31250A	1	179,05 €	250
K.31300A	1	191,39 €	300
K.31350A	1	318,27 €	350
K.31400A	1	328,17 €	400
K.31450A	1	338,07 €	450
K.31500A	1	347,97 €	500
K.31550A	1	357,88 €	550
K.31600A	1	372,65 €	600

Galería ColorSyst em CON Separador / ColorSyst em Pelmet WITH div der-bar / Cantonnière ColorSyst em AVEC séparation



REF	U	€	cm
K.32100A	1	77,43 €	100
K.32150A	1	106,79 €	150
K.32200A	1	174,40 €	200
K.32250A	1	185,32 €	250
K.32300A	1	198,67 €	300
K.32350A	1	327,16 €	350
K.32400A	1	338,07 €	400
K.32450A	1	348,98 €	450
K.32500A	1	359,90 €	500
K.32550A	1	370,81 €	550
K.32600A	1	386,60 €	600

Contenido del Kit / Kit components / Composants du Kit

Nota: incluye 2 u eltas de 15 cm incluidas en el precio.
 A partir de 3 m las galerías n empalmadas.
 Se debe proporcionar la medida ek erior.
 La medida exterior es igual a la superficie que necesita cubrir más
 4 cm mínimo adicionales.
 (4 cm = 1,7 cm x 2 de codos y/o esquinas + espacio para trabajar).

Note: included 2 side returns of 15 cm in price.
 For siz s more than 3 m pelmets are spliced.
 Sizes required are outer measures.
 The outer measure is equal to the area you need to cover plus
 4 cm minimum.
 (4 cm = 1.7 cm x 2 elbows and / or corners + workspace).

Remarque: le prix inclu 2 retours latéraux de 15 cm.
 Pour les tailles plus de 3 m les cantonnières sont fournies en
 deux parties aec raccordeur. Tailles nécessaires sont des mesu-
 res ek érieures. La mesure ek érieur est égale à la surface dont
 vous aez besoin pour couv ir plus un minimum de 4 cm.
 (4 cm = 1,7 cm x 2 coudes et / ou des coins + espace de travail).

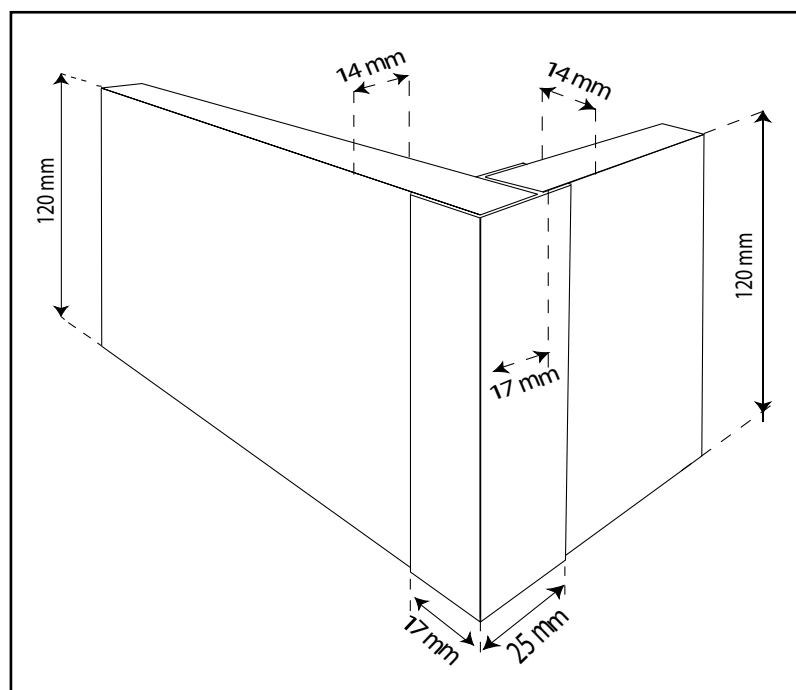

Pefil separador

Div der-bar /
Barre de séparation



REF	∅	U	€	€	cm
C.12028AP		60	1,76 €	2,02 €	

Pefil galería
con separador
12 cm.

Profile with divider-bar
12 cm /
Profil avec canal pour
séparation 12 cm



REF	∅	U	€	€	cm
C.12027AP		60	17,22 €	19,80 €	

Pefil galería
sin separador
Lisa 12 cm.

Profile without
div der-bar 12 cm /
Profil plat sans
canal de séparation
12 cm



REF	∅	U	€	€	cm
C.12026AP		60	15,34 €	17,64 €	
C.12026X		60	20,02 €	23,02 €	

Empalme

Splice /
Raccordeur



REF	∅	U	€	€	cm
G.200AP		10	3,64 €	4,19 €	
G.200X		10	4,46 €	5,13 €	

Esquina

Outer joint /
Coude extérieur

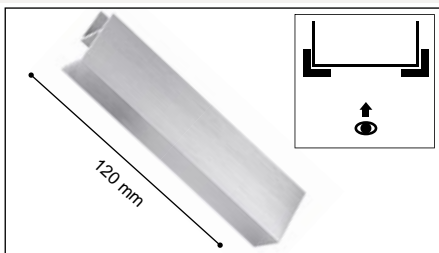

REF	∅	U	€	€	cm
G.201AP		10	3,64 €	4,19 €	
G.201X		10	4,46 €	5,13 €	

Rincón

Inner joint /
Coude intérieur

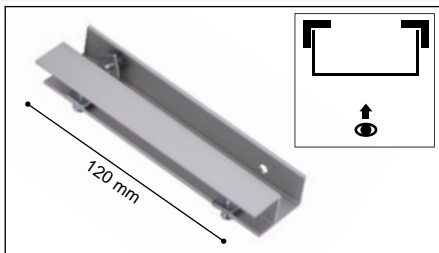

REF	∅	U	€	€	cm
G.202AP		10	3,64 €	4,19 €	
G.202X		10	4,46 €	5,13 €	

Soporte Techo

Ceiling Bracket /
Support Plafond



REF	∅	U	€	€	cm
D.50		50	2,12 €	2,44 €	

* Soporte incluido en el kit / Bracket supplied in the kit / Support fourni dans le kit.

Muestra GALERÍA
Champagne 12 cm
Lisa

PELMET
12 cm Champagne
Plain Sample /
Presentoir Canton-
nière 12 cm plat



REF	∅	U	€	€	cm
M.312		1		11,54 €	

Accesorios / Accessories / Accessoires

Muestra Colores
GALERÍA

PELMET
Color Sample /
Presentoir Colour
Cantonnière



REF	Ø	U	€	1	cm
M.7		1		22,06 €	

Muestra GALERÍA
COLORSYSTEM

PELMET
COLORSYSTEM
Sample /
Presentoir
COLORSYSTEM
Cantonnière



REF	Ø	U	€	1	cm
M.310		1		22,06 €	

Láminas ColorSystem 12 cm COLOR / Bars ColorSystem 12 cm COLOR / Séparation ColorSystem 12 cm COLEUR

COLOR	REF	U	cm	€	1	cm	€	1	cm	€	1
102	V.102C0_	10	115	25,90 €	29,79 €	92	20,32 €	23,37 €	22	7,00 €	8,05 €
000	V.000C0_	10	115	25,14 €	28,91 €	92	19,74 €	22,70 €	22	6,82 €	7,84 €
001	V.001C0_	10	115	25,14 €	28,91 €	92	19,74 €	22,70 €	22	6,82 €	7,84 €
002	V.002C0_	10	115	25,14 €	28,91 €	92	19,74 €	22,70 €	22	6,82 €	7,84 €
004	V.004C0_	10	115	25,14 €	28,91 €	92	19,74 €	22,70 €	22	6,82 €	7,84 €
005	V.005C0_	10	115	25,14 €	28,91 €	92	19,74 €	22,70 €	22	6,82 €	7,84 €
006	V.006C0_	10	115	25,14 €	28,91 €	92	19,74 €	22,70 €	22	6,82 €	7,84 €
010	V.010C0_	10	115	25,14 €	28,91 €	92	19,74 €	22,70 €	22	6,82 €	7,84 €
103	V.103C0_	10	115	25,90 €	29,79 €	92	20,32 €	23,37 €	22	7,00 €	8,05 €

Láminas ColorSystem 12 cm MADERA / Bars ColorSystem 12 cm WOOD / Séparation ColorSystem 12 cm BOIS

COLOR	REF	U	cm	€	1	cm	€	1	cm	€	1
011	V.011C0_	10	115	34,04 €	39,15 €	92	26,58 €	30,57 €	22	8,74 €	10,05 €
014	V.014C0_	10	115	34,04 €	39,15 €	92	26,58 €	30,57 €	22	8,74 €	10,05 €
015	V.015C0_	10	115	34,04 €	39,15 €	92	26,58 €	30,57 €	22	8,74 €	10,05 €
100	V.100C0_	10	115	34,04 €	39,15 €	92	26,58 €	30,57 €	22	8,74 €	10,05 €
101	V.101C0_	10	115	34,04 €	39,15 €	92	26,58 €	30,57 €	22	8,74 €	10,05 €

Láminas ColorSystem 12 cm METAL / Bars ColorSystem 12 cm METAL / Séparation ColorSystem 12 cm MÉTAL

COLOR	REF	U	cm	€	1	cm	€	1	cm	€	1
016	V.016C0_	10	115	93,84 €	107,92 €	92	72,60 €	83,49 €	22	21,76 €	25,02 €
017	V.017C0_	10	115	93,84 €	107,92 €	92	72,60 €	83,49 €	22	21,76 €	25,02 €

Los precios están indicados para láminas con una longitud total de 3050mm. /
Prices shown include laminates up to 3050mm. long. /
Les prix sont indiqués pour laminés jusqu'à 3050mm. de longueur.



Wengué / Wenge / Wenge



Cerezo / Cherry / Merisier



Roble blanco / White oak / Chêne blanc

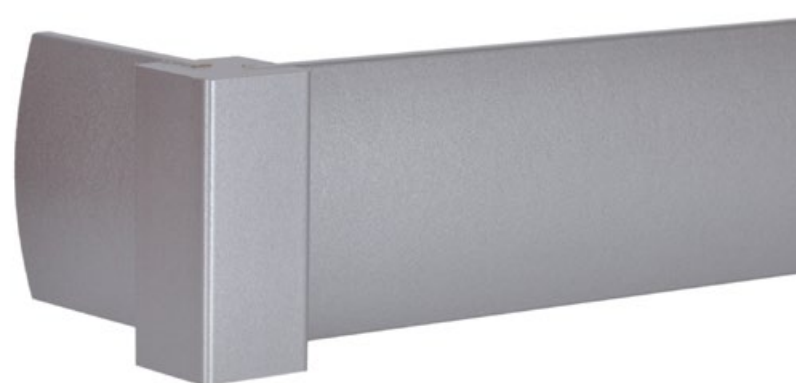

Plata mate / Matt nickel / Nickel satiné



Roble / Oak / Chêne



Gris ceniza / Ash grey / Gris cendre

Perfil Galería Madera 10 cm /
Wood Pelmet Profile 10 cm /
Cantonnière Rail Bois 10 cm

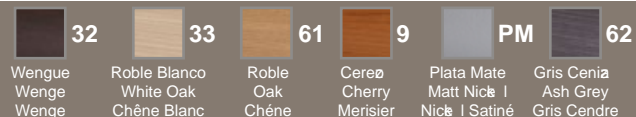

Wengué / Wenge / Wenge



REF				
G.10024432	10	21,22 €	24,40 €	244
G.10036632	10	31,62 €	36,36 €	366

Roble blanco / White Oak / Chêne Blanc



REF				
G.10024433	10	21,22 €	24,40 €	244
G.10036633	10	31,62 €	36,36 €	366

Roble / Oak / Chêne



REF				
G.10024461	10	21,22 €	24,40 €	244
G.10036661	10	31,62 €	36,36 €	366

Cerezo / Cherry / Cerise



REF				
G.1002449	10	21,22 €	24,40 €	244
G.1003669	10	31,62 €	36,36 €	366

Plata mate / Matt Nickel / Nickel Satiné



REF				
G.100244PM	10	28,12 €	32,34 €	244
G.100366PM	10	42,16 €	48,48 €	366

Perfil Galería Madera 10 cm /
Wood Pelmet Profile 10 cm /
Cantonnière Rail Bois 10 cm

	32		33		61		9		PM		62
Wengue Wenge Wenge		Roble Blanco White Oak Chêne Blanc		Roble Oak Chêne		Cerezo Cherry Merisier		Plata Mate Matt Nickel Nickel Satiné		Gris Ceniza Ash Grey Gris Cendre	

Gris Ceniza / Ash Grey / Gris Cendre



REF				
G.10024462	10	21,22 €	24,40 €	244
G.10036662	10	31,62 €	36,36 €	366

Contenido del Kit / Kit components / Composants du Kit

Esta colección NO dispone de un kit como otras colecciones. Se pide por piezas y sólo admite 2 medidas: 244 ó 366cm (sin corte a medida).

This collection is not supplied in kits as others collections. It is ordered per piece and supplied in 2 sizes: 244 and 366 without cuts to measure.

Cette collection n'est pas fournie dans kits comme les cantonnières d'autres collections. Commandés par pièces détachées et fourni en mesures 244 et 366 sans coups.

Accesorios / Accessories / Accessoires

Escuadra
Caja 100 u

Bracket 100 u /
Support 100 u



REF					
D.10U		-	1	0,44 €	
D.10		1	-	43,46 €	

Empalme

Splice /
Raccordeur

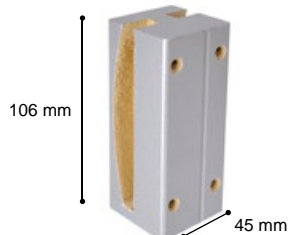

REF					
G.10232		10	21,34 €	24,54 €	
G.10233		10	21,34 €	24,54 €	
G.10261		10	21,34 €	24,54 €	
G.10262		10	21,34 €	24,54 €	
G.1029		10	21,34 €	24,54 €	
G.102PM		10	21,34 €	24,54 €	

Codo rincón

Inner joint /
Coude Intérieur

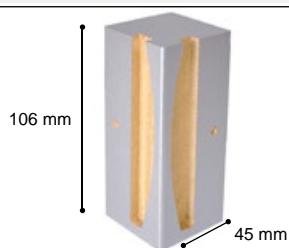

REF					
G.10332		10	17,70 €	20,36 €	
G.10333		10	17,70 €	20,36 €	
G.10361		10	17,70 €	20,36 €	
G.10362		10	17,70 €	20,36 €	
G.1039		10	17,70 €	20,36 €	
G.103PM		10	17,70 €	20,36 €	

Codo esquina

Outer joint /
Coude Extérieur

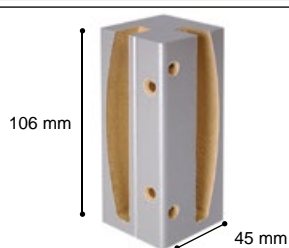

REF					
G.10132		10	17,48 €	20,10 €	
G.10133		10	17,48 €	20,10 €	
G.10161		10	17,48 €	20,10 €	
G.10162		10	17,48 €	20,10 €	
G.1019		10	17,48 €	20,10 €	
G.101PM		10	17,48 €	20,10 €	

Muestra
GALERÍA MADERA

Demo sample
WOOD PELMET /
Echantillon
Cantonnière BOIS



REF					
M.6		1		22,48 €	

Galería 10cm Aluminio / Aluminium Pelmet 10cm / Cantonnière Aluminium 10 cm

Conjuntos completos Galería Aluminio 10 cm /
Aluminium Pelmet Complet sets 10 cm /
Kits complete Cantonnière en Aluminium 10 cm

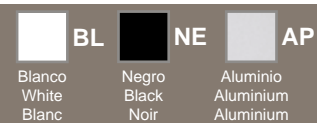

Galería 10 cm



REF	U	€	€	cm
K.30100	1	-	26,24 €	100
K.30150	1	-	33,09 €	150
K.30200	1	-	39,93 €	200
K.30250	1	-	46,77 €	250
K.30300	1	-	53,61 €	300
K.30350	1	-	64,56 €	350
K.30400	1	-	71,40 €	400
K.30500	1	-	85,09 €	500
K.30600	1	-	98,77 €	600

Contenido del Kit / Kit components / Composants du Kit

- Perfil de aluminio y 2 esquinas.
- Aluminium profile & 2 outer joints.
- Rail en aluminium et 2 coudes extérieurs.

Accesorios / Accessories / Accessoires

Perfil de aluminio 10 cm Aluminium Profile / Rail aluminium		<table border="1"> <thead> <tr> <th>REF</th> <th>∅</th> <th>U</th> <th>€</th> <th>€</th> <th>cm</th> </tr> </thead> <tbody> <tr> <td>C.12030AP</td> <td></td> <td>60</td> <td>11,90 €</td> <td>13,69 €</td> <td></td> </tr> <tr> <td>C.12030BL</td> <td></td> <td>60</td> <td>11,90 €</td> <td>13,69 €</td> <td></td> </tr> <tr> <td>C.12030NB</td> <td></td> <td>60</td> <td>11,90 €</td> <td>13,69 €</td> <td></td> </tr> </tbody> </table>	REF	∅	U	€	€	cm	C.12030AP		60	11,90 €	13,69 €		C.12030BL		60	11,90 €	13,69 €		C.12030NB		60	11,90 €	13,69 €	
REF	∅	U	€	€	cm																					
C.12030AP		60	11,90 €	13,69 €																						
C.12030BL		60	11,90 €	13,69 €																						
C.12030NB		60	11,90 €	13,69 €																						
Esquina 10cm Outer joint / Coude extérieur		<table border="1"> <thead> <tr> <th>REF</th> <th>∅</th> <th>U</th> <th>€</th> <th>€</th> <th>cm</th> </tr> </thead> <tbody> <tr> <td>G.12AP</td> <td></td> <td>10</td> <td>5,46 €</td> <td>6,28 €</td> <td></td> </tr> <tr> <td>G.12BL</td> <td></td> <td>10</td> <td>5,46 €</td> <td>6,28 €</td> <td></td> </tr> <tr> <td>G.12NB</td> <td></td> <td>10</td> <td>5,46 €</td> <td>6,28 €</td> <td></td> </tr> </tbody> </table>	REF	∅	U	€	€	cm	G.12AP		10	5,46 €	6,28 €		G.12BL		10	5,46 €	6,28 €		G.12NB		10	5,46 €	6,28 €	
REF	∅	U	€	€	cm																					
G.12AP		10	5,46 €	6,28 €																						
G.12BL		10	5,46 €	6,28 €																						
G.12NB		10	5,46 €	6,28 €																						
Rincón 10cm Inner joint / Coude intérieur		<table border="1"> <thead> <tr> <th>REF</th> <th>∅</th> <th>U</th> <th>€</th> <th>€</th> <th>cm</th> </tr> </thead> <tbody> <tr> <td>G.13AP</td> <td></td> <td>10</td> <td>5,46 €</td> <td>6,28 €</td> <td></td> </tr> <tr> <td>G.13BL</td> <td></td> <td>10</td> <td>5,46 €</td> <td>6,28 €</td> <td></td> </tr> <tr> <td>G.13NB</td> <td></td> <td>10</td> <td>5,46 €</td> <td>6,28 €</td> <td></td> </tr> </tbody> </table>	REF	∅	U	€	€	cm	G.13AP		10	5,46 €	6,28 €		G.13BL		10	5,46 €	6,28 €		G.13NB		10	5,46 €	6,28 €	
REF	∅	U	€	€	cm																					
G.13AP		10	5,46 €	6,28 €																						
G.13BL		10	5,46 €	6,28 €																						
G.13NB		10	5,46 €	6,28 €																						
Muestra GALERÍA 10 CM Demo sample 10 cm PELMET / Echantillon Cantonnière 10 cm		<table border="1"> <thead> <tr> <th>REF</th> <th>∅</th> <th>U</th> <th>€</th> <th>€</th> <th>cm</th> </tr> </thead> <tbody> <tr> <td>M.5</td> <td></td> <td>1</td> <td></td> <td>11,24 €</td> <td></td> </tr> </tbody> </table>	REF	∅	U	€	€	cm	M.5		1		11,24 €													
REF	∅	U	€	€	cm																					
M.5		1		11,24 €																						

Perfil para BANDÓ / Pelmet rails / Rails pour cantonnières

STAR: Perfil de aluminio velcrado (15x23 mm) / Pelmet rail with bonded velcro / Rail velcro pour cantonnière



REF				
C.12010BL	60 m	3,76 €/m	4,32 €/m	600

* Perfil STAR, con cinta cierre para colocar a techo o pared. / STAR pelmet rail, with bonded Touch&close fastener tape for ceiling or wall fixing. / Cantonnière STAR avec ruban adhesif pour fixation plafond ou murale.

CLASSIC: Perfil de aluminio velcrado (15x23 mm) / Pelmet rail with bonded velcro / Rail velcro pour cantonnière



REF				
C.12011	60 m	5,00 €/m	5,75 €/m	600

Accesorios / Accessories / Accessoires

Soporte de plástico

Plastic bracket / Support plastique



REF					
D.29		50	0,68 €	0,82 €	

Soporte articulado de plástico

Articulated plastic bracket / Support plastique articulé



REF					
D.2		50	1,06	1,27 €	

Empalme

Splice / Raccordeur



REF					
D.300		50	1,16	1,39 €	

Muestra BANDÓ

BANDÓ Demo sample / Echantillon BANDÓ

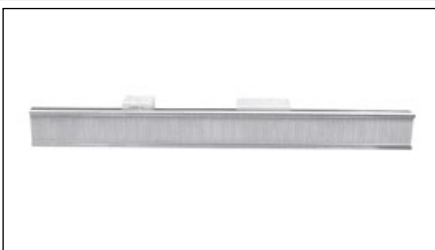

REF					
M.308		1		11,26 €	



ALTRAN[®]

CURTAIN DECORATION SYSTEMS

Rieles Manuales

hand-drawn curtain tracks / rails tirage manuel



CURVAMOS RIELES



disponemos de 5 opciones de rieles curvos







Sistemas profesionales para proyectos decorativos

DECOTRIM Riel Manual / Hand-Drawn Track DECOTRIM / Rail DECOTRIM Tirage Manuel





Información General / General Information / Informations Générales

-  Riel de Aluminio lacado de accionamiento manual para cortinas de peso medio (4 kg/m). Colores: Blanco, Plata y Acero. Riel Versátil, resistente y adaptable. Una elección acertada para casi todo tipo de instalaciones.
-  Aluminium curtain track, hand-drawn, for medium weight curtains (4 kg/m). Colors: White, Anodized Silver & Steel. Durable and adaptable track of versatile use. The right choice for almost all type of installations.
-  Rail en aluminium de manoeuvre manuelle pour rideau de poids moyen (4 kg/m). Couleurs: Blanc, Argent Anodisé et Acier. Rail solide et adaptable d'utilisation versatile. Le bon choix pour presque toute sorte d'installation.



BLANCO / WHITE / BLANC	REF	Soportes Brackets Supports	Correderas Gliders Glisseur				
	E.1004	2	10	10	11,98 €	13,78 €	100
	E.1504	3	16	10	14,96 €	17,95 €	150
	E.2004	3	20	10	18,32 €	21,98 €	200
	E.2504	4	26	10	22,30 €	26,76 €	250
	E.3004	4	30	10	25,68 €	30,82 €	300
Incremento para Sistema Onda Perfecta Price increase perfect wave system Hausse prix système onde parfaite	E.3504	5	36	10	29,66 €	35,59 €	350
D.111: 4,80 €/m	E.4004	5	40	10	33,02 €	39,62 €	400
D.112: 3,30 €/m	E.4504	5	46	10	36,00 €	43,20 €	450
D.113: 3,30 €/m	E.5004	6	50	10	40,36 €	48,43 €	500
D.114: 3,30 €/m	E.5504	6	56	10	43,84 €	52,61 €	550
	E.6004	6	60	10	46,18 €	55,42 €	600



ACERO / STEEL / ACIER	REF	Soportes Brackets Supports	Correderas Gliders Glisseur				
	E.1004A	2	10	10	15,48 €	17,80 €	100
	E.1504A	3	16	10	20,22 €	24,26 €	150
	E.2004A	3	20	10	25,32 €	30,38 €	200
	E.2504A	4	26	10	31,06 €	37,27 €	250
	E.3004A	4	30	10	36,18 €	43,42 €	300
Incremento para Sistema Onda Perfecta Price increase perfect wave system Hausse prix système onde parfaite	E.3504A	5	36	10	41,92 €	50,30 €	350
D.111: 4,80 €/m	E.4004A	5	40	10	47,02 €	56,42 €	400
D.112: 3,30 €/m	E.4504A	5	46	10	51,76 €	62,11 €	450
D.113: 3,30 €/m	E.5004A	6	50	10	57,88 €	69,46 €	500
D.114: 3,30 €/m	E.5504A	6	56	10	63,10 €	75,72 €	550
	E.6004A	6	60	10	67,18 €	80,62 €	600

DECOTRIM Riel Manual / Hand-Drawn Track DECOTRIM / Rail DECOTRIM Tirage Manuel



Anodizado Plata
Anodisé d'Argent
Argent Anodisé

PLATA / SILVER / ARGENT

Conjuntos completos con soporte a techo (D.44)
Complete sets with ceiling Bracket (D.44)
Kits complets avec support Plafond (D.44)

Incremento para Sistema Onda Perfecta
Price increase perfect wave system
Hausse prix système onde parfaite

D.111: 4,80 €/m
D.112: 3,30 €/m
D.113: 3,30 €/m
D.114: 3,30 €/m

REF	Soportes Brackets Supports	Correderas Gliders Glisseur	U	€	€	cm
E.1004AP	2	10	10	12,60 €	14,49 €	100
E.1504AP	3	16	10	15,90 €	19,08 €	150
E.2004AP	3	20	10	19,56 €	23,47 €	200
E.2504AP	4	26	10	23,84 €	28,61 €	250
E.3004AP	4	30	10	27,54 €	33,05 €	300
E.3504AP	5	36	10	31,82 €	38,18 €	350
E.4004AP	5	40	10	35,48 €	42,58 €	400
E.4504AP	5	46	10	38,78 €	46,54 €	450
E.5004AP	6	50	10	43,26 €	51,91 €	500
E.5504AP	6	56	10	47,24 €	56,69 €	550
E.6004AP	6	60	10	49,88 €	59,86 €	600

Indicar siempre el Modo de Apertura al efectuar el pedido cuando se solicite el Riel DecoTrim montado con Onda Perfecta.

Please indicate opening mode in the case of Decotrim with perfect wave.

Merci d'indiquer le mode d'ouverture dans le cas du Decotrim avec onde parfaite wave.

Componentes / Components / Composants

Riel
Track /
Rail

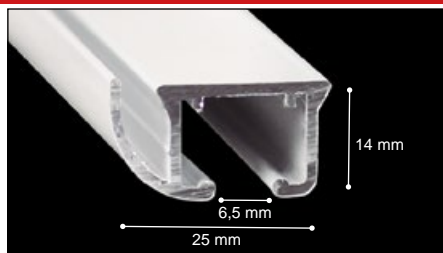

REF	∅	U	€	€	cm
C.12043BL		60 m	4,80 €/m	5,52 €/m	600
C.12043A		60 m	8,80 €/m	10,12 €/m	600
C.12043AP		60 m	5,40 €/m	6,21 €/m	600

NEW

*Tapa
*Endcap /
*Bouchon final



REF	∅	U	€	€	cm
D.011		25	0,98 €	1,13 €	
D.011GR		25	0,98 €	1,13 €	

NEW

* Tapa con alojamiento para corredera tope
Endcap with hosting for endstop runner / Bouchon final pour glisseur d'arrêt.

Soporte techo
Ceiling Bracket /
Support Plafond



REF	∅	U	€	€	cm
D.44		50	1,04 €	1,20 €	

* Soporte incluido en el kit / Bracket supplied in the kit / Support fourni dans le kit.

Componentes / Components / Composants

Corredera

Plastic Runner /
Coulisse Plastic

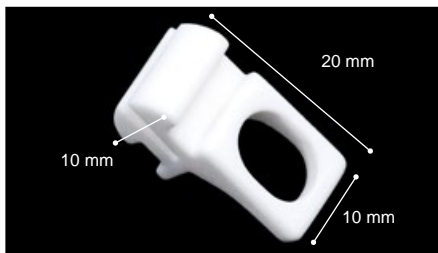

REF	Ø	U	€	€	cm
D.07		500	0,064 €	0,077 €	

Corredera Tope

End-Stop Runner /
Glisseur d'arrêt



REF	Ø	U	€	€	cm
D.016		100	0,58 €	0,70 €	

NEW

Corredera Maestra

Plastic Master
Runner /
Coulisse Plastic
Principal

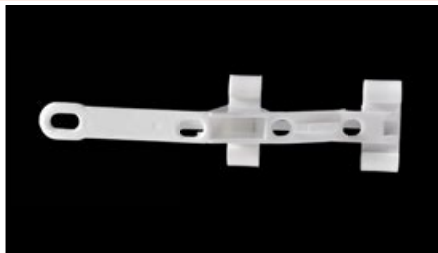

REF	Ø	U	€	€	cm
D.42		25	3,22 €	3,70 €	

Rollo Cinta
Acordeón con
Automáticos

Ruffle-tape roll
with snap-buttons /
Rouleau ruban
accordéon avec
système automat



REF	Ø	U	€	€	cm
D.111		1	203,28 €	233,77 €	100

* 1 rollo contiene 840 corchetes / Roll of 840 Snaps / Rouleau de 840 crochets.

Rollo Corredera
Acordeón

Corded
gliders roll /
Rouleau glisseurs
acordeón

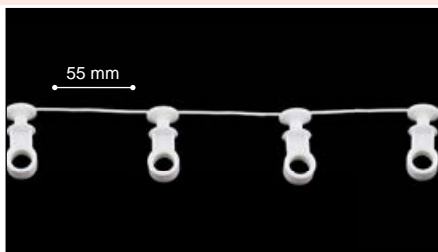

REF	Ø	U	€	€	cm
D.112		1	151,20 €	173,88 €	

* 1 rollo contiene 1000 correderas / Roll of 1000 runners / Rouleau de 1000 glisseurs.

Rollo Corredera
Onda Perfecta

Perfect wave
runners roll /
Rouleau de
glisseur
"onde parfaite"

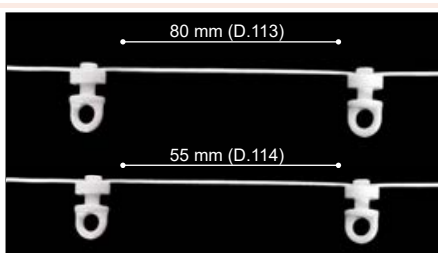

REF	Ø	U	€	€	cm
D.113		1	151,20 €	173,88 €	8
D.114		1	151,20 €	173,88 €	5,5

* 1 rollo contiene 1000 correderas / Roll of 1000 runners / Rouleau de 1000 glisseurs.

Empalme
Trim y Decotrim

Trim & Decotrim
splice /
Raccordeur
Trim et Decotrim



REF	Ø	U	€	€	cm
D.017		50	1,90 €	2,19 €	

NEW

Tornillo Tope

End-stop Screw /
Vis d'arrêt



REF	Ø	U	€	€	cm
D.08		1000	0,31 €/ud	0,37 €/ud	

Componentes / Components / Composants

Soporte techo
Abierto Iniv sible

Iniv sible Open
Ceiling Bracket /
Support Plafond
Ouvert Iniv sible

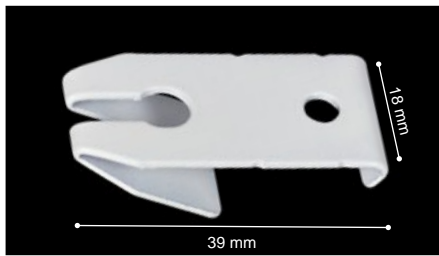

REF	Ø	U	€	€	cm
D.014		50	0,54 €	0,65 €	

NEW

Soporte techo
Cerrado Iniv sible

Iniv sible Closed
Ceiling Bracket /
Support Plafond
Fermé Iniv sible

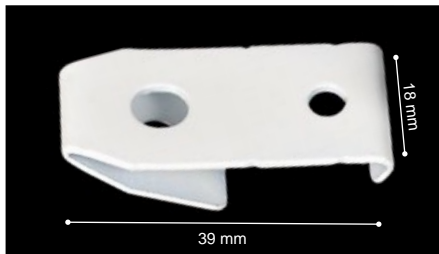

REF	Ø	U	€	€	cm
D.015		50	0,54 €	0,65 €	

NEW

Soporte Techo

Ceiling Bracket /
Support Plafond



REF	Ø	U	€	€	cm
D.01		50	0,86 €	0,99 €	

Soporte Techo

Ceiling Bracket /
Support Plafond



REF	Ø	U	€	€	cm
D.04		50	0,36 €	0,43 €	

Soporte Doble
Pared

Double Wall
Bracket /
Support Mur double



REF	Ø	U	€	€	cm
D.03		25	6,40 €	7,36 €	

Soporte Pared
Wall Bracket /
Support Mur

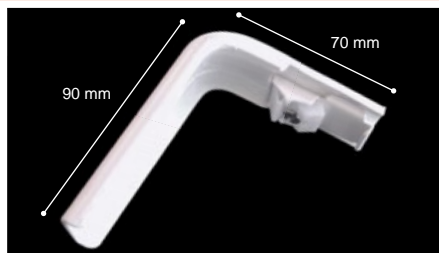

REF	Ø	U	€	€	cm
D.02		25	4,42 €	5,08 €	

Soporte múltiple
de pared Blanco

White Wall
Extension Bracket /
Support Blanc
Mural



REF	Ø	U	€	€	cm
D.301BL		25	1,98 €	2,38 €	4
D.302BL		25	2,08 €	2,50 €	6
D.303BL		25	2,36 €	2,83 €	10
D.304BL		25	3,00 €	3,60 €	15
D.305BL		25	4,78 €	5,74 €	20

Muestra riel
DECOTRIM

Demo sample
DECOTRIM track /
Echantillon
Rail DECOTRIM

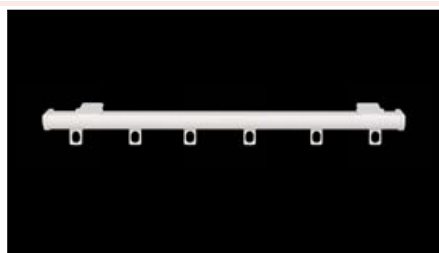

REF	Ø	U	€	€	cm
M.314		1		11,54 €	

TRIM Riel Manual / Hand-Drawn Track TRIM / Rail TRIM Tirage Manuel

TRIM	REF	Soportes Brackets Supports	Correderas Gliders Glisseur				
	Conjuntos completos con soporte a techo (D.44)	E.1002	2	10	10	8,20 €	9,84 €
Complete sets with ceiling Bracket (D.44) /	E.1502	3	16	10	11,80 €	14,16 €	150
Kits complets avec support Plafond (D.44)	E.2002	3	20	10	14,84 €	17,81 €	200
	E.2502	4	26	10	18,46 €	22,15 €	250
	E.3002	4	30	10	21,50 €	25,80 €	300
	E.3502	5	36	10	25,10 €	30,12 €	350
Incremento para Sistema Onda Perfecta	E.4002	5	40	10	28,16 €	33,79 €	400
Price increase perfect wave system	E.4502	5	46	10	31,48 €	37,78 €	450
Hausse prix système onde parfaite	E.5002	6	50	10	34,78 €	41,74 €	500
D.111: 4,80 €/m	E.5502	6	56	10	38,12 €	45,74 €	550
D.112: 3,30 €/m	E.6002	6	60	10	41,16 €	49,39 €	600
D.113: 3,30 €/m							
D.114: 3,30 €/m							

Información General / General Information / Informations Générales

- Riel de Aluminio Blanco de accionamiento manual para cortinas de peso medio (4 kg/m).
Riel Versátil, resistente y adaptable. Una elección acertada para casi todo tipo de instalaciones.
SE PUEDE CURVAR y ARQUEAR. El cliente debe aportar plantilla.
El Curvado del Riel Trim permite diferentes Ángulos (con un radio de 10 cm).
 - Coste por curvar en Ángulo: 70% del Precio de Tarifa del Riel (con un precio mínimo de 14,70 €PVP).
 - Coste por curvar en Arco continuo: 35,72 €PVP.
- White aluminium curtain track, hand-drawn, for medium weight curtains (4 kg/m).
Durable and adaptable track of versatile use. The right choice for almost all type of installations.
Bend of TRIM track The client should provide the template.
It can be curved to customer specifications at different angles and shapes (with a minimum radius of 10 cm).
 - Cost for curving at angle: 70% of the kit tariff price (minimum fee of € 14,70 SRP).
 - Cost for curving in continuous arching: 35,72 €prix SRP.
- Rail en aluminium Blanc de manoeuvre manuelle pour rideau de poids moyen (4kg/m).
Sólido, adaptable rail d'utilisation versatile. Le bon choix pour presque toute sorte d'installation.
Cintrage du rail TRIM. Le client doit fournir le modèle.
On peut produire différentes formes et cintrage dans divers angles (avec un radius minimum de 10 cm).
 - Coût par cintrer en angle: 70% du prix tarif du kit (à un prix minimum de 14,70 € prix PVP).
 - Coût par cintrer en arc continu: 35,72 € prix PVP.

Componentes / Components / Composants

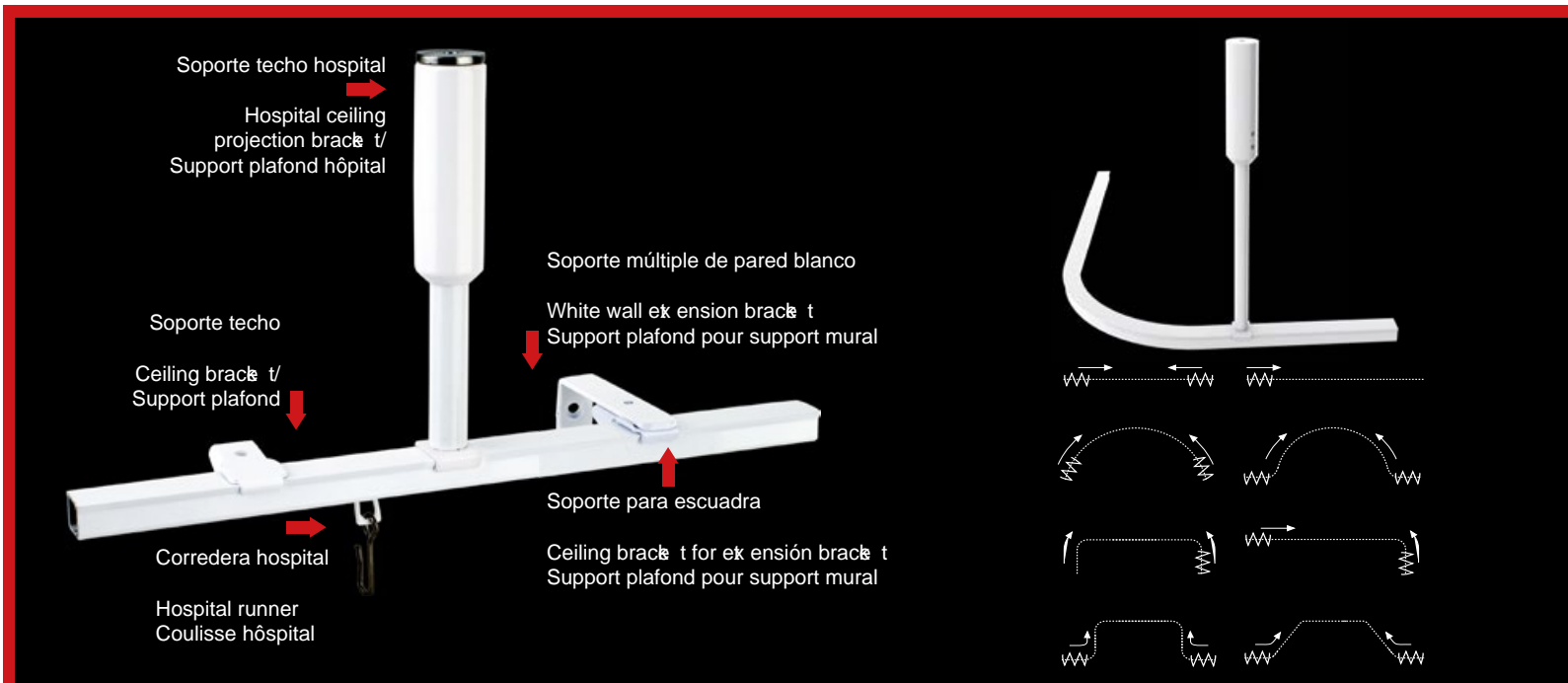

Componentes / Components / Composants

Riel
Track / Rail



REF	∅	U	€	€	cm
C.12042BL		60m	4,04 €/m	4,65 €/m	600

*Tapa
*Encap /
*Bouchon final

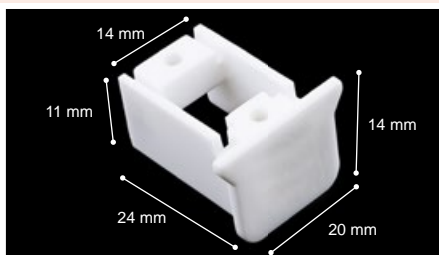

REF	∅	U	€	€	cm
D.06		25	0,35 €	0,42 €	

* Tapa con alojamiento para corredera tope
Encap w/hosting for endstop runner / Bouchon final pour glisseur d'arrêt.

Cantonera con ruedas

End Pulley
with wheels /
Bouchons Finaux
a roue



REF	∅	U	€	€	cm
D.013		50	3,82 €	4,39 €	

Máquina sencilla
curvar TRIM
ángulo 90°

Bending Machine
TRIM (curves 90°) /
Machine pour
Cintrer TRIM
(Cintrage 90°)



REF	∅	U	€	€	cm
M.125		1		657,66 €	

Alma 1m para
curvar

Bending Strip /
Profil de Cintrage



REF	∅	U	€	€	cm
M.126		1		25,20 €	100

Componentes / Components / Composants

Soporte techo
Ceiling Bracket /
Support Plafond



REF	Ø	U	€	1	cm
D.44		50	1,04 €	1,20 €	

* Soporte incluido en el kit / Bracket supplied in the kit / Support fourni dans le kit.

Soporte techo
Abierto
Open Ceiling
Bracket /
Support Plafond
Ouvert

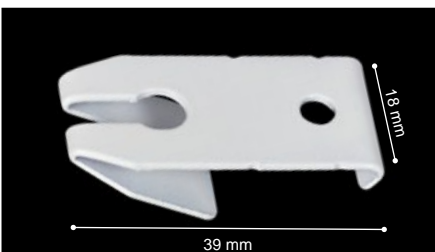

REF	Ø	U	€	1	cm
D.014		50	0,54 €	0,65 €	

NEW

Soporte techo
Cerrado
Closed Ceiling
Bracket /
Support Plafond
Fermé

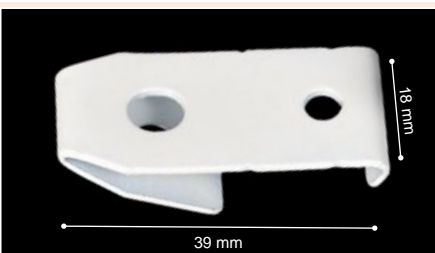

REF	Ø	U	€	1	cm
D.015		50	0,54 €	0,65 €	

NEW

Soporte Pared
Wall Bracket /
Support Mur

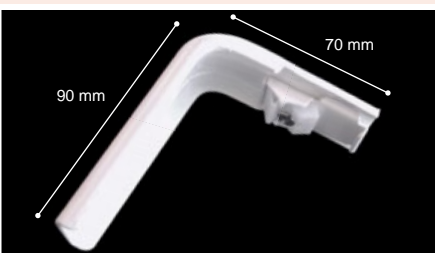

REF	Ø	U	€	1	cm
D.02		25	4,42 €	5,02 €	

Soporte Doble
Pared
Double Wall
Bracket /
Support Mur double



REF	Ø	U	€	1	cm
D.03		25	6,40 €	7,36 €	

Soporte Techo
Ceiling Bracket /
Support Plafond



REF	Ø	U	€	1	cm
D.04		50	0,36 €	0,43 €	

Soporte Techo
Ceiling Bracket /
Support Plafond



REF	Ø	U	€	1	cm
D.01		50	0,86 €	0,99 €	

Soporte Techo
Hospital

Hospital Ceiling
Projection Bracket /
Support
Plafond Hôpital



REF	Ø	U	€	1	cm
D.408		1		24,26 €/m	100
D.409		1		29,10 €/m	150

Componentes / Components / Composants

Corredera Hospital

Hospital Runner /
Coulisse Hôpital



REF	∅	U	€	€	cm
D.010		50	0,52 €	0,62 €	

Tornillo Tope

End-stop /
Vis d'arrêt



REF	∅	U	€	€	cm
D.08		1000	0,31 €/ud	0,37 €/ud	

Corredera

Plastic Runner /
Coulisse Plastic



REF	∅	U	€	€	cm
D.07		500	0,064 €	0,077 €	

Corredera Tope

End-Stop Runner /
Glisseur d'arrêt



REF	∅	U	€	€	cm
D.016		100	0,58 €	0,70 €	

Rollo Cinta Acordeón con Automáticos

Ruffle-tape roll with snap-buttons /
Rouleau ruban accordéon avec boutons automatiques



REF	∅	U	€	€	cm
D.111		1	203,38 €	233,77 €	

* 1 rollo contiene 840 corchetes / Roll of 840 Snaps / Rouleau de 840 crochets.

Rollo Corredera Acordeón

Corded gliders roll /
Rouleau glisseurs acordeón

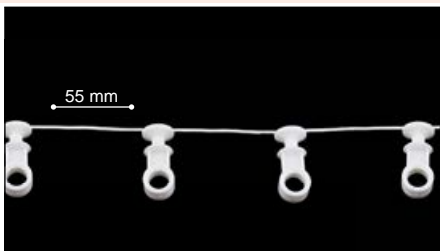

REF	∅	U	€	€	cm
D.112		1	151,20 €	173,88 €	

* 1 rollo contiene 1000 correderas / Roll of 1000 runners / Rouleau de 1000 glisseurs.

Rollo Corredera Onda Perfecta

Perfect wave runners roll /
Rouleau de glisseur "onde parfaite"

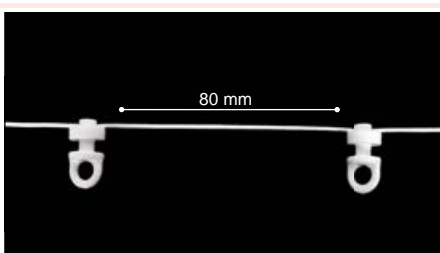

REF	∅	U	€	€	cm
D.113		1	151,20 €	173,88 €	

* 1 rollo contiene 1000 correderas / Roll of 1000 runners / Rouleau de 1000 glisseurs.

Rollo Corredera Onda Perfecta

Perfect wave runners roll /
Rouleau de glisseur "onde parfaite"

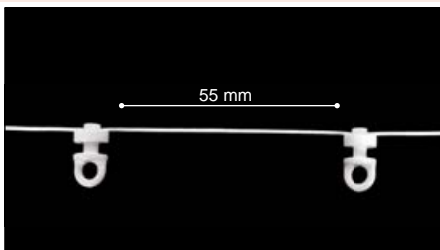

REF	∅	U	€	€	cm
D.114		1	151,20 €	173,88 €	

* 1 rollo contiene 1000 correderas / Roll of 1000 runners / Rouleau de 1000 glisseurs.

Componentes / Components / Composants

Empalme
Trim y Decotrim

Trim & Decotrim
splice /
Raccordeur
Trim et Decotrim



REF	∅	U	€	€ ¹	cm	NEW
D.017		50	1,90 €	2,19 €		

Corredera Maestra

Plastic Master
Runner /
Coulisse Plastic
Principal

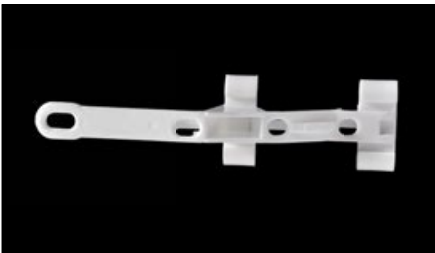

REF	∅	U	€	€ ¹	cm
D.42		25	3,22 €	3,70 €	

Codo Riel

Elbow /
Coude



REF	∅	U	€	€ ¹	cm
D.46		25	1,98 €	2,28 €	

Muestra riel
TRIM

Demo sample
TRIM track /
Echantillon
Rail TRIM

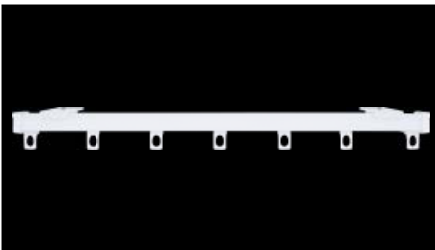

REF	∅	U	€	€ ¹	cm
M.300		1		6,74 €	

ARGENT Riel Manual / Hand-Drawn Track ARGENT / Rail Manuelle ARGENT

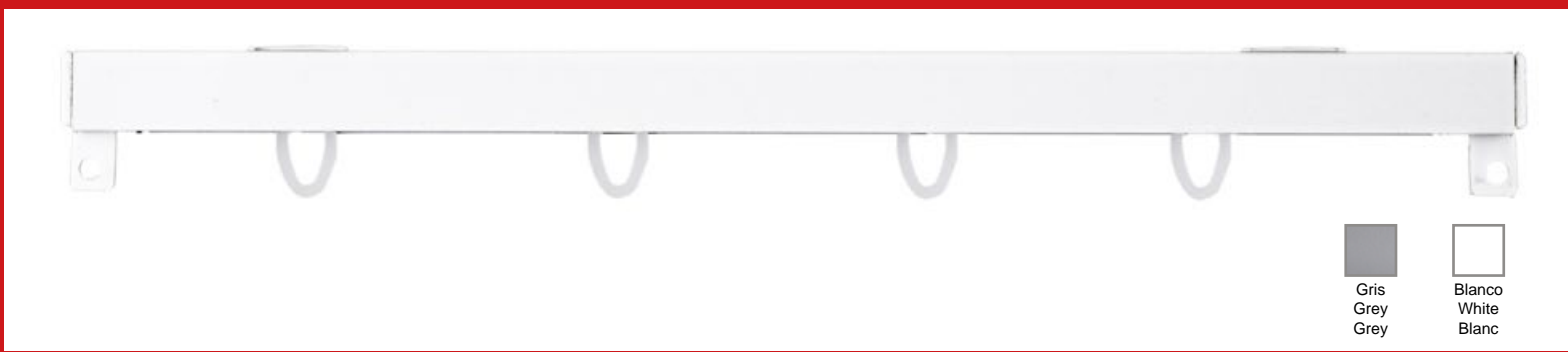

Gris Grey Grey
 Blanco White Blanc

ARGENT	REF	Soportes Brackets Supports	Correderas Gliders Glisseur	U	€	€	cm
	E.1001	2	10	10	7,98 €	9,58 €	100
	E.1501	3	16	10	11,40 €	13,68 €	150
	E.2001	3	20	10	14,42 €	17,30 €	200
	E.2501	4	26	10	17,96 €	21,55 €	250
	E.3001	4	30	10	20,96 €	25,15 €	300
	E.3501	5	36	10	24,42 €	29,30 €	350
	E.4001	5	40	10	27,44 €	32,93 €	400
	E.4501	5	46	10	30,68 €	36,82 €	450
	E.5001	6	50	10	33,98 €	40,78 €	500
	E.5501	6	56	10	37,20 €	44,64 €	550
	E.6001	6	60	10	40,20 €	48,24 €	600

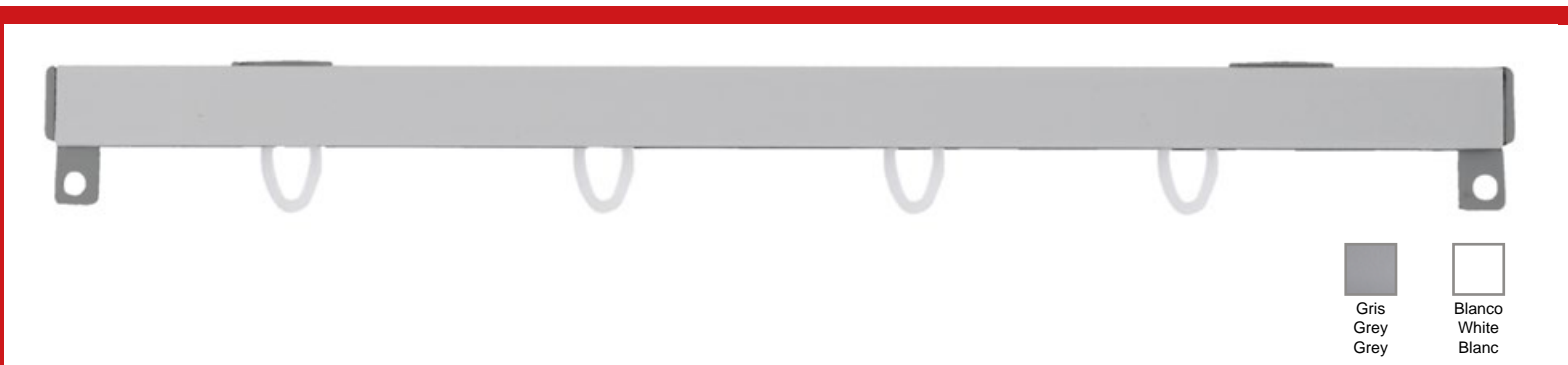

Gris Grey Grey
 Blanco White Blanc

ARGENT GRIS Riel Manual / Hand-Drawn Track GREY ARGENT / Rail Manuelle GREY ARGENT	REF	Soportes Brackets Supports	Correderas Gliders Glisseur	U	€	€	cm
	E.1001AP	2	10	10	8,08 €	9,70 €	100
	E.1501AP	3	16	10	11,70 €	14,04 €	150
	E.2001AP	3	20	10	14,80 €	17,76 €	200
	E.2501AP	4	26	10	18,42 €	22,10 €	250
	E.3001AP	4	30	10	21,52 €	25,82 €	300
	E.3501AP	5	36	10	25,12 €	30,14 €	350
	E.4001AP	5	40	10	28,24 €	33,89 €	400
	E.4501AP	5	46	10	31,54 €	37,85 €	450
	E.5001AP	6	50	10	34,92 €	41,90 €	500
	E.5501AP	6	56	10	38,20 €	45,84 €	550
	E.6001AP	6	60	10	41,34 €	49,61 €	600

Información General / General Information / Informations Générales

- El Riel Argent se puede Curvar en diferentes Ángulos (con un radio de 10 cm. El cliente debe aportar plantilla). Coste por curvar en Ángulo: 70% del Precio de Tarifa del Riel (con un precio mínimo de 14,70 € PVP).
- It can be curved to customer specifications at different angles and shapes (Minimum radius 10cm). The client should provide the template Cost for curving at angle: 70% of the kit tariff price (minimum fee of € 14,70 SRP).
- On peut produire différentes formes et cintrage dans divers angles (radius minimum 10cm). Le client doit fournir le modèle. Coût pour cintrer en angle: 70% du prix tarif du kit (minimum de 14,70 € prix PVP).

Incremento para Sistema Onda Perfecta
 Price increase perfect wave system
 Hausse prix système onde parfaite

D.113: 3,30 €/m
 D.114: 3,30 €/m

Componentes / Components / Composants

Riel de aluminio
(14x17mm.)

Aluminium track
(14x17mm) /
Rail aluminium
(14x17mm)



REF	∅	U	€	€	cm
C.12016BL		60 m	4,18 €/m	4,81 €/m	600
C.12016AP		60 m	4,44 €/m	5,11 €/m	600

Soporte
de plástico

Plastic bracket /
Support plastique

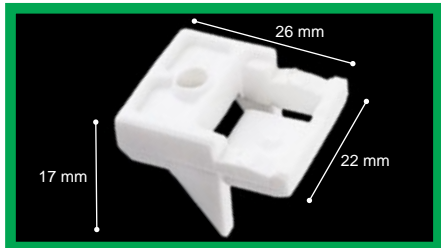

REF	∅	U	€	€	cm
D.25		50	0,392 €	0,470 €	
D.25GR		50	0,392 €	0,470 €	

* Soporte incluido en el kit /
Bracket supplied in the kit / Support fourni dans le kit.

Tapa con agujero
para gancho

End Cap /
Bouchon

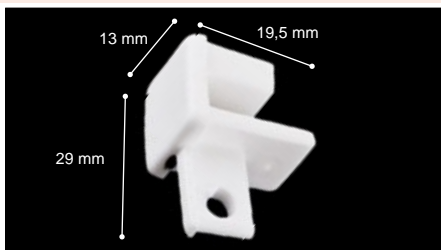

REF	∅	U	€	€	cm
D.22		50	0,37 €	0,44 €	
D.22GR		50	0,37 €	0,44 €	

Corredera con
ruedas

Wheeled glider /
Glisseur a roue



REF	∅	U	€	€	cm
D.23		1000	0,082 €	0,098 €	

Conjunto corredera
maestra

Overlap master
carrier /
Porteur principal
chevauchant



REF	∅	U	€	€	cm
D.1001		50	2,48 €	2,98 €	

Tirador

Wand /
Lance rideau



REF	∅	U	€	€	cm
L.11		25	2,08 €	2,39 €	100
L.11150		25	3,22 €	3,70 €	150

Máquina Curvar
Argent 90°

Argent Bending
Machine 90° /
Machine pour
cintrer 90° Argent



REF	∅	U	€	€	cm
M.122		1		657,66 €	

* Alma para Curvar (Ref. M.120 precio 25,22 € PVP)
Bending strip (Ref. M.120 price 25,22 SRP) / Profil de cintrage (Ref. M.120 prix 25,22 PVP)

Muestra riel
ARGENT

Demo sample
ARGENT track /
Echantillon
Rail ARGENT

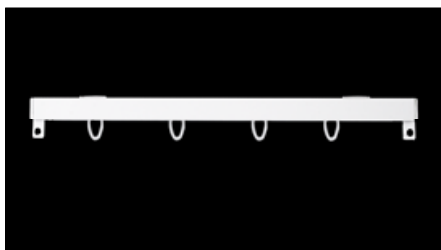

REF	∅	U	€	€	cm
M.301		1		6,74 €	

BALEAR Riel Manual / Hand-Drawn Track BALEAR / Rail Manuelle BALEAR



Blanco
White
Blanc

BALEAR

Conjuntos completos con soporte a techo (D.28) /

Complete sets with ceiling Bracket (D.28) /

Kits complets avec support Plafond (D.28)

Incremento para Sistema Onda Perfecta
Price increase perfect wave system
Hausse prix système onde parfaite
D.113: 3,30 €/m
D.114: 3,30 €/m

REF	Soportes Brackets Supports	Correderas Gliders Glisseur	U	€	€	cm
E.10011	2	10	10	8,54 €	10,25 €	100
E.15011	3	16	10	12,28 €	14,74 €	150
E.20011	3	20	10	14,98 €	17,98 €	200
E.25011	4	26	10	18,70 €	22,44 €	250
E.30011	4	30	10	21,42 €	25,70 €	300
E.35011	5	36	10	25,12 €	30,14 €	350
E.40011	5	40	10	27,84 €	33,41 €	400
E.45011	5	46	10	30,74 €	36,89 €	450
E.50011	6	50	10	34,28 €	41,14 €	500
E.55011	6	56	10	37,16 €	44,59 €	550
E.60011	6	60	10	39,88 €	47,86 €	600

Componentes / Components / Composants

Riel de aluminio
(14x13mm.)

Aluminium track
(14x13mm) /
Rail aluminium
(14x13mm)

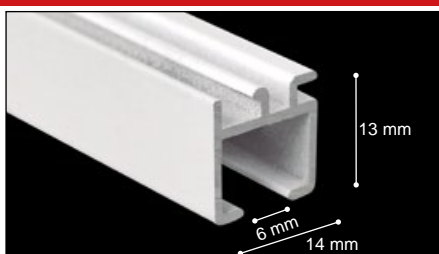

REF	Ø	U	€	€	cm
C.12019BL		60 m	3,62 €/m	4,16 €/m	600

Soporte de techo
àncorado

Metal bracket /
Support metal

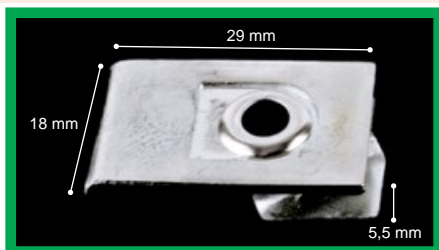

REF	Ø	U	€	€	cm
D.28		50	0,58 €	0,70 €	

* Soporte incluido en el kit /
Bracket supplied in the kit / Support fourni dans le kit.

Tapa con agujero
para gancho

End Cap /
Bouchon



REF	Ø	U	€	€	cm
D.11		50	0,35 €	0,42 €	

Componentes / Components / Composants

Corredera con ruedas

Wheeled glider / Glisseur a roue

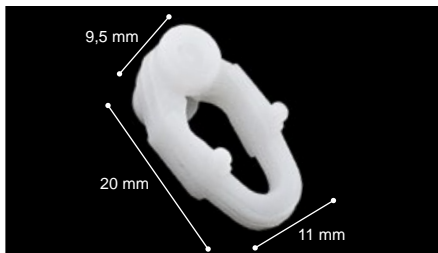

REF	∅	U	€	1	cm
D.23		1000	0,082 €	0,098 €	

Corredera

Glider / Glisseur

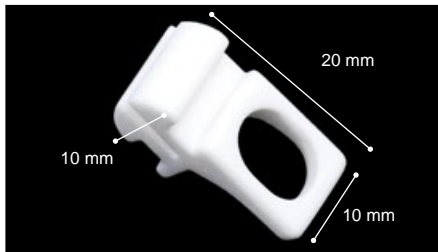

REF	∅	U	€	1	cm
D.07		500	0,064 €	0,077 €	

Rollo Corredera Onda Perfecta

Perfect wave runners roll / Rouleau de glisseur "onde parfaite"

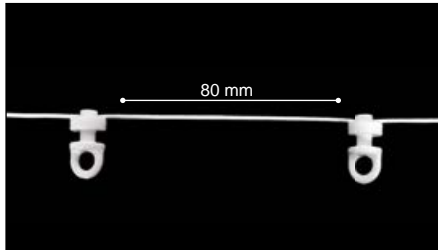

REF	∅	U	€	1	cm
D.113		1	151,20 €	173,88 €	

* 1 rollo contiene 1000 correderas / Roll of 1000 runners / Rouleau de 1000 glisseurs.

Rollo Corredera Onda Perfecta

Perfect wave runners roll / Rouleau de glisseur "onde parfaite"

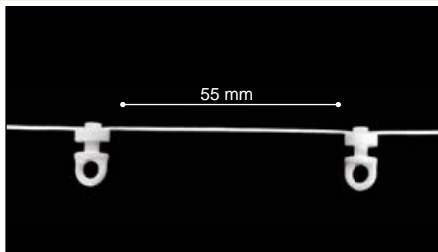

REF	∅	U	€	1	cm
D.114		1	151,20 €	173,88 €	

* 1 rollo contiene 1000 correderas / Roll of 1000 runners / Rouleau de 1000 glisseurs.

Conjunto corredera maestra

Overlap master carrier / Porteur principal chevauchant

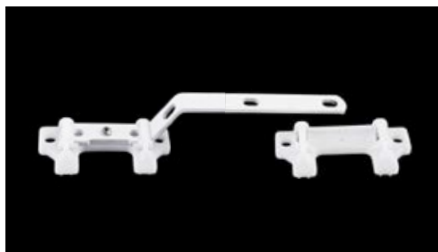

REF	∅	U	€	1	cm
D.1001		50	2,48 €	2,98 €	

Tirador

Wand / Lance rideau



REF	∅	U	€	1	cm
L.11		25	2,08 €	2,39 €	100
L.11150		25	3,22 €	3,70 €	150

Muestra riel BALEAR

Demo sample BALEAR track / Echantillon Rail BALEAR

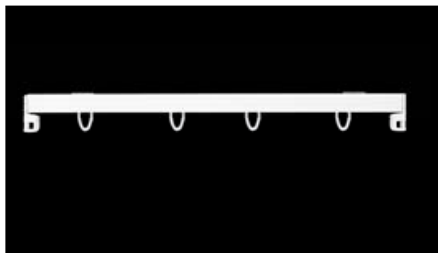

REF	∅	U	€	1	cm
M.302		1		6,74 €	

BASIC Riel Manual / Hand-Drawn Track BASIC / Rail Manuelle BASIC



Blanco
White
Blanc

BASIC

Conjuntos completos. /
Complete sets. /
Kits complets.

Incremento para Sistema Onda Perfecta

Price increase perfect wave syst em
Hausse prix système onde parfaite

D.113: 3,30 €/m

D.114: 3,30 €/m

REF	Soportes Brackets Supports	Correderas Gliders Glisseur	U	€	€	cm
E.1003	-	10	10	7,22 €	8,30 €	100
E.1503	-	16	10	10,20 €	12,24 €	150
E.2003	-	20	10	13,10 €	15,72 €	200
E.2503	-	26	10	16,04 €	19,25 €	250
E.3003	-	30	10	18,92 €	22,70 €	300
E.3503	-	36	10	21,88 €	26,26 €	350
E.4003	-	40	10	24,76 €	29,71 €	400
E.4503	-	46	10	27,72 €	33,26 €	450
E.5003	-	50	10	30,58 €	36,70 €	500
E.6003	-	60	10	36,44 €	43,73 €	600

Componentes / Components / Composants

Riel de aluminio
(25x10mm.)

Aluminium track
(25x10mm) /
Rail aluminium
(25x10mm)

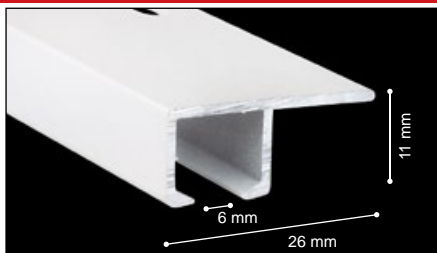

REF	Ø	U	€	€	cm
C.12015BL		60 m	4,30 €/m	4,95 €/m	600

Tapa con agujero
para gancho

End Cap /
Bouchon

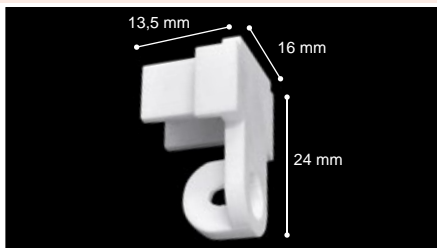

REF	Ø	U	€	€	cm
D.19		100	0,52 €	0,62 €	

Corredera

Glider /
Glisseur

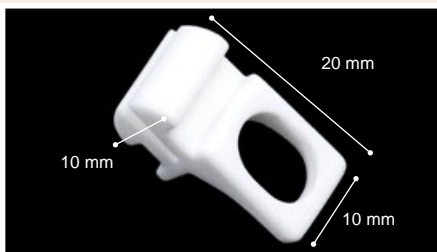

REF	Ø	U	€	€	cm
D.07		500	0,064 €	0,077 €	

Muestra riel
BASIC

Demo sample
BASIC track /
Echantillon
Rail BASIC

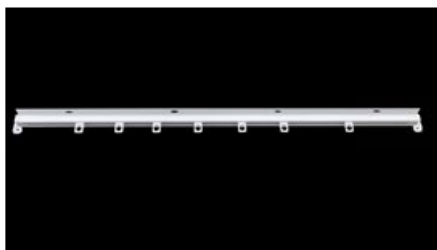

REF	Ø	U	€	€	cm
M.309		1		6,74 €	

FIJO Riel Manual / Hand-Drawn Track FIJO / Rail Manuelle FIJO



Riel FIJO hierro serie 1000 Manual o Cordón /
Hand-drawn or Cord-drawn track /
Rail à tirage Manuel ou à tirage Corde

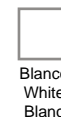

Componentes riel FIJO / FIJO rail Components / Composants FIJO rail

Caña C
(4'8 m)

C-track /
Canne C

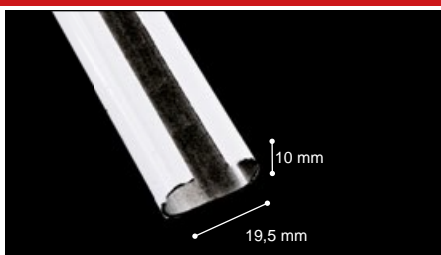

REF	∅	U	€	€	cm
I.1000		48	1,88 €/m	2,16 €/m	480

Caña C perforada
(4 m)

Perforated C-track /
Canne C perforée



REF	∅	U	€	€	cm
I.1000P		100	1,98 €/m	2,28 €/m	400

* Bajo Pedido / Upon Request / Sur Demande

Juego de
cantoneras
(par)

End pulleys (pair) /
Jeux d'angles (paire)



REF	∅	U	€	€	cm
I.1221		20 pares	3,00 €	3,45 €	

Soporte lateral
60mm. (par)

Side bracket
60mm. (pair) /
Support latéral
60mm. (paire)



REF	∅	U	€	€	cm
I.1100		12 pares	1,92 €	2,21 €	

Soporte lateral
80mm. (par)

Side bracket
80mm. (pair) /
Support latéral
80mm. (paire)



REF	∅	U	€	€	cm
I.1101		12 pares	1,92 €	2,21 €	

Soporte lateral
110mm. (par)

Side bracket
110mm. (pair) /
Support latéral
110mm. (paire)



REF	∅	U	€	€	cm
I.1102		12 pares	2,28 €	2,62 €	

Componentes / Components / Composants

Soporte central
60 mm. (par)

Central brace t
60 mm. (pair) /
Support central
60mm. (paire)



REF	∅	U	€	€	cm
I.1200		24	1,28 €	1,47 €	

Soporte central
80 mm. (par)

Central brace t
80 mm. (pair) /
Support central
80mm. (paire)



REF	∅	U	€	€	cm
I.1201		24	1,30 €	1,50 €	

Soporte central
110 mm. (par)

Central brace t
110 mm. (pair) /
Support central
110mm. (paire)



REF	∅	U	€	€	cm
I.1202		24	1,42 €	1,63 €	

Encaje para soporte
lateral (par)

Central brace t
60 mm. (pair) /
Assemblage pour
support latéral
(paire)



REF	∅	U	€	€	cm
I.1105		25 pares	1,26 €	1,45 €	

Estribo soporte

Ceiling brace t /
Support plafond



REF	∅	U	€	€	cm
I.1205		100	0,56 €	0,67 €	

Eκ ensión para
soporte (90mm.)

Brack t ek ension
(90mm) /
Prolongateur pour
support (90mm.)



REF	∅	U	€	€	cm
I.1106		50	1,12 €	1,29 €	

Eκ ensión para
soporte (130mm.)

Brack t ek ension
(130mm) /
Prolongateur pour
support (130mm.)



REF	∅	U	€	€	cm
I.1107		50	1,40 €	1,61 €	

Empalme
para caña

Splice /
Raccord pour
canne



REF	∅	U	€	€	cm
I.1007		20	0,50 €	0,60 €	

Componentes / Components / Composants

Cantenera interior

Inner polley /
Angle intérieur



REF	∅	U	€	€	cm
I.1240		20	0,96 €	1,10 €	

Tornillo con
tuerca M-4

End-Screw M-4 /
Vis d'arrêt M-4

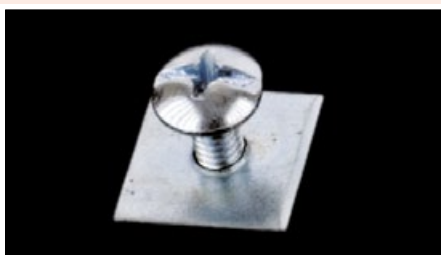

REF	∅	U	€	€	cm
I.1210		200	0,124 €	0,149 €	

Terminal encaje
en soporte

End fitting
bracket /
Support
terminal emboité



REF	∅	U	€	€	cm
I.1402		20	0,48 €	0,58 €	

Corredera
intermedia

Intermediate
runner /
Coulisse
intermédiaire

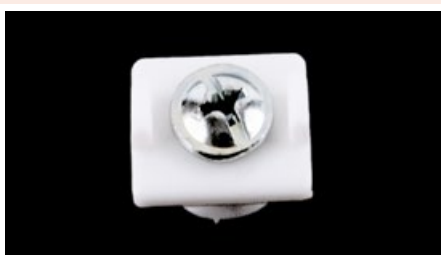

REF	∅	U	€	€	cm
I.1248		20	1,14 €	1,31 €	

Corredera
intermedia encaje
en soporte

Int. runner-bracket
fitting /
Coulisse
intermédiaire
d'assemblage
encastrée



REF	∅	U	€	€	cm
I.1242		20	0,64 €	0,74 €	

Terminal simple

Plain end cap /
Embout



REF	∅	U	€	€	cm
I.1401		100	0,452 €	0,542 €	

Tope terminal con
corredera

Endcap stop
with runner /
Butoir terminal
avec coulisse



REF	∅	U	€	€	cm
I.1400		100	0,62 €	0,71 €	

Corredera plástico

Plastic runner /
Coulisse plástico



REF	∅	U	€	€	cm
I.1307		1000	0,062 €	0,074 €	

Componentes / Components / Composants

Corredera
maestra cura

Curved
master carrier /
Coulisse
maîtresse



REF	∅	U	€	€	cm
I.1300		20	2,84 €	3,27 €	

Juego correderas
maestra simple

Curved master
carrier set /
Jeux de coulisses



REF	∅	U	€	€	cm
I.1301		25	2,08 €	2,39 €	

Corredera
intermedia ancha

Wide
intermediate
runner /
Coulisse
intermédiaire large



REF	∅	U	€	€	cm
I.1302		30	0,78 €	0,90 €	

Corredera maestra
un sentido

Master
carrier-one way /
Coulisse
maîtresse un sens



REF	∅	U	€	€	cm
I.1303		20	1,28 €	1,47 €	

Tope caña
perforada

Track
stop-perforated /
Embout canne
perforée



REF	∅	U	€	€	cm
I.1580		100	0,206 €	0,247 €	

Corredera
horizontal

Horizontal
runner /
Coulisse
horizontale



REF	∅	U	€	€	cm
I.1901		1000	0,124 €	0,149 €	

Rollo 500 metros
cordón de 2,7mm.

Cord roll 2,7mm./
Rouleau de corde
2,7mm.

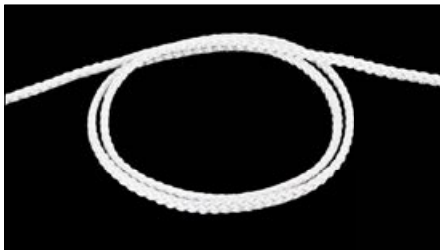

REF	∅	U	€	€	m
D.12P		1	116,40 €		500

Rollo 500 metros
cordón de 3mm.

Cord roll 3mm. /
Rouleau de
corde 3mm.



REF	∅	U	€	€	m
D.12		1	67,60 €		500

Componentes / Components / Composants

Contrapeso petaca

Cordweight /
contrepoids

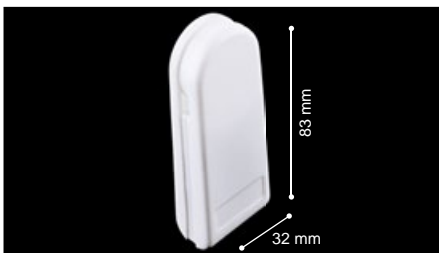

REF	∅	U	€	€	cm
I.1700		25	2,08 €	2,39 €	

Contrapeso mini
(43 g aprox.)

Mini-cordweight /
Mini-contrepoids



REF	∅	U	€	€	cm
I.1110BL		25	1,40 €	1,61 €	
I.1110PL		25	2,12 €	2,44 €	

Tensor sencillo
para cordón

Tensor for cord /
Tenseur pour
cordon



REF	∅	U	€	€	cm
I.8		50	0,42 €	0,50 €	

Tensor perilla

Cord weighted
tassel /
Gland pour corde



REF	∅	U	€	€	cm
I.9		50	1,20 €	1,44 €	

MALEABLE Riel Manual / Hand-Drawn Track MALEABLE / Rail Manuelle MALEABLE



Blanco
White
Blanc

MALEABLE

Conjuntos completos. /
Complete sets. /
Kits completS.

REF	Soportes Brackets Supports	Correderas Gliders Glisseur				
E.71001	2	10	15	7,92 €	9,50 €	100
E.71501	3	16	15	10,92 €	13,10 €	150
E.72001	3	20	15	13,08 €	15,70 €	200
E.72501	4	26	15	16,02 €	19,22 €	250
E.73001	4	30	15	18,18 €	21,82 €	300
E.73501	5	36	15	21,16 €	25,39 €	350
E.74001	5	40	15	23,32 €	27,98 €	400
E.74501	5	46	15	26,32 €	31,58 €	450
E.75001	6	50	15	28,48 €	34,18 €	500
E.76001	7	60	15	33,60 €	40,32 €	600

Información General / General Information / Informations Générales

- Fácil de doblar a la forma deseada con las manos. Ideal para ventanas curvadas o instalaciones con rincones y/o esquinas.
- Easy to bend to the desired shape. Ideal for bay windows or for special installations where corner tracks are required.
- Facile à cintrer. Idéal pour des fenêtres arrondies ou des installations spéciales en coin.



Componentes / Components / Composants

Riel Aluminio
(7x15mm)

Aluminium track
(7x15mm) /
Rail aluminium
(7x15mm)



REF					
C.12020BL		60 m	2,72 €/m	3,13 €/m	600

Soporte de hierro

Steel bracket /
Support acier

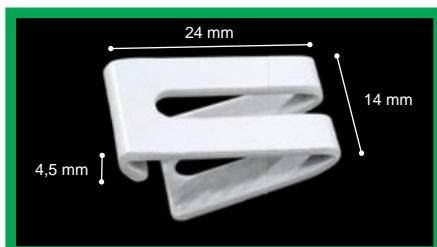

REF					
D.280		50	0,52 €	0,62 €	

* Soporte incluido en el kit / Bracket supplied in the kit / Support fourni dans le kit.

Componentes / Components / Composants

Tapa con agujero para gancho

End Cap / Bouchon



REF	∅	U	€	€	cm
D.110		50	0,74 €	0,85 €	

Corredera

Glider / Glisseur

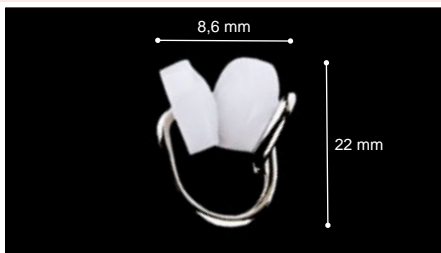

REF	∅	U	€	€	cm
D.420		500	0,144 €	0,173 €	

Tirador

Wand / Lance rideau



REF	∅	U	€	€	cm
L.11		25	2,08 €	2,39 €	100
L.11150		25	3,22 €	3,70 €	150

Muestra riel MALEABLE

Demo sample MALEABLE track / Echantillon Rail MALEABLE



REF	∅	U	€	€	cm
M.304		1		6,74 €	

Riel MÚLTIPLE Manual / Hand-drawn multiple CHANNELS track / Rail aluminium avec tirage Manuel



Blanco
White
Blanc

Riel MÚLTIPLE

2 Carriles de accionamiento Manual /
Hand-drawn **2 Channels** track /
Rail de **2 Voies** avec tirage Manuel

Conjuntos completos
Complete sets/
Kits complets

Incremento para Sistema Onda Perfecta
Price increase perfect wave syst em
Hausse prix système onde parfaite
D.113: 3,30 €/m
D.114: 3,30 €/m

REF	Soportes Brackets Supports	Correderas Gliders Glisseur	U	€	€	cm
E.91002	-	20	1		19,48 €	100
E.91502	-	30	1		27,18 €	150
E.92002	-	40	1		34,26 €	200
E.92502	-	50	1		42,28 €	250
E.93002	-	60	1		49,56 €	300
E.93502	-	70	1		66,88 €	350
E.94002	-	80	1		79,46 €	400
E.94502	-	90	1		86,26 €	450
E.95002	-	100	1		89,68 €	500
E.96002	-	120	1		101,02 €	600



Blanco
White
Blanc

Riel MÚLTIPLE

3 carriles de accionamiento Manual /
Hand-drawn **3 Channels** track /
Rail de **3 Voies** avec tirage Manuel

Conjuntos completos
Complete sets/
Kits complets

Incremento para Sistema Onda Perfecta
Price increase perfect wave syst em
Hausse prix système onde parfaite
D.113: 3,30 €/m
D.114: 3,30 €/m

REF	Soportes Brackets Supports	Correderas Gliders Glisseur	U	€	€	cm
E.91003	-	30	1		29,10 €	100
E.91503	-	48	1		41,44 €	150
E.92003	-	60	1		53,12 €	200
E.92503	-	78	1		66,26 €	250
E.93003	-	90	1		78,20 €	300
E.93503	-	108	1		102,44 €	350
E.94003	-	120	1		116,66 €	400
E.94503	-	130	1		129,98 €	450
E.95003	-	150	1		138,92 €	500
E.96003	-	180	1		153,46 €	600

Riel MÚLTIPLE Manual / Hand-drawn multiple CHANNELS track / Rail aluminium avec tirage Manuel

Blanco
White
Blanc

Riel ASIMÉTRICO

3 carriles asimétricos de accionamiento Manual /
3 asymmetrical channels hand-drawn channels /
3 voies asymétriques de tirage manual
Conjuntos completos
Complete sets/ Kits complets

Incremento para Sistema Onda Perfecta
Price increase perfect wave syst em
Hausse prix syst ème onde parfaite
D.113: 3,30 €/m
D.114: 3,30 €/m

REF	Soportes Brackets Supports	Correderas Gliders Glisseur	U	€	€	cm
E.101003	-	30	1		23,40 €	100
E.101503	-	48	1		33,72 €	150
E.102003	-	60	1		42,74 €	200
E.102503	-	78	1		52,68 €	250
E.103003	-	90	1		62,06 €	300
E.103503	-	108	1		72,00 €	350
E.104003	-	120	1		83,70 €	400
E.104503	-	130	1		91,34 €	450
E.105003	-	150	1		100,72 €	500
E.106003	-	180	1		120,04 €	600



El riel múltiple 4 vías es el único riel múltiple que permite el uso de galería bandó. La galería se suministra aparte. /
The 4-channel rail is the only multiple rail that can be installed with pelmet. The pelmet should be ordered separately. /
Le rail de 4 canaux est le seul rail qui peut être installé avec cantonnière bandeau. La cantonnière est commandé séparément.

Blanco
White
Blanc

Riel MÚLTIPLE

4 carriles de accionamiento Manual /
Hand-drawn 4 Channels track /
Rail de 4 Voies avec tirage Manuel

Conjuntos completos
Complete sets/
Kits complets

Incremento para Sistema Onda Perfecta
Price increase perfect wave syst em
Hausse prix syst ème onde parfaite
D.113: 3,30 €/m
D.114: 3,30 €/m

REF	Soportes Brackets Supports	Correderas Gliders Glisseur	U	€	€	cm
E.91004	-	30	1		35,44 €	100
E.91504	-	48	1		50,68 €	150
E.92004	-	60	1		64,96 €	200
E.92504	-	78	1		80,86 €	250
E.93004	-	90	1		94,86 €	300
E.93504	-	108	1		123,08 €	350
E.94004	-	120	1		137,56 €	400
E.94504	-	138	1		152,82 €	450
E.95004	-	150	1		168,76 €	500
E.96004	-	180	1		203,32 €	600

Componentes / Components / Composants

Riel de aluminio
2 Vías
(73x13mm.)

Aluminium track
(73x13mm.) /
Rail aluminium
(73x13mm.)

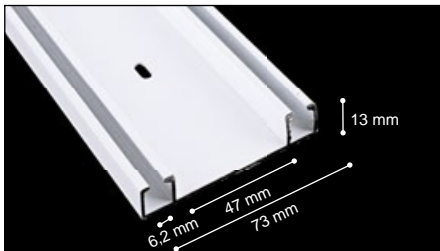

REF	∅	U	€	€	cm
C.12004BL		60 m	10,20 €	11,73 €	600

Riel de aluminio
3 Vías
(133x13mm.)

Aluminium track
(133x13mm.) /
Rail aluminium
(133x13mm.)

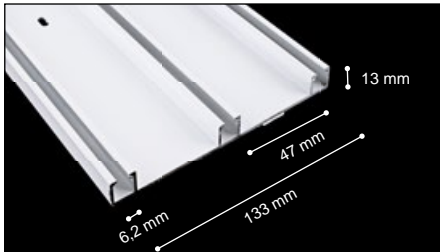

REF	∅	U	€	€	cm
C.12005BL		60 m	17,18 €	19,76 €	600

Riel de aluminio
ASIMÉTRICO
(104x13mm.)

Aluminium track
(104x13mm.) /
Rail aluminium
(104x13mm.)

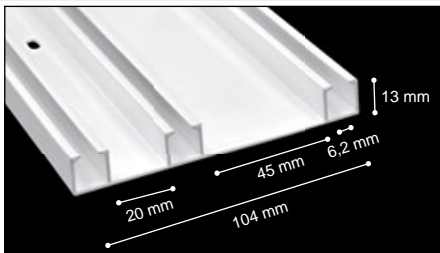

REF	∅	U	€	€	cm
C.12012BL		60 m	14,60 €	16,79 €	600

NEW

Riel de aluminio
4 Vías
(115x13mm.)

Aluminium track
(115x13mm.) /
Rail aluminium
(115x13mm.)

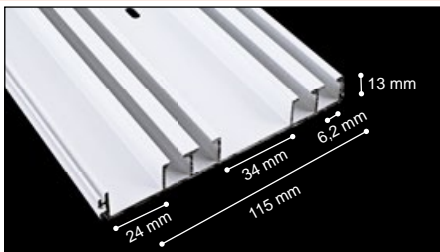

REF	∅	U	€	€	cm
C.12006BL		60 m	17,38 €	19,99 €	600

Perfil de aluminio
Icrado

Aluminium track
with bonded
Icro /
Rail alum. a c
Icro adapté



REF	∅	U	€	€	cm
C.12007BL		60 m	4,60 €	5,29 €	600

Corredera con
ruedas

Wheeled glider/
Glisseur a roue



REF	∅	U	€	€	cm
D.23		500	0,082 €	0,098 €	

Tapa con agujero
para gancho

End Cap /
Bouchon

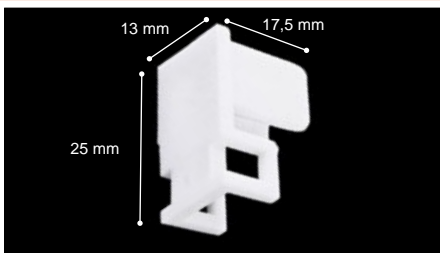

REF	∅	U	€	€	cm
D.47		50	0,56 €	0,67 €	

Conjunto corredera
maestra

Overlap master
carrier /
Porteur principal



REF	∅	U	€	€	cm
D.1001		50	2,48 €	2,98 €	

Componentes / Components / Composants

Tirador

Wand /
Lance rideau



REF	∅	U	€	€	cm
L.11		25	2,08 €	2,39 €	100
L.11150		25	3,22 €	3,70 €	150

Muestra riel
Múltiple

Demo sample
MULTIPLE track /
Echantillon
MULTIPLE rail

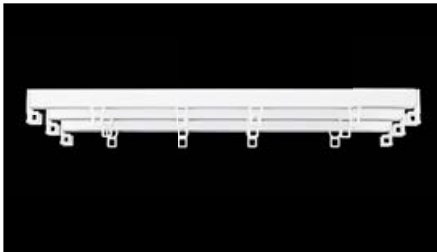

REF	∅	U	€	€	cm
M.303		1		11,24 €	



Somos españoles
y estamos muy cerca de ti



La tranquilidad
de confiar en el líder



Somos Fabricantes

Distribuimos
a los 5 continentes

Productos especiales para
proyectos de construcción

2 años de garantía
Ampliables

Departamento Técnico
a su disposición

Tenemos stock permanente
Rapidez en la fabricación

Empaquetado especial en
función de sus necesidades



altransolutions.es

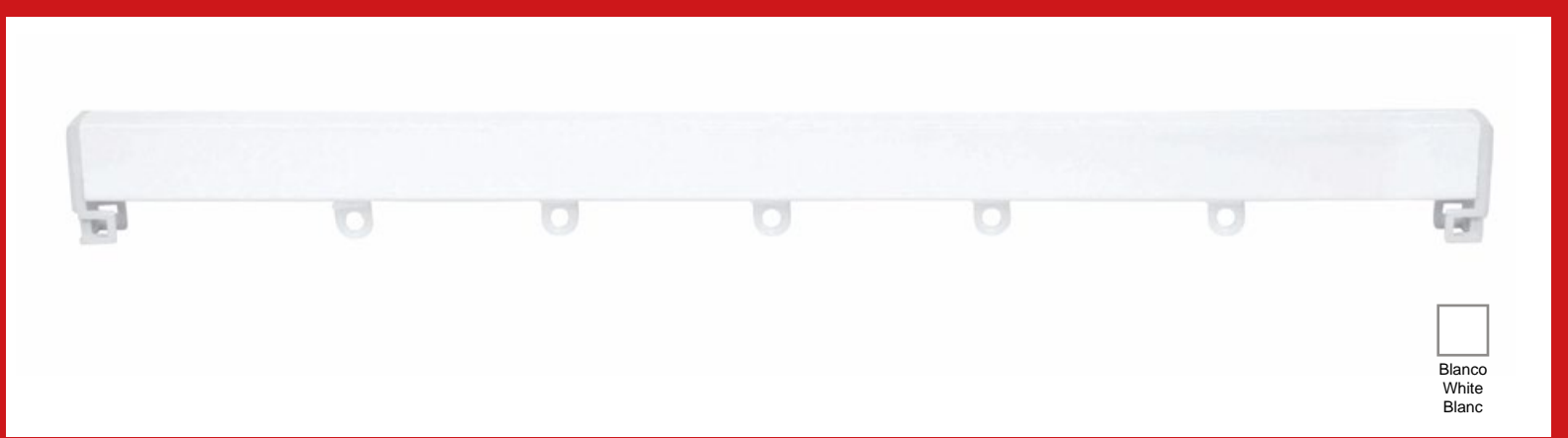

Blanco
White
Blanc



Ejemplo del riel montado con codos interior y exterior.



Ejemplo of the aluminium track assembled with inner and outer elbows. /
Exemple du rail monté avec des coudes intérieur et extérieur.

REVA MANUAL

Conjuntos completos con soporte a techo (I.202) / Complete sets with ceiling Bracket (I.202) / Kits complets avec support Plafond (I.202)

Disponibile con opción Cordón / Available with Cord System / Disponible avec option Corde

Incremento para Sistema Onda Perfecta
Price increase perfect wave system /
Hausse prix système onde parfaite

D.113: 3,30 €/m
D.114: 3,30 €/m

REF	Soportes Brackets Supports	Correderas Gliders Glisseur				
J.2100	2	10	6	9,68 €	11,13 €	100
J.2150	3	16	6	14,16 €	16,28 €	150
J.2200	3	20	6	17,80 €	20,47 €	200
J.2250	4	26	6	22,32 €	25,67 €	250
J.2300	4	30	6	25,94 €	29,83 €	300
J.2350	5	36	6	30,44 €	35,01 €	350
J.2400	5	40	6	34,08 €	39,19 €	400
J.2450	6	46	6	38,58 €	44,37 €	450
J.2500	6	50	6	42,22 €	48,55 €	500
J.2600	8	60	6	50,84 €	58,47 €	600

Componentes / Components / Composants

Perfil de aluminio blanco

Aluminium track / Profil blanc alum.

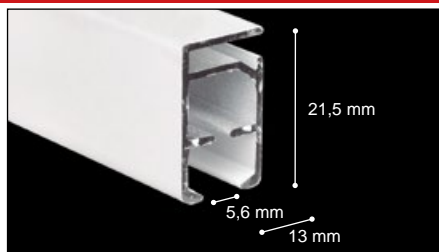

REF	\emptyset				
C.12141BL		60 m	5,68 €	6,53 €	600

Soporte techo

Ceiling bracket / Support plafond

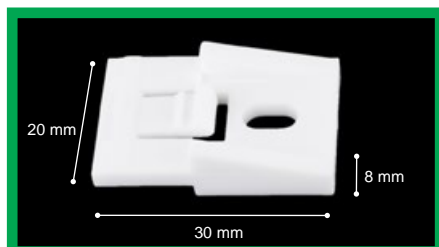

REF	\emptyset				
I.202		100	0,44 €	0,53 €	

* Soporte incluido en el kit / Bracket supplied in the kit / Support fourni dans le kit.

Componentes / Components / Composants

Tapa con agujero para gancho

End Cap / Bouchon

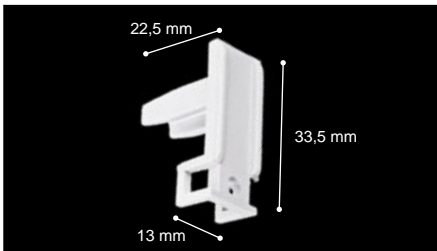

REF	Ø	U	€	€ ¹	cm
I.200		100	0,50 €	0,60 €	

Conjunto corredera maestra

Master carrier set / Kit porteur principal



REF	Ø	U	€	€ ¹	cm
I.206		25	2,42 €	2,78 €	

Corredera Maestra parte curva

Master carrier curved part / Porteur principal partie courbée



REF	Ø	U	€	€ ¹	cm
I.208		25	1,36 €	1,56 €	

Correderas

Glider / Glisseur

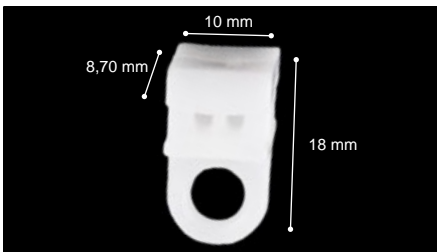

REF	Ø	U	€	€ ¹	cm
I.201		1000	0,166 €	0,199 €	

Empalme

Splice / Raccordeur

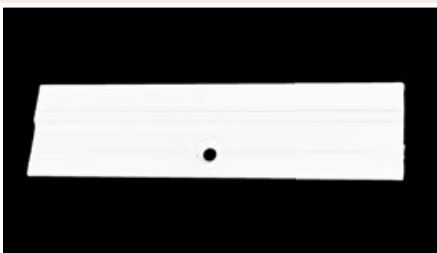

REF	Ø	U	€	€ ¹	cm
I.203		25	1,78 €	2,05 €	

Codo rincón 90°

90° Inner elbow / Coude interieur 90°

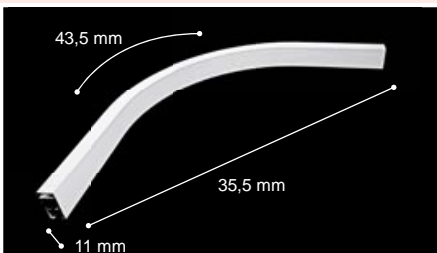

REF	Ø	U	€	€ ¹	cm
I.205		10	21,52 €	24,75 €	

Codo esquina 90°

90° Outer elbow / Coude extérieur 90°

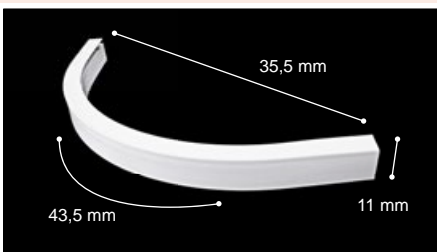

REF	Ø	U	€	€ ¹	cm
I.204		10	21,52 €	24,75 €	

Tirador

Wand / Lance rideau



REF	Ø	U	€	€ ¹	cm
L.11		25	2,08 €	2,39 €	100
L.11150		25	3,22 €	3,70 €	150

Componentes / Components / Composants

Soporte múltiple de pared ek rafuerte

Wall ek ension brack t (extrastrong) / Support mur ek rafort



REF	∅	U	€	€	cm
D.3001BL		25	3,46 €	3,98 €	7
D.3002BL		25	4,16 €	4,78 €	11
D.3003BL		25	4,94 €	5,68 €	15
D.3004BL		25	5,18 €	5,96 €	19
D.3005BL		25	5,38 €	6,19 €	23

Soporte múltiple de pared blanco

White wall ek ension brack t / Support blanc mural



REF	∅	U	€	€	cm
D.301BL		25	1,98 €	2,38 €	4
D.302BL		25	2,08 €	2,50 €	6
D.303BL		25	2,36 €	2,83 €	10
D.304BL		25	3,00 €	3,60 €	15
D.305BL		25	4,78 €	5,74 €	20

Muestra riel REVA MANUAL

Demo sample REVA Hand-Drawn track / Echantillon Rail REVA MANUELE

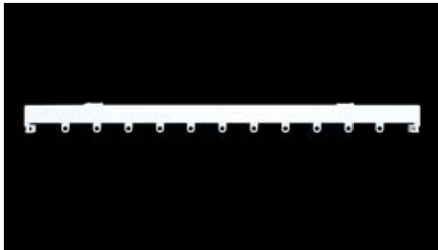

REF	∅	U	€	€	cm
M.2M		1		6,74 €	

REVA RAIL

manual & cord system

A Specialist for Specialists!!!



ALTRAN

WINDOW COVERING SOLUTIONS

Riel RM09 Manual / Hand-Drawn RM09 Track / Rail RM09 Manuel



Blanco
White
Blanc

RM09 MANUAL

Conjuntos completos con soporte a techo (J.R107) /

Complete sets with ceiling Bracket (J.R107) /

Kits complets avec support Plafond (J.R107)

* Se suministran empalmados /
* Supplied in 2 halves /
* Fourni en 2 parts.

Incremento para Sistema Onda Perfecta
Price increase perfect wave syst em
Hausse prix syst ème onde parfaite

D.115: 12,78 €/m
D.116: 12,78 €/m

REF	Soportes Brackets Supports	Correderas Gliders Glisseur	U	€	€	cm
J.R1500M	2	16	1		98,12 €	150
J.R2000M	3	20	1		113,66 €	200
J.R2500M	3	26	1		128,34 €	250
J.R3000M	4	30	1		143,88 €	300
J.R3500M	4	36	1		158,56 €	350
J.R4000M	5	40	1		182,74 €	400
J.R4500M	5	46	1		188,78 €	450
J.R5000M	6	50	1		204,32 €	500
J.R5500M	6	56	1		219,00 €	550
J.R6000M	7	60	1		234,52 €	600
J.R6500M*	7	66	1		249,22 €	650*
J.R7000M*	8	70	1		264,76 €	700*
J.R7500M*	8	76	1		277,28 €	750*
J.R8000M*	9	80	1		294,98 €	800*
J.R8500M*	9	86	1		309,66 €	850*
J.R9000M*	10	90	1		325,22 €	900*
J.R9500M*	10	96	1		339,92 €	950*
J.R10000M*	12	100	1		356,40 €	1000*

Información General / General Information / Informations Générales

El perfil es de aluminio lacado blanco.
El riel se suministra cortado a medida y preparado para el modo de apertura deseado: apertura izquierda, apertura derecha o apertura central.
Correderas con ruedas permiten un deslizamiento suave y fluido de la cortina.
Su largo máximo es de 12 metros mediante empalme.

The track profile is made of white anodized aluminium. The track is supplied cut-to-measure and assembled to the opening mode specified by the customer: left-side opening, right-side opening or central opening. Sliding wheels allow a smooth sliding curtain.
The maximum length of the track is 12 meters using a splice or joiner.

Le rail d'aluminium anodisé blanc.
Le rail est fourni coupé sur mesure avec le mode d'ouverture sollicité: à gauche, à droite ou centrale.
Roues coulissantes permettent un rideau coulissant fluide.
Le largeur maximum est de 12 mètres avec raccords.

- Disponible también para Sistema con ONDA PERFECTA empleando las referencias D.115 Corredera con Cordón de paso 60 mm y D.116 Corredera con Cordón con paso 80 mm. (Ref: J.115I ó J.116I = 12,78 € PVP).

- Also available with PERFECT WAVE SYSTEM, ref. D.115 Corded Glider space 60 mm and D.116 Corded Glider space 80 mm. (Ref: J.115I or J.116I = 12,78 € SRP).

- Aussi disponible avec le SYSTÈME D'ONDE PARFAITE, ref. D.115 Glisseur en Cordon pas 60 mm et D.116 Glisseur en Cordon pas 80 mm. (Ref: J.115I et J.116I = 12,78 € PVP).

- Disponible también para Sistema con CINTA ACORDEÓN empleando las referencias D.111 Cinta con Automáticos y D.112 Corredera con Cordón. (Ref: J.ROP = 7,20 € PVP)

- Available also for the RUFFLE TAPE SYSTEM by using references D.111 ruffle tape and D.112 corded runner (Ref: J.ROP = 7,20 € SRP)

- Disponible aussi avec l'option de RUBAN ACCORDÉON avec les références D.111 ruban accordéon et D.112 glisseur en cordon (Ref: J.ROP = 7,20 € PVP)

Observación Curvatura / Remark on Bending / Observation Cintrage



Curvatura RM09.

J.RC - curvatura por Ángulo - 86,52 €PVP
 J.RA - curvatura por Arco - 129,78 €PVP
 El Coste incluye el curvado, el empaquetado y el sobrecosto en el envío con respecto a un envío normal dentro de territorio peninsular español.
 Radio mínimo de curvatura: 35cm



BENDING RM09.

J.RC - bending in angle - 86,52 €SRP
 J.RA - bending in Arc - 129,78 €SRP
 The price includes the bending and the special packaging. The freight charges due to the special sizes will be charged by separate in the cases of shipments outside the Spanish mainland.
 Minimum bending radius: 35cm



CINTRAGE RM09.

J.RC - cintrage par angle - 86,52 €PVP
 J.RA - cintrage par Arc - 129,78 €PVP
 Le prix inclue le cintrage et l'emballage à cette fin. Les frais de transport par les dimensions enregistrées seront facturés séparément dans les éditions pour les envois non péninsulaires.
 Radius minimum de cintrage: 35cm



- En casos en los que haya 2 o más Curvas en forma de Arco o Ángulo con idéntico o diferente radio en el mismo riel, se servirá empleando empalmes para asegurar el deslizamiento correcto de las correderas por la zona de unión de los arcos. Cada arco se cobrará por separado al precio de 129,78 €PVP.
 - El cliente debe proporcionar SIEMPRE una plantilla con el arco y radio de la curvatura.
 En el caso de que el cliente no la aporte y tengamos que crearla en Altran, el importe será de 31,50 € PVP.



- In the case of 2 or more curvings in arch or angle, with radius same size of different in the same track, we will supply the track with joints in order to assure the correct slide of the runners in the area of union. Every arch will be invoice by separate, price 129,78 €SRP.
 - Client should **provide** the physical template with the arch and the radius of the bending.
 Altran offers the possibility of create the template price 31,50 € SPR.



- Dans le cas de 2 ou plus curves en forme d'arc ou angle, avec radius identique ou différent dans le même rail, on fournira le rail avec raccords pour sécuriser le glissement correct des glisseurs dans la zone de jonction des arcs. Chacun des arcs sera facturé séparément à un prix de 129,78 €PVP.
 - Le client **toujours** doit fournir le modèle en papier avec l'arc ou radius du cintrage.
 Altran offre la possibilité de créer le modèle en papier à un prix de 31,50 € PVP.

Componentes / Components / Composants

Perfil RM09

RM09 Track /
Rail RM09



REF	∅	U	€	€	cm
J.R101		1		20,40 €/m	600

Cantonera

End Pulley /
Bouchons Finaux

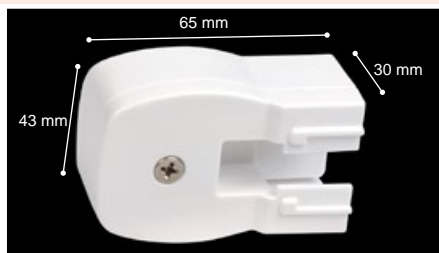

REF	∅	U	€	€	cm
J.R121		1		10,30 €	

NEW

Soporte Techo
Giratorio

Round Ceiling
Bracket /
Support Plafond

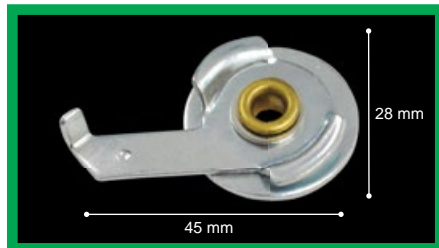

REF	∅	U	€	€	cm
J.R107		1		1,84 €	

* Soporte incluido en el kit / Bracket supplied in the kit / Support fourni dans le kit.

Soporte Techo
Extrafuerte

Ceiling Bracket
(Extrastrong) /
Support Plafond
Extrafort



REF	∅	U	€	€	cm
J.R108		1		2,92 €	

Observación Curvatura / Remark on Bending / Observation Cintrage

Bloqueo
Cantonera

End-Stop Screw /
Vis d'arrêt



REF	∅	U	€	1	cm
J.R104		1		1,22€	

Corredera Maestra

Master Carrier /
Porteur principal
ou croisement



REF	∅	U	€	1	cm
J.R105		1		10,10 €	

Corredera
con ruedas

Wheeled Runner /
Glisseur à croue

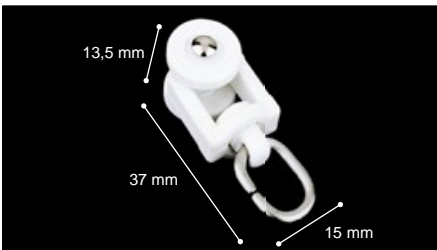

REF	∅	U	€	1	cm
J.R106		1		0,514 €	

Gancho Fijo
Cantonera

Static Hook
End-Pulley /
Crochet Fixe



REF	∅	U	€	1	cm
J.R110		1		0,26 €	

Corredera con Cordón
de paso 60 mm
con ruedas
y onda perfecta

Cordé wheelé wæ
runner 60 mm /
Glisseur cordon à c
roue pour onde
parfaite pas 60 mm

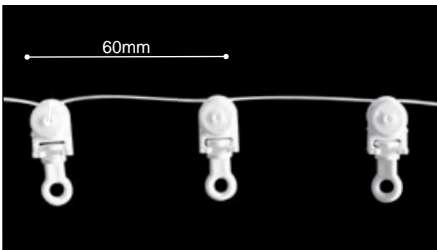

REF	∅	U	€	1	cm
D.115		1		17,64 €/m	

Corredera con Cordón
de paso 80 mm
con ruedas
y onda perfecta

Cordé wheelé wæ
runner 80 mm /
Glisseur cordon à c
roue pour onde
parfaite pas 80 mm

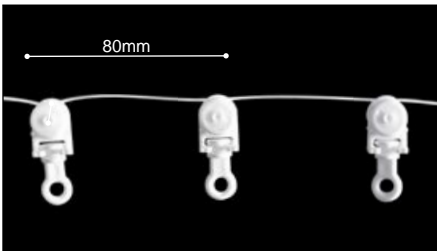

REF	∅	U	€	1	cm
D.116		1		17,64 €/m	

Corredera recomendada para los sistemas motorizados por su resultado estético /
Recommended runner option for the motorized system for aesthetic reasons /
Option de glisseur recommandée pour les systèmes motorisés pour son résultat esthétique.



ALTRAN[®]

CURTAIN DECORATION SYSTEMS

Rieles a Cordón

cord-drawn curtain tracks / rails tirage cordon



Rieles
Cordón



ALTRAN[®]
SISTEMAS PARA DECORAR CORTINAS



En Altran contamos con tantas soluciones para decorar cortinas como opciones de ventanas existen



RM09 MANUAL

Conjuntos completos con soporte a techo (J.R107) /

Complete sets with ceiling Bracket (J.R107) /

Kits complets avec support Plafond (J.R107)

- * Se sirven empalmados /
- * Supplied in 2 halves /
- * Fourni en 2 parts.

Incremento para Sistema Onda Perfecta
Price increase perfect wave syst em
Hausse prix syst ème onde parfaite

- D.115: 12,78 €/m
- D.116: 12,78 €/m

REF	Soportes Brackets Supports	Correderas Gliders Glisseur				
J.R1500C	2	16	1		198,18 €	150
J.R2000C	3	20	1		212,96 €	200
J.R2500C	3	26	1		226,96 €	250
J.R3000C	4	30	1		241,76 €	300
J.R3500C	4	36	1		255,76 €	350
J.R4000C	5	40	1		270,54 €	400
J.R4500C	5	46	1		284,54 €	450
J.R5000C	6	50	1		299,32 €	500
J.R5500C	6	56	1		313,32 €	550
J.R6000C	7	60	1		335,38 €	600
J.R6500C*	7	66	1		349,40 €	650*
J.R7000C*	8	70	1		364,16 €	700*
J.R7500C*	8	76	1		378,16 €	750*
J.R8000C*	9	80	1		392,96 €	800*
J.R8500C*	9	86	1		406,96 €	850*
J.R9000C*	10	90	1		421,74 €	900*
J.R9500C*	10	96	1		435,94 €	950*
J.R10000C*	11	100	1		450,52 €	1000*

Información General / General Information / Informations Générales

El perfil es de aluminio lacado blanco. El riel a cordón se sirve cortado a medida y preparado para el modo de apertura deseado: apertura izquierda, apertura derecha o apertura central. Correderas con ruedas permiten un deslizamiento suave y fluido de la cortina. Su largo máximo es de 12 metros mediante empalme.

The track profile is made of white anodized aluminium. The cord track is supplied cut-to-measure and assembled to the opening mode specified by the customer: left-side opening, right-side opening or central opening. Sliding wheels allow a smooth sliding curtain. The maximum length of the track is 12 meters using a splice or joiner.

Le rail d'aluminium anodisé blanc. Le rail avec corde est fourni coupé sur mesure avec le mode d'ouverture sollicité: vers la gauche, vers la droite ou centrale. Roues coulissantes permettent un rideau coulissant lisse et fluide. Le largeur maximum est de 12 mètres avec raccords.

- Disponible también para Sistema con ONDA PERFECTA empleando las referencias D.115 Corredera con Cordón de paso 60 mm y D.116 Corredera con Cordón con paso 80 mm. (Ref: J.115I ó J.116I = 12,78 € PVP).

- Also available with PERFECT WAVE SYSTEM, ref. D.115 Corded Glider space 60 mm and D.116 Corded Glider space 80 mm. (Ref: J.115I or J.116I = 12,78 € SRP).

- Aussi disponible avec le SYSTÈME D'ONDE PARFAITE, ref. D.115 Glisseur en Cordon pas 60 mm et D.116 Glisseur en Cordon pas 80 mm. (Ref: J.115I et J.116I = 12,78 € PVP).

- Disponible también para Sistema con CINTA ACORDEÓN empleando las referencias D.111 Cinta con Automáticos y D.112 Corredera con Cordón. (Ref: J.ROP = 7,20 € PVP)

- Available also for the RUFFLE TAPE SYSTEM by using references D.111 ruffle tape and D.112 corded runner (Ref: J.ROP = 7,20 € SRP)

- Disponible aussi avec l'option de RUBAN ACCORDÉON avec les références D.111 ruban accordéon et D.112 glisseur en cordon (Ref: J.ROP = 7,20 € PVP)

Observación Curvatura / Remark on Bending / Observation Cintrage

Curvatura RM09.

J.RC - curvatura por Ángulo - 86,52 € PVP
 J.RA - curvatura por Arco - 129,78 € PVP
 El Coste incluye el curvado, el empaquetado y el sobrecosto en el envío con respecto a un envío normal dentro de territorio peninsular español.
 Radio mínimo de curvatura: 35cm

BENDING RM09.

J.RC - bending in angle - 86,52 € SRP
 J.RA - bending in Arc - 129,78 € SRP
 The price includes the bending and the special packing. The freight charges due to the special sizes will be charged by separate in the cases of shipments outside the Spanish mainland.
 Minimum bending radius: 35cm

CINTRAGE RM09.

J.RC - cintrage par angle - 86,52 € PVP
 J.RA - cintrage par Arc - 129,78 € PVP
 Le prix inclue le cintrage et l'emballage à cette fin. Les frais de transport par les dimensions enregistrées seront facturés séparément dans les expéditions pour les envois non péninsulaires.
 Radius minimum de cintrage: 35cm

- En casos en los que haya 2 o más Curvas en forma de Arco o Ángulo con idéntico o diferente radio en el mismo riel, se servirá empleando empalmes para asegurar el deslizamiento correcto de las correderas por la zona de unión de los arcos. Cada arco se cobrará por separado al precio de 129,78 € PVP.

- El cliente debe proporcionar SIEMPRE una plantilla con el arco y radio de la curvatura.

En el caso de que el cliente no la aporte y tengamos que crearla en Altran, el importe será de 31,50 € PVP.

- In the case of 2 or more curvings in arch or angle, with radius same size of different in the same track, we will supply the track with joints in order to assure the correct slide of the runners in the area of union. Every arch will be invoice by separate, price 129,78 € SRP.

- Client should **provide** the physical template with the arch and the radius of the bending.

Altran offers the possibility of create the template price 31,50 € SPR.

- Dans le cas de 2 ou plus curves en forme d'arc ou angle, avec radius identique ou différent dans le même rail, on fournira le rail avec raccords pour sécuriser le glissement correct des glisseurs dans la zone de jonction des arcs. Chacun des arcs sera facturé séparément à un prix de 129,78 € PVP.

- Le client **toujours** doit fournir le modèle en papier avec l'arc ou radius du cintrage.

Altran offre la possibilité de créer le modèle en papier à un prix de 31,50 € PVP.

Componentes / Components / Composants

Perfil RM09

RM09 Track / Rail RM09



REF	Ø	U	€	€	cm
J.R101		1		20,40 €/m	600

Juego Cantonera para cordón

Kit Cord End Pulley / Embout tirage cordon



REF	Ø	U	€	€	cm
J.R119		1		80,34 €	

NEW

* Incluye terminal derecho e izquierdo /

Includes right and left end pulley / Embouts pour côté droite et gauche inclus

Soporte Techo Giratorio

Round Ceiling Bracket / Support Plafond

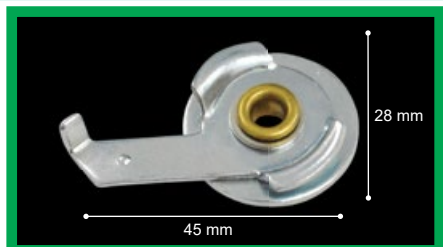

REF	Ø	U	€	€	cm
J.R107		1		1,84 €	

* Soporte incluido en el kit / Bracket supplied in the kit / Support fourni dans le kit.







Soporte Techo Extrafuerte

Ceiling Bracket (Extrastrong) / Support Plafond Extrafort

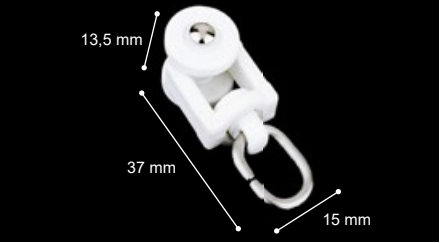

REF	Ø	U	€	€	cm
J.R108		1		2,92 €	

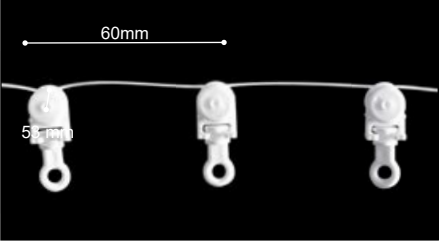
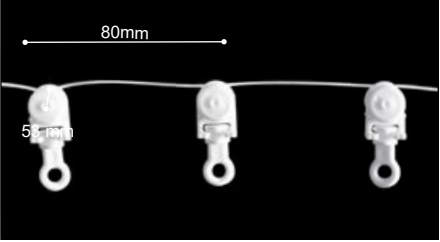
Observación Curvatura / Remark on Bending / Observation Cintrage

<p>Bloqueo Cantонера</p> <p>End-Pulley Stop / Frein Rail</p>		<table border="1"> <thead> <tr> <th>REF</th> <th>∅</th> <th>U</th> <th>€</th> <th>€</th> <th>cm</th> </tr> </thead> <tbody> <tr> <td>J.R104</td> <td></td> <td>1</td> <td></td> <td>1,22 €</td> <td></td> </tr> </tbody> </table>	REF	∅	U	€	€	cm	J.R104		1		1,22 €													
REF	∅	U	€	€	cm																					
J.R104		1		1,22 €																						
<p>Corredera Maestra</p> <p>Master Carrier / Chariot de Croisement</p>		<table border="1"> <thead> <tr> <th>REF</th> <th>∅</th> <th>U</th> <th>€</th> <th>€</th> <th>cm</th> </tr> </thead> <tbody> <tr> <td>J.R105</td> <td></td> <td>1</td> <td></td> <td>10,10 €</td> <td></td> </tr> </tbody> </table>	REF	∅	U	€	€	cm	J.R105		1		10,10 €													
REF	∅	U	€	€	cm																					
J.R105		1		10,10 €																						
<p>Corredera con ruedas</p> <p>Wheeled Runner / Glisseur avec roue</p>		<table border="1"> <thead> <tr> <th>REF</th> <th>∅</th> <th>U</th> <th>€</th> <th>€</th> <th>cm</th> </tr> </thead> <tbody> <tr> <td>J.R106</td> <td></td> <td>1</td> <td></td> <td>0,514 €</td> <td></td> </tr> </tbody> </table>	REF	∅	U	€	€	cm	J.R106		1		0,514 €													
REF	∅	U	€	€	cm																					
J.R106		1		0,514 €																						
<p>Empalme</p> <p>Splice / Raccordeur</p>		<table border="1"> <thead> <tr> <th>REF</th> <th>∅</th> <th>U</th> <th>€</th> <th>€</th> <th>cm</th> </tr> </thead> <tbody> <tr> <td>J.R109</td> <td></td> <td>1</td> <td></td> <td>6,84 €</td> <td></td> </tr> </tbody> </table>	REF	∅	U	€	€	cm	J.R109		1		6,84 €													
REF	∅	U	€	€	cm																					
J.R109		1		6,84 €																						
<p>Tirador</p> <p>Wand / Lance rideau</p>		<table border="1"> <thead> <tr> <th>REF</th> <th>∅</th> <th>U</th> <th>€</th> <th>€</th> <th>cm</th> </tr> </thead> <tbody> <tr> <td>L.11</td> <td></td> <td>25</td> <td>2,08 €</td> <td>2,39 €</td> <td>100</td> </tr> <tr> <td>L.11150</td> <td></td> <td>25</td> <td>3,22 €</td> <td>3,70 €</td> <td>150</td> </tr> </tbody> </table>	REF	∅	U	€	€	cm	L.11		25	2,08 €	2,39 €	100	L.11150		25	3,22 €	3,70 €	150						
REF	∅	U	€	€	cm																					
L.11		25	2,08 €	2,39 €	100																					
L.11150		25	3,22 €	3,70 €	150																					
<p>Corredera con Cordón de paso 60 mm con ruedas y onda perfecta</p> <p>Corded wheeled wave runner 60 mm / Glisseur cordon avec roue pour onde parfaite pas 60 mm</p>		<table border="1"> <thead> <tr> <th>REF</th> <th>∅</th> <th>U</th> <th>€</th> <th>€</th> <th>cm</th> </tr> </thead> <tbody> <tr> <td>D.115</td> <td></td> <td>1</td> <td></td> <td>17,64 €/m</td> <td></td> </tr> </tbody> </table>	REF	∅	U	€	€	cm	D.115		1		17,64 €/m													
REF	∅	U	€	€	cm																					
D.115		1		17,64 €/m																						
<p>Corredera con Cordón de paso 80 mm con ruedas y onda perfecta</p> <p>Corded wheeled wave runner 80 mm / Glisseur cordon avec roue pour onde parfaite pas 80 mm</p>		<table border="1"> <thead> <tr> <th>REF</th> <th>∅</th> <th>U</th> <th>€</th> <th>€</th> <th>cm</th> </tr> </thead> <tbody> <tr> <td>D.116</td> <td></td> <td>1</td> <td></td> <td>17,64 €/m</td> <td></td> </tr> </tbody> </table>	REF	∅	U	€	€	cm	D.116		1		17,64 €/m													
REF	∅	U	€	€	cm																					
D.116		1		17,64 €/m																						
<p>Rollo Cordón 3,5mm.</p> <p>Roll Cord / Rouleau Corde</p>		<table border="1"> <thead> <tr> <th>REF</th> <th>∅</th> <th>U</th> <th>€</th> <th>€</th> <th>cm</th> </tr> </thead> <tbody> <tr> <td>D.036GR</td> <td></td> <td>1</td> <td></td> <td>55,14 €</td> <td></td> </tr> <tr> <td>D.036</td> <td></td> <td>1</td> <td></td> <td>68,38 €</td> <td></td> </tr> <tr> <td>D.036BC</td> <td></td> <td>1</td> <td></td> <td>71,34 €</td> <td></td> </tr> </tbody> </table>	REF	∅	U	€	€	cm	D.036GR		1		55,14 €		D.036		1		68,38 €		D.036BC		1		71,34 €	
REF	∅	U	€	€	cm																					
D.036GR		1		55,14 €																						
D.036		1		68,38 €																						
D.036BC		1		71,34 €																						

Observación Curvatura / Remark on Bending / Observation Cintrage

Contrapeso Cordón

Cordweight /
Contrepoids cordon



REF	∅				
I.1150		25	1,52 €	1,82 €	

Contrapeso mini blanco (43 g aprox.)

Mini-cordweight white /
Mini-contrepoids blanc

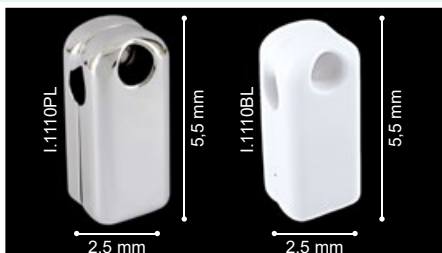

REF	∅				
I.1110BL		25	1,40 €	1,61 €	
I.1110PL		25	2,12 €	2,44 €	

Contrapeso (23 g aprox.)

Mini-cordweight /
Mini-contrepoids

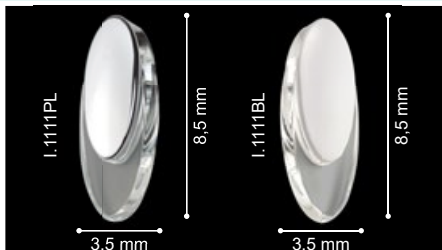

REF	∅				
I.1111BL		25	1,18 €	1,36 €	
I.1111PL		25	2,46 €	2,83 €	

NEW

Soporte múltiple de pared blanco

White wall extension bracket /
Support blanc mural



REF	∅				
D.301BL		25	1,98 €	2,38 €	4
D.302BL		25	2,08 €	2,50 €	6
D.303BL		25	2,36 €	2,83 €	10
D.304BL		25	3,00 €	3,60 €	15
D.305BL		25	4,78 €	5,74 €	20

Soporte Múltiple de Pared Extrafuerte

Wall Extension Bracket (Extrastrong) /
Support Mural Extrafort



REF	∅				
D.3001BL		25	3,46 €	3,98 €	7
D.3002BL		25	4,16 €	4,78 €	11
D.3003BL		25	4,94 €	5,68 €	15
D.3004BL		25	5,18 €	5,96 €	19
D.3005BL		25	5,38 €	6,19 €	23

Riel de aluminio REVA Cordón / REVA cord-drawn Aluminium track / Rail REVA d'aluminium avec tirage Corde

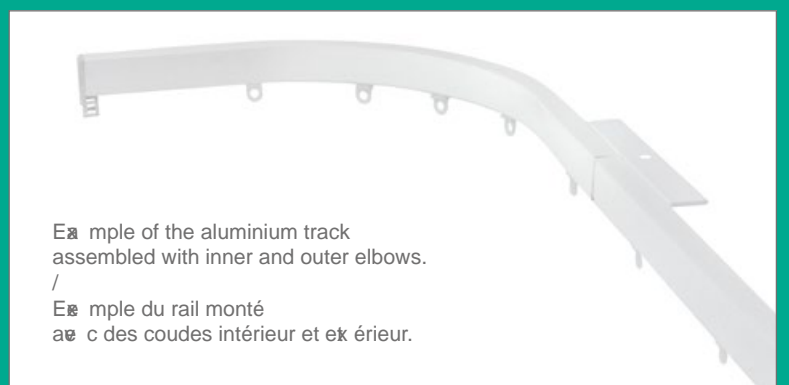

REVA CORDÓN	REF	Soportes Brackets Supports	Correderas Gliders Glisseur				
	Conjuntos completos con soporte a techo (I.202) / Complete sets with ceiling Bracket (I.202) / Kits complets avec support Plafond (I.202)	J.3100	0	10	6	21,38 €	24,59 €
Disponibles con opción Manual / Available with Manual System / Disponibles avec option Manuel	J.3150	1	16	6	27,14 €	31,21 €	150
	J.3200	1	20	6	31,84 €	36,62 €	200
	J.3250	2	26	6	37,56 €	43,19 €	250
	J.3300	2	30	6	43,52 €	50,05 €	300
	J.3350	3	36	6	49,40 €	56,81 €	350
	J.3400	3	40	6	55,82 €	64,19 €	400
	J.3450	4	46	6	61,84 €	71,12 €	450
	J.3500	4	50	6	66,86 €	76,89 €	500
	J.3600	6	60	6	80,62 €	92,71 €	600
	Incremento para Sistema Onda Perfecta Price increase perfect wave system Hausse prix système onde parfaite	D.113: 3,30 €/m D.114: 3,30 €/m					

Componentes / Components / Composants

Perfil de aluminio blanco

Aluminium track / Profil blanc alum.

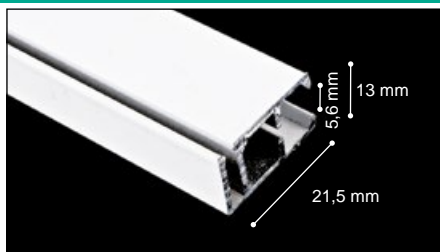

REF					
C.12141BL		60 m	5,68 €/m	6,53 €/m	600

Soporte techo

Ceiling bracket / Support plafond

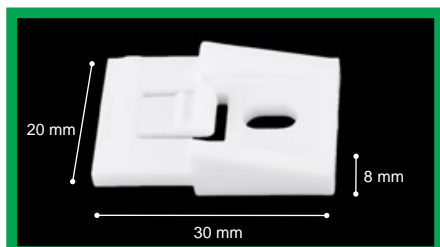

REF					
I.202		100	0,44 €	0,53 €	

* Soporte incluido en el kit / Bracket supplied in the kit / Support fourni dans le kit.

Componentes / Components / Composants

<p>Conjunto corredera maestra</p> <p>Master carrier set / Kit porteur principal</p>		<table border="1"> <thead> <tr> <th>REF</th> <th>∅</th> <th>U</th> <th>€</th> <th>€</th> <th>cm</th> </tr> </thead> <tbody> <tr> <td>I.206</td> <td></td> <td>25</td> <td>2,42 €</td> <td>2,78 €</td> <td></td> </tr> </tbody> </table>	REF	∅	U	€	€	cm	I.206		25	2,42 €	2,78 €							
REF	∅	U	€	€	cm															
I.206		25	2,42 €	2,78 €																
<p>Corredera Maestra parte cura</p> <p>Master carrier cured part / Porteur principal</p>		<table border="1"> <thead> <tr> <th>REF</th> <th>∅</th> <th>U</th> <th>€</th> <th>€</th> <th>cm</th> </tr> </thead> <tbody> <tr> <td>I.208</td> <td></td> <td>25</td> <td>1,36 €</td> <td>1,56 €</td> <td></td> </tr> </tbody> </table>	REF	∅	U	€	€	cm	I.208		25	1,36 €	1,56 €							
REF	∅	U	€	€	cm															
I.208		25	1,36 €	1,56 €																
<p>Correderas</p> <p>Glider / Glisseur</p>		<table border="1"> <thead> <tr> <th>REF</th> <th>∅</th> <th>U</th> <th>€</th> <th>€</th> <th>cm</th> </tr> </thead> <tbody> <tr> <td>I.201</td> <td></td> <td>1000</td> <td>0,166 €</td> <td>0,199 €</td> <td></td> </tr> </tbody> </table>	REF	∅	U	€	€	cm	I.201		1000	0,166 €	0,199 €							
REF	∅	U	€	€	cm															
I.201		1000	0,166 €	0,199 €																
<p>Empalme</p> <p>Splice / Raccordeur</p>		<table border="1"> <thead> <tr> <th>REF</th> <th>∅</th> <th>U</th> <th>€</th> <th>€</th> <th>cm</th> </tr> </thead> <tbody> <tr> <td>I.203</td> <td></td> <td>25</td> <td>1,78 €</td> <td>2,05 €</td> <td></td> </tr> </tbody> </table>	REF	∅	U	€	€	cm	I.203		25	1,78 €	2,05 €							
REF	∅	U	€	€	cm															
I.203		25	1,78 €	2,05 €																
<p>Juego de cantoneras</p> <p>End pulley set / Embouts tirage cordon pair</p>		<table border="1"> <thead> <tr> <th>REF</th> <th>∅</th> <th>U</th> <th>€</th> <th>€</th> <th>cm</th> </tr> </thead> <tbody> <tr> <td>I.207</td> <td></td> <td>25</td> <td>2,84 €</td> <td>3,27 €</td> <td></td> </tr> </tbody> </table> <p>* Las cantoneras tienen un diseño especial para ser utilizadas como soporte y así reducir el número de soportes empleados. / The end pulley has a special design aiming to reduce the number of brackets to be used. / Les plaques de couche ont un dessin spécial pour réduire le nombre de supports à être employés.</p>	REF	∅	U	€	€	cm	I.207		25	2,84 €	3,27 €							
REF	∅	U	€	€	cm															
I.207		25	2,84 €	3,27 €																
<p>Codo rincón 90°</p> <p>90° Inner elbow / Coude intérieur 90°</p>		<table border="1"> <thead> <tr> <th>REF</th> <th>∅</th> <th>U</th> <th>€</th> <th>€</th> <th>cm</th> </tr> </thead> <tbody> <tr> <td>I.205</td> <td></td> <td>10</td> <td>21,52 €</td> <td>24,75 €</td> <td></td> </tr> </tbody> </table>	REF	∅	U	€	€	cm	I.205		10	21,52 €	24,75 €							
REF	∅	U	€	€	cm															
I.205		10	21,52 €	24,75 €																
<p>Codo esquina 90°</p> <p>90° Outer elbow / Coude extérieur 90°</p>		<table border="1"> <thead> <tr> <th>REF</th> <th>∅</th> <th>U</th> <th>€</th> <th>€</th> <th>cm</th> </tr> </thead> <tbody> <tr> <td>I.204</td> <td></td> <td>10</td> <td>21,52 €</td> <td>24,75 €</td> <td></td> </tr> </tbody> </table>	REF	∅	U	€	€	cm	I.204		10	21,52 €	24,75 €							
REF	∅	U	€	€	cm															
I.204		10	21,52 €	24,75 €																
<p>Rollo 500 m de cordón 2,7 mm (D.12P) y 3 mm (D.12)</p> <p>Cord roll (500 m) 2,7 mm & 3 mm / Rouleau 500 m corde 2,7 mm et 3 mm.</p>		<table border="1"> <thead> <tr> <th>REF</th> <th>∅</th> <th>U</th> <th>€</th> <th>€</th> <th>cm</th> </tr> </thead> <tbody> <tr> <td>D.12</td> <td></td> <td>1</td> <td>67,60 €</td> <td></td> <td>500</td> </tr> <tr> <td>D.12P</td> <td></td> <td>1</td> <td>116,40 €</td> <td></td> <td>500</td> </tr> </tbody> </table>	REF	∅	U	€	€	cm	D.12		1	67,60 €		500	D.12P		1	116,40 €		500
REF	∅	U	€	€	cm															
D.12		1	67,60 €		500															
D.12P		1	116,40 €		500															

Componentes / Components / Composants

Tensor sencillo

Cord guide /
Guide de corde



REF	∅	U	€	1	cm
I.8		50	0,42 €	0,50 €	

Contrapeso Cordón

Cordweight /
Contrepoids cordon



REF	∅	U	€	1	cm
I.1150		25	1,52 €	1,82 €	

Contrapeso mini
(43 g aprox.)

Mini-cordweight /
Mini-contrepoids

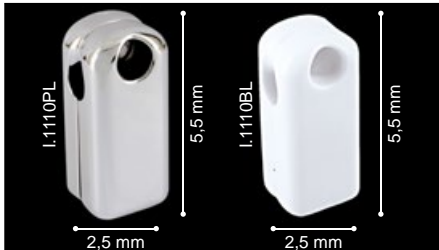

REF	∅	U	€	1	cm
I.1110BL		25	1,40 €	1,61 €	
I.1110PL		25	2,12 €	2,44 €	

Contrapeso
(23 g aprox.)

Mini-cordweight /
Mini-contrepoids

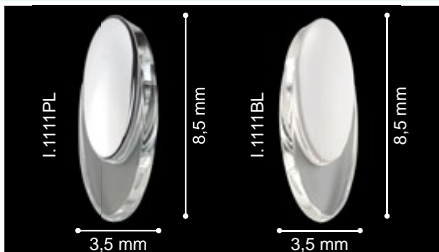

REF	∅	U	€	1	cm
I.1111BL		25	1,18 €	1,36 €	
I.1111PL		25	2,46 €	2,83 €	

NEW

Tirador

Wand /
Lance rideau



REF	∅	U	€	1	cm
L.11		25	2,08 €	2,39 €	100
L.11150		25	3,22 €	3,70 €	150

Soporte múltiple de
pared ek rafuerte

Wall ek ension
brack t
(extrastrong) /
Support mur
ek rafort



REF	∅	U	€	1	cm
D.3001BL		25	3,46 €	3,98 €	7
D.3002BL		25	4,16 €	4,78 €	11
D.3003BL		25	4,94 €	5,68 €	15
D.3004BL		25	5,18 €	5,96 €	19
D.3005BL		25	5,38 €	6,19 €	23

Soporte múltiple de
pared blanco

White wall
ek ension brack t /
Support blanc
mural



REF	∅	U	€	1	cm
D.301BL		25	1,98 €	2,38 €	4
D.302BL		25	2,08 €	2,50 €	6
D.303BL		25	2,36 €	2,83 €	10
D.304BL		25	3,00 €	3,60 €	15
D.305BL		25	4,78 €	5,74 €	20

Muestra REVA
CORDÓN

Demo sample
Rea CORD track /
Echantillon
kt Rea CORDON

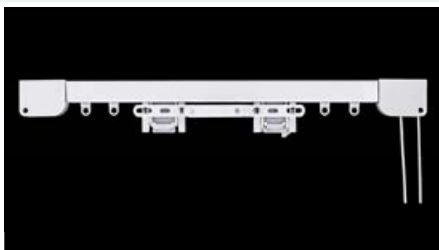

REF	∅	U	€	1	cm
M.2		1		13,72 €	

Riel EXTENSIBLE SERIE 1100 a Cordón / EXTENDIBLE Cord track Serie 1100 / Rail EXTENSIBLE avec Corde Serie 1100



Riel EXTENSIBLE hierro Serie 1100 A TECHO /
Iron extendible rail 1100 range with CEILING installation /
Rail extendible en fer série 1100 avec installation PLAFOND.

Blanco
White
Blanc

EXTENSIBLE	REF	Soporte Techo Ceiling Brackets / Support Plafond		Correderas Gliders Glisseur	U	€	€	cm
		L.100I (Int.)	L.100E (Int.)					
Kit completo con accesorios para montaje A TECHO /	J.G3821R	0	0	10	20	11,46 €	13,18 €	70-125
Complete kit with CEILING accessories /	J.G3823R	0	0	12	20	12,70 €	14,61 €	90-156
Kit complet avec accessoires de PLAFOND	J.G3825R	0	1	24	20	16,58 €	19,07 €	140-256
	J.G3826R	1	1	36	20	20,42 €	23,48 €	190-356
	J.G3827R	1	2	46	10	24,90 €	28,64 €	240-456



Riel EXTENSIBLE hierro Serie 1100 A FRENTE /
Iron extendible rail 1100 range with WALL installation. /
Rail extendible en fer série 1100 avec installation MUR.

Blanco
White
Blanc

EXTENSIBLE	REF	Soporte Lateral Wall Bracket / Support Mural	Soporte Techo Ceiling Brackets / Support Plafond		Correderas Gliders Glisseur	U	€	€	cm
			L.10 (Int.)	L.20I (Int.)					
Kit completo con accesorios para montaje a frente /	J.G3821	2	0	0	10	20	13,14 €	15,11 €	70-125
Complete kit with WALL accessories /	J.G3823	2	0	0	12	20	14,64 €	16,84 €	90-156
Kit complet avec accessoires de MURAL	J.G3825	2	0	1	24	20	19,10 €	21,97 €	140-256
	J.G3826	2	1	1	36	20	23,84 €	27,42 €	190-356
	J.G3827	2	1	2	46	10	29,06 €	33,42 €	240-456

Las cantoneras tienen un diseño especial para ser utilizadas como soporte y así reducir el número de soportes empleados.

The end pulleys have a special design aiming to reduce the number of brackets to be used. /

Les plaques de couche ont un dessin spécial pour réduire le nombre de supports à être employés.

Componentes / Components / Composants

Soporte lateral sencillo 70 mm.

Single wall bracket 70 mm. / Support mural 70 mm.



REF	∅	U	€	€	cm
I.10		20 pares	2,42 €	2,90 €	

* Soporte incluido en el kit / Bracket supplied in the kit / Support fourni dans le kit.

Soporte lateral doble 100 mm.

Double wall bracket 100 mm. / Support mural double 100 mm.



REF	∅	U	€	€	cm
I.1		20 pares	3,46 €	4,15 €	

Soporte central sencillo 80 mm. Interior y Exterior

Single intermediate bracket (Int. & Ext.) / Support intermediaire 80 mm.(Int. et Ext.)



REF	∅	U	€	€	cm
I.20I		20	1,68 €	2,02 €	
I.20E		20	1,68 €	2,02 €	

* Soporte incluido en el kit / Bracket supplied in the kit / Support fourni dans le kit.

Soporte central doble 100 mm. (interior)

Double intermediate bracket 100mm.(int) / Double support intermediaire 100 mm. (int)



REF	∅	U	€	€	cm
I.21		20	2,10 €	2,52 €	

Soporte central doble 100 mm. (exterior)

Double intermediate bracket 100mm(ext.) / Double support intermediaire 100 mm. (ext)



REF	∅	U	€	€	cm
I.2E		20	2,12 €	2,52 €	

Soporte techo sencillo 20mm (interior)

Single Ceiling Support 20mm. (interior) / Support plafond 20mm. (interieur)



REF	∅	U	€	€	cm
I.100I		20	0,80 €	0,96 €	

* Soporte incluido en el kit / Bracket supplied in the kit / Support fourni dans le kit.

Soporte techo sencillo 20mm (exterior)

Single ceiling Support 20mm. (ext.) / Support plafond 20mm. (exterieur)



REF	∅	U	€	€	cm
I.100E		20	0,80 €	0,96 €	

* Soporte incluido en el kit / Bracket supplied in the kit / Support fourni dans le kit.

Tensor perilla

Cord weighted tassel / Gland pour corde



REF	∅	U	€	€	cm
I.9		50	1,20 €	1,44 €	



ALTRAN[®]

CURTAIN DECORATION SYSTEMS

Rieles Motorizados

motorized curtain tracks / rails motorisés



Rieles Motorizados con aplicación doméstica



RM09-43

**Batería recargable
con energía solar.**



*No incluye mandos.

Dependiendo del motor elegido para domotizar el sistema RM09, necesitaremos emplear o no, el cable telefónico con conector RJ9 (no incluido), independientemente de si se instala con o sin el pulsador J.R112. /

*Do not include remote control. Depending on the motor chosen for the home automation use of the RM09 system, a telephone cord with RJ9 plug (not included) will be needed or not, regardless of the installation with or without the wall switch J.R112. /

Télécommande ne pas compris. En fonction du moteur choisi pour l'utilisation domotique du système RM09, le cordon téléphonique avec connecteur RJ9 (non compris) sera nécessaire ou non, indépendamment de l'installation avec ou sans interrupteur mural J.R112.



 El Riel Motorizado es un sistema para desplazar las cortinas mediante el uso de un mando a distancia o de un pulsador. Puede conectarse a un sistema domótico.

Las opciones en motores que ponemos a tu disposición cubren cualquier necesidad existente en la decoración de un hogar, oficina o incluso en teatros como ya se ha empleado para los telones. La calidad del aluminio del Riel RM09 y de los Motores, le permite al instalador o decorador emplear confeccionar cortinas de un peso alto. Además el perfil del riel permite curvarse lo que aumenta las posibilidades de este excelente producto número uno en ventas por su precio, su versatilidad y su resistencia.

Los 5 motores exclusivos para emplear en rieles, disponen de diferentes potencias, diferentes sistemas para conectarse a la domótica del hogar incluso diferentes opciones de carga como la eléctrica o la solar (más acorde con las energías renovables y las necesidades ecológicas actuales).

 The motorized track is a system to slide curtains through the use of a remote control or a wall switch. Can be connected to a smart home automation system. The multiple options we make available cover all domestic decoration needs, moreover offices or even theatres as we have already done with the automation of backdrops. The quality of the RM09 track and the motorized systems permit the Installer or Decorators to be able to use heavy duty curtains.

Furthermore, the track can be bent or curved increasing the possibilities of this top-selling product, already an excellent option due to its price, versatility and resistance.

The 5 exclusive motorized track systems are presented in different engine powers, multiple choices for home automation application, and even several charging sources such as the traditional electric supply or the solar power (more in line with the renewable sources and current ecologic needs).

 Le rail motorisé est un système pour coulisser des rideaux à l'aide d'une télécommande ou d'un interrupteur mural. Compatibles avec des systèmes de Domotique. Les multiples options que nous proposons couvrent tous les besoins de décoration intérieure, en plus des bureaux ou même des théâtres, comme nous l'avons déjà fait avec l'automatisation des toiles. La qualité du rail RM09 et les systèmes motorisés permettent à l'installateur ou aux décorateurs d'utiliser des rideaux pour travaux lourds.

En outre, le rail peut être plié ou courbé augmentant les possibilités de ce produit numéro 1 des ventes, déjà une excellente option en raison de son prix, sa polyvalence et sa résistance. Les 5 systèmes motorisés exclusifs sont présentés dans différentes puissances de moteur, choix multiples pour l'application de domotique, et même plusieurs sources de charge telles que l'alimentation électrique traditionnelle ou l'énergie solaire (plus conforme aux sources renouvelables et aux besoins écologiques actuels).

RM09-43 Batería

Características / Features / Caractéristiques	Opciones / Options / Options	Radio / Radius / Rayon	2 m	4 m	6 m	8 m	12 m
		0°	40 Kg	30 Kg	25 Kg	20 Kg	-
		90°	30 Kg	25 Kg	20 Kg	10 Kg	-
		R≥200 cm	30 Kg	25 Kg	20 Kg	10 Kg	-
		90° x 2	-	-	-	-	-

RM09-46

Características / Features / Caractéristiques	Opciones / Options / Options	Radio / Radius / Rayon	2 m	4 m	6 m	8 m	12 m
		0°	50 Kg	40 Kg	35 Kg	25 Kg	15 Kg
		90°	35 Kg	30 Kg	20 Kg	15 Kg	-
		R≥200 cm	30 Kg	30 Kg	20 Kg	15 Kg	-
		90° x 2	25 Kg	20 Kg	10 Kg	-	-

RM09-TA

Características / Features / Caractéristiques	Opciones / Options / Options	Radio / Radius / Rayon	2 m	4 m	6 m	8 m	12 m
		0°	60 Kg	50 Kg	40 Kg	30 Kg	20 Kg
		90°	50 Kg	40 Kg	30 Kg	20 Kg	-
		R≥200 cm	50 Kg	40 Kg	30 Kg	20 Kg	-
		90° x 2	30 Kg	20 Kg	10 Kg	-	-

RM09-92

Características / Features / Caractéristiques	Opciones / Options / Options	Radio / Radius / Rayon	2 m	4 m	6 m	8 m	12 m
		0°	60 Kg	50 Kg	55 Kg	35 Kg	20 Kg
		90°	50 Kg	40 Kg	30 Kg	10 Kg	-
		R≥200 cm	50 Kg	40 Kg	30 Kg	10 Kg	-
		90° x 2	40 Kg	30 Kg	20 Kg	-	-

RM09-95 conectado por cable eléctrico / Electric cable wired system / Système raccordé à fil électrique

Características / Features / Caractéristiques	Opciones / Options / Options	Radio / Radius / Rayon	2 m	4 m	6 m	8 m	12 m
		0°	60 Kg	50 Kg	55 Kg	35 Kg	20 Kg
		90°	50 Kg	40 Kg	30 Kg	10 Kg	-
		R≥200 cm	50 Kg	40 Kg	30 Kg	10 Kg	-
		90° x 2	40 Kg	30 Kg	20 Kg	-	-

RM09-95 conectado por cable telefónico / Telephone cable wired system / Système raccordé à fil téléphonique

Características / Features / Caractéristiques	Opciones / Options / Options	Radio / Radius / Rayon	2 m	4 m	6 m	8 m	12 m
		0°	100 Kg	90 Kg	80 Kg	60 Kg	40 Kg
		90°	80 Kg	70 Kg	60 Kg	50 Kg	30 Kg
		R≥200 cm	80 Kg	70 Kg	60 Kg	50 Kg	30 Kg
		90° x 2	60 Kg	50 Kg	40 Kg	10 Kg	-

Tablas de Pesos y Curvas / Weight and curve options table / Tableau de poids et de courbures

RM09-93		Radio / Radius / Rayon	2 m	4 m	6 m	8 m	12 m
	Opciones / Options / Options	0°	120 Kg	100 Kg	90 Kg	70 Kg	50 Kg
		90°	80 Kg	70 Kg	60 Kg	55 Kg	40 Kg
		R≥200 cm	80 Kg	750 Kg	60 Kg	55 Kg	40 Kg
		90° x 2	60 Kg	50 Kg	40 Kg	20 Kg	10 Kg

NEW

RM09-1000 Plano Inclinado / Inclined Plain / Plan Incliné		Radio / Radius / Rayon	2 m	4 m	6 m	8 m	12 m	
	Opciones / Options / Options	0°	70 Kg	60 Kg	50 Kg	40 Kg	20 Kg	
		90°	60 Kg	50 Kg	40 Kg	30 Kg	10 Kg	
		R≥200 cm	60 Kg	50 Kg	40 Kg	30 Kg	10 Kg	
		90° x 2	45 Kg	35 Kg	30 Kg	10 Kg	-	
Inclinado / Inclined / Incliné		Radio / Radius / Rayon	Hasta 6 m / Up to 6 m / Jusqu'à 6 m					
		20°				20 kg		
		30°				10 kg		
		40°				5 kg		

NEW

Descripción Leyendas / Caption description / Description de la légende

Mando a distancia Remote Control. Télécommande.	Toque Automático Touch Control. Contrôle tactile.	Manipulación sin corriente eléctrica Manipulation w/o electricity supply. Application sans alimentation électrique.	Nº de ciclos Number of cycles. Nombre de cycles.	Batería recargable con energía solar Solar-charged Battery. Batterie rechargeable par l'énergie solaire.	Motor Mecánico Mechanical Limit. Limites Mécaniques.	Domotización por cable telefónico Automation through phone cable. Domotique via câble téléphonique.	Domotización por cable eléctrico Automation through electrical cable connection. Domotique via câble électrique.

Especificaciones técnicas / Technical characteristics / Caractéristiques techniques

Modelo Model / Modele	Voltaje Rated Voltage / Tension nominale	Frecuencia Rated Frequency / Fréquence nominale	Intensidad Rated Current / Courant nominale	Potencia Rated Torque / Couple nominal	RPM Rated Speed / Vitesse nominale	Velocidad Speed / Vitesse	Tiempo de funcionamiento Running Time / Temps de course	Protección IP Grade / Protection
RM09-43 Bat	12,6 VCD	DC	1,50 A	0,8 NM	100	0,13 m/s	S3 50%	IP41
RM09-46	100-240 VAC	50/60 Hz	0,40 A -1,2 A	1 NM	118	0,17 m/s	S3 50%	IP42
RM09-TA	100-240 VAC	50/60 Hz	0,35 A -1,5 A	1,2 NM	85-76	0,11 m/s	S3 50%	IP41
RM09-92	100-240 VAC	50/60 Hz	0,35 A -1,5 A	1 NM	95	0,13 m/s	S3 50%	IP41
RM09-93	100-240 VAC	50/60 Hz	0,45 A	2 NM	80	0,11 m/s	S3 50%	IP41
RM09-95 (Elec.)	100-240 VAC	50/60 Hz	0,35 A -1,5 A	1 NM	104-100	0,14 m/s	S3 50%	IP41
RM09-95 (Tel.)	100-240 VAC	50/60 Hz	0,45 A -1,5 A	1,5-2,0 NM	86-70	0,12 m/s	S3 50%	IP41
RM09-1000	220-240 VAC	50/60 Hz	0,27 A	1,2 NM	88,6-106,3	0,15 m/s	S3 30%	IP41

RM09-43		RM09-46		RM09-TA		RM09-92		NEW RM09-93		RM09-95		NEW RM09-1000				
REF		REF		REF		REF		REF		REF		REF				
J.B1500	556,22 €	J.P1500	308,42 €	J.R1500	509,94 €	J.D1500	463,92 €	J.T1500	559,22 €	J.S1500	592,12 €	J.I1500	426,34 €	3	16	150
J.B2000	586,96 €	J.P2000	339,76 €	J.R2000	539,52 €	J.D2000	494,62 €	J.T2000	589,08 €	J.S2000	623,68 €	J.I2000	457,10 €	3	20	200
J.B2500	621,02 €	J.P2500	375,08 €	J.R2500	567,26 €	J.D2500	528,74 €	J.T2500	622,14 €	J.S2500	654,44 €	J.I2500	491,16 €	4	26	250
J.B3000	651,78 €	J.P3000	406,44 €	J.R3000	596,86 €	J.D3000	558,96 €	J.T3000	652,02 €	J.S3000	684,76 €	J.I3000	521,92 €	4	30	300
J.B3500	685,84 €	J.P3500	441,76 €	J.R3500	624,58 €	J.D3500	593,54 €	J.T3500	685,08 €	J.S3500	715,32 €	J.I3500	555,96 €	5	36	350
J.B4000	718,70 €	J.P4000	475,72 €	J.R4000	654,16 €	J.D4000	626,42 €	J.T4000	716,98 €	J.S4000	746,70 €	J.I4000	588,84 €	6	40	400
J.B4500	752,76 €	J.P4500	511,02 €	J.R4500	681,90 €	J.D4500	660,46 €	J.T4500	750,04 €	J.S4500	777,28 €	J.I4500	622,90 €	7	46	450
J.B5000	783,52 €	J.P5000	542,38 €	J.R5000	711,52 €	J.D5000	691,22 €	J.T5000	779,90 €	J.S5000	808,66 €	J.I5000	653,64 €	7	50	500
J.B5500	817,56 €	J.P5500	577,70 €	J.R5500	738,82 €	J.D5500	725,28 €	J.T5500	812,98 €	J.S5500	839,24 €	J.I5500	687,70 €	8	56	550
J.B6000*	857,22 €	J.P6000*	617,78 €	J.R6000*	776,68 €	J.D6000*	764,92 €	J.T6000*	851,48 €	J.S6000*	884,28 €	J.I6000*	727,36 €	8	60	600*
J.B6500*	891,26 €	J.P6500*	653,12 €	J.R6500*	804,96 €	J.D6500*	798,98 €	J.T6500*	884,56 €	J.S6500*	908,68 €	J.I6500*	761,40 €	9	66	650*
J.B7000*	924,14 €	J.P7000*	687,06 €	J.R7000*	834,02 €	J.D7000*	831,86 €	J.T7000*	916,44 €	J.S7000*	940,06 €	J.I7000*	794,28 €	10	70	700*
J.B7500*	958,20 €	J.P7500*	722,38 €	J.R7500*	861,74 €	J.D7500*	865,92 €	J.T7500*	949,50 €	J.S7500*	970,62 €	J.I7500*	828,34 €	11	76	750*
J.B8000*	988,96 €	J.P8000*	753,74 €	J.R8000*	891,34 €	J.D8000*	896,66 €	J.T8000*	979,38 €	J.S8000*	1.002,00 €	J.I8000*	859,10 €	11	80	800*
J.B8500*	1.023,02 €	J.P8500*	789,06 €	J.R8500*	917,60 €	J.D8500*	930,72 €	J.T8500*	1.012,44 €	J.S8500*	1.032,56 €	J.I8500*	893,14 €	12	86	850*
J.B9000*	1.055,88 €	J.P9000*	823,00 €	J.R9000*	927,04 €	J.D9000*	963,60 €	J.T9000*	1.044,34 €	J.S9000*	1.063,94 €	J.I9000*	926,02 €	13	90	900*
J.B9500*	1.087,84 €	J.P9500*	855,74 €	J.R9500*	976,38 €	J.D9500*	995,54 €	J.T9500*	1.075,36 €	J.S9500*	1.094,52 €	J.I9500*	957,98 €	13	96	950*
J.B10000*	1.120,70 €	J.P10000*	945,12 €	J.R10000*	1.000,52 €	J.D10000*	1.026,04 €	J.T10000*	1.104,96 €	J.S10000*	1.125,90 €	J.I10000*	990,82 €	14	100	1000*

Conjuntos completos con soporte a techo (J.R107)
Complete sets with ceiling bracket (J.R107) /
Kits complets avec support plafond (J.R107)

* Se suministran empalmados a partir de 600 mm.
Supplied in 2 halves from 600 mm. /
Fourni en 2 parties a partir 600 mm.

- Disponible también para Sistema con ONDA PERFECTA empleando las referencias D.115 Corredera con Cordón de paso 60 mm y D.116 Corredera con Cordón con paso 80 mm. (Ref: J.115I ó J.116I = 12,78 € PVP).

- Disponible también para Sistema con CINTA ACORDEÓN empleando las referencias D.111 Cinta con Automáticos y D.112 Corredera con Cordón. (Ref: J.ROP = 7,20 € PVP)

- Also available with PERFECT WAVE SYSTEM, ref. D.115 Corded Glider space 60 mm and D.116 Corded Glider space 80 mm. (Ref: J.115I or J.116I = 12,78 € SRP).

- Available also for the RUFFLE TAPE SYSTEM by using references D.111 ruffle tape and D.112 corded runner (Ref :J.ROP = 7,20 € SRP)

- Aussi disponible avec le SYSTÈME D'ONDE PARFAITE, ref. D.115 Glisseur en Cordon pas 60 mm et D.116 Glisseur en Cordon pas 80 mm. (Ref: J.115I et J.116I = 12,78 € PVP).

- Disponible aussi avec l'option de RUBAN ACCORDÉON avec les références D.111 ruban accordéon et D.112 glisseur en cordon (Ref: J.ROP = 7,20 € PVP)

Características Generales RM09 / RM09 Main features / RM09 caractéristiques principales

 El **Riel RM09** es un sistema de riel eléctrico de última generación apto tanto para uso doméstico, comercial o industrial debido a sus altas prestaciones. El perfil es de aluminio lacado blanco. Este perfil se puede montar empleando 6 motores de diferentes potencias y características que están explicadas en la tabla.

Características Generales:

- Disponen de un Mando a Distancia de 7 canales y pulsador de pared de 2 canales (según modelo). El mando a distancia tiene un alcance de 30 metros. La programación del sistema es muy fácil y rápida.
- Funcionamiento sin corriente eléctrica, en el caso de cortes de luz o corriente eléctrica la cortina se puede accionar manualmente.
- El motor está preparado para incorporarlo a un sistema domótico de forma fácil.
- El riel se sirve cortado a medida y preparado para el modo de apertura deseado: apertura izquierda, apertura derecha o apertura central. El motor se puede colocar a la izquierda o a la derecha del riel según se desee.
- El motor es muy silencioso y las correderas con ruedas permiten un deslizamiento suave y fluido de la cortina.
- Su largo máximo es de 12 metros mediante empalme.
- Permite 2 posiciones intermedias programables.
- El Receptor está integrado en el motor.
- El Final de Carrera es electrónico.
- Memoria de programación en ausencia de energía eléctrica.
- Dispositivo térmico de protección contra sobrecargas eléctricas.
- Parada automática del sistema al finalizar su recorrido.
- Motor asincrónico, libre de interferencias.
- Funciona por correa dentada y soporta hasta 80 kg de peso (según modelo) de cortina según las medidas indicadas en la tabla.

Altran ofrece una **Garantía de 2 años** para todos sus Motores, a partir de la fecha de factura, salvo mal uso o rotura por parte del cliente-usuario-instalador.

 **RM09** is a high-tech electric motorized track system suitable for domestic and commercial or industrial installation. The track profile is made of white anodized aluminium. **This system can function with 6 motors of different powers and features indicated in the data table.**

It is operated with a 7-channel remote control and/or 2-channel wall switch. The remote has a range of 30 meters. Programming the system is very easy and fast. The system includes a "touch-control" mode that allows the curtain to be opened or closed without controls by simply pulling gently on the fabric. This function can be cancelled whenever desired. The curtains can be drawn manually when there is power failure. The motor can be connected to home automation easily. The track is supplied cut-to-measure and assembled to the opening mode specified by the customer: left-side opening, right-side opening or central opening. The motor can be easily installed on the left side or the right side of the track. The motor is extremely quiet and the wheeled runners glide smoothly and noiselessly along the track - Slow start and slow stop with two intermediate functions. Built-in radio receiver. Full automatic setting of the limits. Program memory when power failure. Overvoltage protection thermal device. Automatic slow stop at run end. Interference free, asynchronous motor. Transmission by driving belt, depending on the motor model, the system can stand up to 80 kg s-curains following table data. The maximum length of the track is 12 meters using a splice or joiner.

Altran offers a 2 year **warranty** for all motors, from the date of invoice, unless misuse or failure by the customer-user-installer.

 Le rail **RM09** est un système high-tech destiné à l'usage de particuliers comme pour des installations commerciales ou industrielles grâce à ses grandes prestations. Le rail est fabriqué à partir d'aluminium laqué blanc. **Ce système peut fonctionner avec 6 moteurs de différentes puissances et caractéristiques indiquées dans le tableau technique.**

Il est équipé d'une télécommande de 7 canaux et d'un interrupteur mural de 2 canaux. La télécommande a une portée de 30 mètres. La programmation du système est très simple et rapide. Ce système comprend la fonction de "touche automatique" qui permet d'ouvrir ou fermer le rideau sans commande, en tirant légèrement sur le rideau avec la main. Cette fonction peut être enlevée en cas de besoin. Fonctionnement sans courant électrique. En cas de coupure de courant, le rideau peut être actionné manuellement. Il est possible d'adapter un système de domotique avec ce moteur. Le rail est fourni coupé sur mesure avec le mode d'ouverture sollicité: vers la gauche, vers la droite ou centrale. Le moteur peut être placé à droite ou à gauche sur le rail. Le moteur est très silencieux et les glisseurs permettent un glissement léger et fluide du rideau. Le largeur maximum est de 12 mètres avec raccords. Début et fin de course lents avec 2 fonctions d'arrêt intermédiaires. Récepteur radio intégré. Réglage automatique du début et fin de course. Mémoire de programme en cas de panne de tension. Dispositif thermique de protection de surtension. Arrêt lente automatique fin de course. Moteur asynchrone, exempt d'interférences. Transmission par courroie dentée, selon le modèle capable de supporter rideaux jusqu'à 80 kgs., voir tableau technique.

Altran offre une **garantie** de 2 ans pour tous les moteurs, à partir de la date de la facture, sauf utilisation incorrecte ou rupture de la part du client-utilisateur-installateur.

Observación sobre Curvatura del Riel / Remark on Track Bending / Observation Cintrage du Rail

 Curvatura RM09.

J.RC - curvatura por Ángulo - 86,52 €PVP
J.RA - curvatura por Arco - 129,78 €PVP
El Coste incluye el curvado, el empaquetado y el sobrecosto en el envío con respecto a un envío normal dentro de territorio peninsular español.
Radio mínimo de curvatura: 35cm

 BENDING RM09.

J.RC - bending in angle - 86,52 €SRP
J.RA - bending in Arc - 129,78 €SRP
The price includes the bending and the special packaging. The freight charges due to the special sizes will be charged by separate in the cases of shipments outside the Spanish mainland.
Minimum bending radius: 35cm

 CINTRAGE RM09.

J.RC - cintrage par angle - 86,52 €PVP
J.RA - cintrage par Arc - 129,78 €PVP
Le prix inclue le cintrage et l'emballage à cette fin. Les frais de transport par les dimensions enregistrées seront facturés séparément dans les éditions pour les envois non péninsulaires.
Radius minimum de cintrage: 35cm

 - En casos en los que haya 2 o más Curvas en forma de Arco o Ángulo con idéntico o diferente radio en el mismo riel, se servirá empleando empalmes para asegurar el deslizamiento correcto de las correderas por la zona de unión de los arcos. Cada arco se cobrará por separado al precio de 129,78 €PVP.

- El cliente debe proporcionar SIEMPRE una plantilla con el arco y radio de la curvatura.

En el caso de que el cliente no la aporte y tengamos que crearla en Altran, el importe será de 31,50 € PVP.

 - In the case of 2 or more curvings in arch or angle, with radius same size of different in the same track, we will supply the track with joints in order to assure the correct slide of the runners in the area of union. Every arch will be invoice by separate, price 129,78 €SRP.

- Client should **provide** the physical template with the arch and the radius of the bending.

Altran offers the possibility of create the template price 31,50 € SPR.

 - Dans le cas de 2 ou plus curves en forme d'arc ou angle, avec rayon identique ou différent dans le même rail, on fournira le rail avec raccords pour sécuriser le glissement correct des glisseurs dans la zone de jonction des arcs. Chacun des arcs sera facturé séparément à un prix de 129,78 €PVP.

- Le client **toujours** doit fournir le modèle en papier avec l'arc et rayon du cintrage.

Altran offre la possibilité de créer le modèle en papier à un prix de 31,50 € PVP.

Accesorios / Accessories / Accessoires

Motor RM09-1000

Motor RM09-1000 /
Moteur RM09-1000

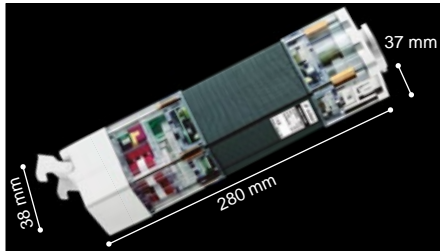

REF	Ø	U	€	€	cm
J.R94		1		270,92 €	

NEW

* Si se quiere emplear con mando a distancia es necesario emplear el RECEPTOR WIRELESS 2 CANALES J.R125 / When controlled with remote device, it is necessary the use of the WIRELESS 2-CHANNELS RECEIVER ref. J.R125 / En cas d'usage avec télécommande, il faut utiliser le RÉCEPTEUR 2 CANAUX WIRELESS ref. J.R125

Motor RM09-43
Batería

Motor RM09-43
battery /
Moteur RM09-43
batterie

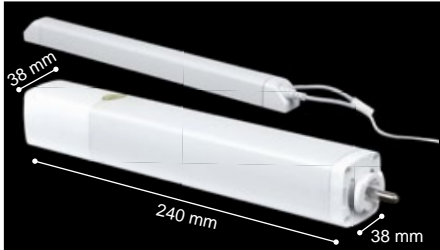

REF	Ø	U	€	€	cm
J.R96		1		335,78 €	

Motor RM09-46

Motor RM09-46 /
Moteur RM09-46

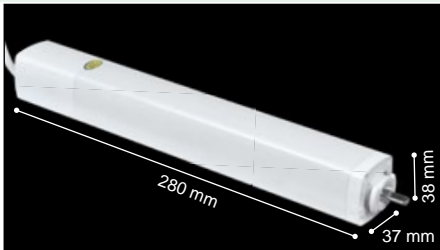

REF	Ø	U	€	€	cm
J.R97		1		154,50 €	

Motor RM09-TA

Motor RM09-TA /
Moteur RM09-TA

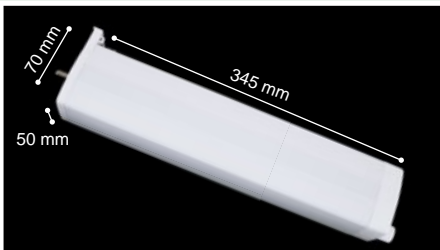

REF	Ø	U	€	€	cm
J.R100		1		335,78 €	

* Para domotizar el sistema RM09, con o sin el pulsador J.R112, es necesario emplear el cable telefónico con conector RJ9 (no incluido). / For home automation purposes of the RM09 system, with or without the wall switch J.R112, it is necessary to use the telephone cable with plug RJ9 (not included). / Pour domotiser le système RM09, l'utilisation du câble téléphonique avec connecteur RJ9 est nécessaire (ne pas inclus).

Motor RM09-93

Motor RM09-93 /
Moteur RM09-93

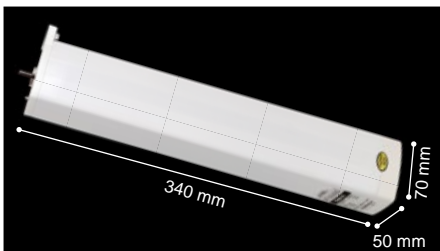

REF	Ø	U	€	€	cm
J.R93		1		415,00 €	

NEW

Motor RM09-92

Motor RM09-92 /
Moteur RM09-92

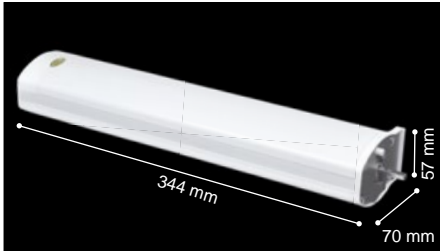

REF	Ø	U	€	€	cm
J.R95		1		276,86 €	

Motor RM09-95

Motor RM09-95 /
Moteur RM09-95



REF	Ø	U	€	€	cm
J.R99		1		427,44 €	

* Para domotizar el sistema RM09, con o sin el pulsador J.R112, es necesario emplear el cable telefónico con conector RJ9 (no incluido). / For home automation purposes of the RM09 system, with or without the wall switch J.R112, it is necessary to use the telephone cable with plug RJ9 (not included). / Pour domotiser le système RM09, l'utilisation du câble téléphonique avec connecteur RJ9 est nécessaire (ne pas inclus).

Mando a
Distancia

Remote Control /
Télécommande



REF	Ø	U	€	€	cm
J.R113		1		53,28 €	

Accesorios / Accessories / Accessoires

Soporte pared mando a distancia

Wall holder for remote control / Support mural pour télécommande

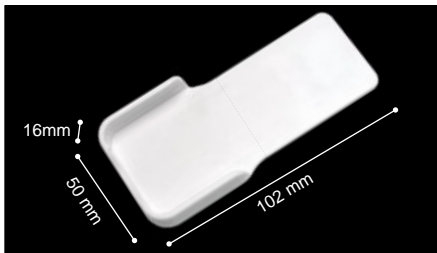

REF	Ø	U	€	1	cm	NEW
J.R115		1		3,00 €		

Pulsador Doble /

Double Motor Wall Switch / Interrupteur Double

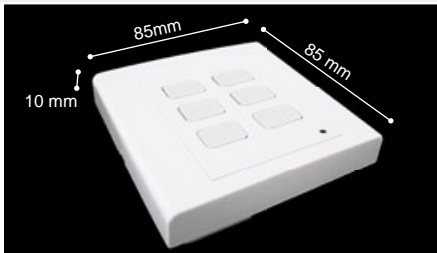

REF	Ø	U	€	1	cm	NEW
J.R112		1		31,92 €		

* Se sirve con caja de plástico para instalar el soporte empotrado en la pared. / Supplied with plastic box to insert the bracket into the wall. / Fourni avec boîte en plastic pour insérer le support au mur.

Receptor Pulsador 2 canales RM09-1000 /

Wireless 2-Channels receiver / Récepteur 2 canaux wireless



REF	Ø	U	€	1	cm	NEW
J.R125		1		108,14 €		

* Se sirve con caja de plástico para instalar el soporte empotrado en la pared. / Supplied with plastic box to insert the bracket into the wall. / Fourni avec boîte en plastic pour insérer le support au mur.

Caja para empotrar Receptor Pulsador /

Insert box for wall switch/receiver / Boîte d'encart interrupteur/Récepteur

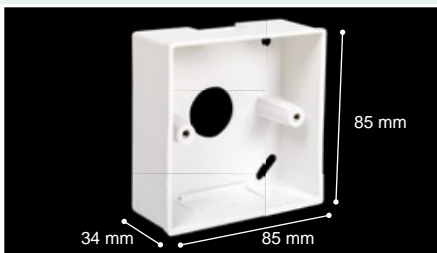

REF	Ø	U	€	1	cm	NEW
J.R126		1		3,58 €		

Pulsador a distancia 2 canales /

Wireless wall switch 2-Channels / Récepteur mur sans fil 2 canaux

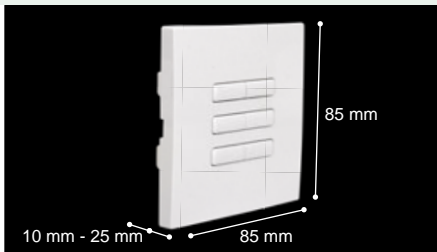

REF	Ø	U	€	1	cm	NEW
J.R127		1		86,52 €		

* Se sirve con caja de plástico para instalar el soporte empotrado en la pared. / Supplied with plastic box to insert the bracket into the wall. / Fourni avec boîte en plastic pour insérer le support au mur.

Perfil RM09

Track RM09 / Rail RM09

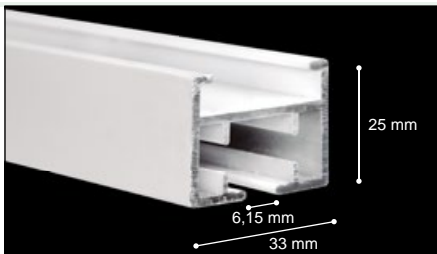

REF	Ø	U	€	1	cm	NEW
J.R101		1		20,40 €/m	600	

Canterera Motor RM09-TA y RM09-93

End Pulley Motor RM09-TA & RM09-43 / Bouchons Finaux Motor RM09-TA et RM09-43



REF	Ø	U	€	1	cm	NEW
J.R102		1		16,26 €		

Canterera Motor RM09-92 y RM09-95

End Pulley Motor RM09-92 & RM09-95 / Bouchons Finaux Motor RM09-92 et RM09-95

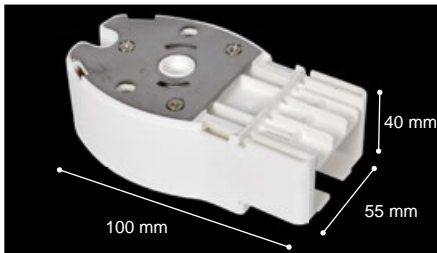

REF	Ø	U	€	1	cm	NEW
J.R120		1		18,22 €		

Accesorios / Accessories / Accessoires

Cantonera Motor
RM09-43 y RM09-46

End Pulley
Motor
RM09-43 & RM09-46 /
Bouchons Finaux
Motor
RM09-43 et RM09-46

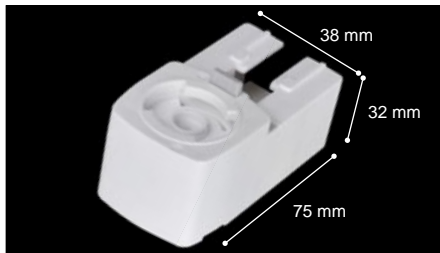

REF	Ø	U	€	€	cm
J.R122		1		9,06 €	

Cantonera Motor
RM09-1000

End Pulley
Motor RM09-1000 /
Bouchons Finaux
Motor RM09-1000

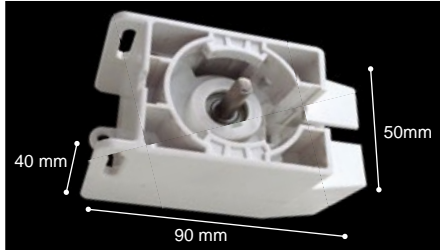

REF	Ø	U	€	€	cm
J.R123		1		14,74 €	

NEW

Cantonera Simple
RM09-1000

End Pulley
Motor RM09-1000 /
Bouchons Finaux
Motor RM09-1000

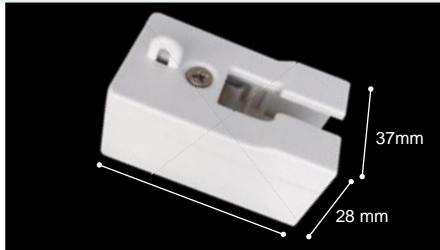

REF	Ø	U	€	€	cm
J.R124		1		9,06 €	

NEW

Soporte Techo
Ek rafuerte

Ceiling Bracket
(Extrastrong) /
Support Plafond
Ek rafort



REF	Ø	U	€	€	cm
J.R108		1		2,92 €	

Soporte Techo
Giratorio

Round Ceiling
Bracket /
Support Plafond

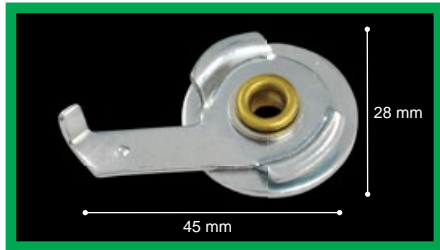

REF	Ø	U	€	€	cm
J.R107		1		1,84 €	

* Soporte incluido en el kit / Bracket supplied in the kit / Support fourni dans le kit.

Bloqueo
Cantonera

End-Pulley Stop /
Frein Rail



REF	Ø	U	€	€	cm
J.R104		1		1,22 €	

Gancho Fijo
Cantonera

Static Hook
End-Pulley /
Crochet Fixe



REF	Ø	U	€	€	cm
J.R110		1		0,26 €	

Corredera Maestra

Master Carrier /
Porter principal ou
croisement



REF	Ø	U	€	€	cm
J.R105		1		10,10 €	

Accesorios / Accessories / Accessoires

Corredera Maestra
RM09 para
rieles curvados

Master carrier for
RM09 curved rails /
Coulisse maîtresse
RM09 rails cintrés



REF	∅	U	€	€	cm
J.R114		1		13,08 €	

NEW

Corredera
Runner /
Glisseur



REF	∅	U	€	€	cm
J.R106		1		0,514 €	

Corredera con Cordón
de paso 60 mm
con ruedas
y onda perfecta
Cordé wheelé wæ
runner 60 mm /
Glisseur cordon æ c
roue pour onde
parfaite pas 60 mm

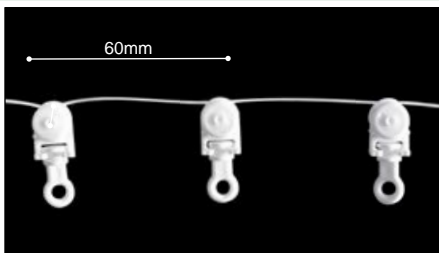

REF	∅	U	€	€	cm
D.115		1		17,64 €/m	

Corredera con Cordón
de paso 80 mm
con ruedas
y onda perfecta
Cordé wheelé wæ
runner 80 mm /
Glisseur cordon æ c
roue pour onde
parfaite pas 80 mm

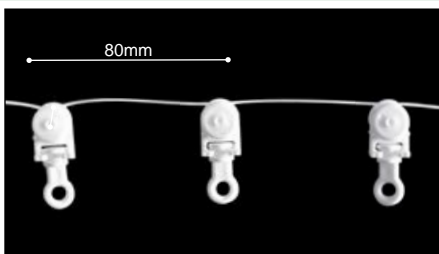

REF	∅	U	€	€	cm
D.116		1		17,64 €/m	

Corredera recomendada para los sistemas motorizados por su resultado estético /
Recommended runner option for the motorized system for aesthetic reasons /
Option de glisseur recommandée pour les systèmes motorisés pour son résultat esthétique.

Empalme
Splice /
Raccordeur



REF	∅	U	€	€	cm
J.R109		1		6,84 €	

Correa Dentada
Drive Belt /
Courroie Dentée

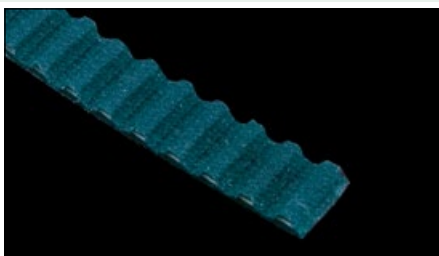

REF	∅	U	€	€	cm
J.R103		1		18,74 €	

Soporte Múltiple de
Pared Ek rafuerte

Wall Ek ension
Bracket (Extrastrong) /
Support Mural
Ek rafort



REF	∅	U	€	€	cm
D.3001BL		25	3,46 €	3,98 €	7
D.3002BL		25	4,16 €	4,78 €	11
D.3003BL		25	4,94 €	5,68 €	15
D.3004BL		25	5,18 €	5,96 €	19
D.3005BL		25	5,38 €	6,19 €	23

 **ALTRAN**[®]
SISTEMAS PARA DECORAR CORTINAS

RM09



Sistemas motorizados Altran, capaces de alcanzar los 120 Km/h
¡Perdón! De arrastrar hasta 120 Kg

 **ALTRAN**[®]
SISTEMAS PARA DECORAR CORTINAS

Estores

roman blinds / stores bateaux



 **ALTRAN**[®]
SISTEMAS PARA DECORAR CORTINAS



ALTRAN[®]

CURTAIN DECORATION SYSTEMS

Estor Oculto (Manual) / NOT Visible Roman Blind (Manual) / Stores Bateaux NON Visible (Manuel)



EASY COMPACT Estor Oculto NOT Visible Roman Blind / Stores Bateaux NON Visible	REF	Freno Lock Frein	Soportes Brackets Supports	Guía Cordón Cord Guide Guides Cordón	U	€	€	cm
No incluye varillas/ Laths not included/ Sans jonc	D.14075	1:1	2	2	6	29,68 €	34,13 €	75
	D.14100	1:1	2	2	6	33,80 €	38,87 €	100
	D.14125	1:1	3	3	6	42,68 €	49,08 €	125
	D.14150	1:1	3	3	6	46,78 €	53,80 €	150
	D.14175	1:1	3	3	6	50,90 €	58,54 €	175
	D.14200	1:1	4	4	6	59,34 €	68,24 €	200
	D.14250	1:4	5	5	6	72,96 €	83,90 €	250
	D.14300	1:4	5	6	6	88,18 €	101,41 €	300
	D.14350	1:4	6	7	6	98,94 €	113,78 €	350
	D.14400	1:4	6	8	8	111,94 €	128,73 €	400

- El conjunto completo consiste en:
- Perfil velcroado.
 - Mecanismo integrado: (Guía-hilos, freno, cadeneta 3m., varilla y tapa).
 - Soportes ref. D.1015 (se puede cambiar por D.1023, solicitándolo en el pedido).
 - Pletina contrapeso ref: C.12003BL.
 - Cordón 4 m.
 - Freno 1:1 hasta 4 kg .
 - Freno 1:3 hasta 9 kg .

- Complete set consists of:
- Velcro-bonded profile.
 - Integrated mechanism: (Cord Guides, 3m chainlock, shaft, endcap).
 - Brackets ref. D.1015 (Supplied also with bracket D.1023 upon request).
 - Batten ref: C.12003BL.
 - Cord 4 m.
 - Lock 1:1 Up to 4 kg .
 - Lock 1:3 Up to 9 kg .

- Le kit complet est composé de:
- Rail velcro.
 - Le système intégré: (Guide Cordón, frein, chaîne 3m). (Guide Cordón, frein, chaîne 3m).
 - Supports ref. D.1015 (Fourni avec le support D.1023 sur demande).
 - Barre de lestage ref: C.12003BL.
 - Corde 4 m.
 - Frein 1:1 Jusqu'à 4 kg.
 - Frein 1:3 Jusqu'à 9 kg.

Accesorios / Accessories / Accessoires

Riel Velcroado
Aluminium Track with Velcro / Rail Aluminium avec Velcro

REF	Ø	U	€	€	cm
D.1010		60	10,72 €	12,33 €	600

Freno 1:1 (sin cadena)
Chain Locking Mechanism 1:1 (without chain) / Frein chainette 1:1 (sans chainette)

REF	Ø	U	€	€	cm
D.1043		25	4,80 €	5,52 €	

Freno 1:4 (sin cadena)
Chain Locking Mechanism 1:4 (without chain) / Frein chainette 1:4 (sans chainette)

REF	Ø	U	€	€	cm
D.1044		25	4,80 €	5,52 €	

Accesorios / Accessories / Accessoires

Rodillo Guía-Hilos
4m Cordón
(1,2mm)

Cord Barrel Guide
4m cord (1,2mm) /
Rouleau Guide Fil
4m corde (1,2mm)



REF	∅	U	€	€	cm
D.1042		25	4,34 €	4,99 €	

Rodillo Guía-Hilos
(sin cordón)

Cord Barrel Guide
(without cord) /
Rouleau Guide Fil
(sans cordon)



REF	∅	U	€	€	cm
D.1042S		25	3,14 €	3,61 €	

Soporte

Brack t /
Support



REF	∅	U	€	€	cm
D.1015		50	0,68 €	0,78 €	

* Soporte incluido en el kt / Brack t supplied in the kt / Support fourni dans le kt.

Soporte
con Muelle

Spring Brack t /
Support à Ressort



REF	∅	U	€	€	cm
D.1017		50	0,74 €	0,85 €	

Tapa

Endcap /
Bouchon Final



REF	∅	U	€	€	cm
D.1045		50	0,72 €	0,83 €	

Pletinas
Contrapeso

Battens For
Track Blinds /
Contrepoids Pour
Stores Romain

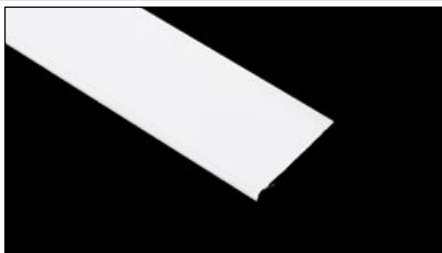

REF	∅	U	€	€	cm
C.12003BL Alum. (202g/m)		60	4,44 €/m	5,11 €/m	600
C.12000 F.Vidrio (180g/m)		60	3,34 €/m	3,84 €/m	600

Pletina
Contrapeso

Battens For Track
Blinds /
Contrepoids pour
Stores Romain
255 mm.



REF	∅	U	€	€	cm
C.12022TR4000 (161grs/m)		40	7,20 €/m	8,28 €/m	400

Varilla de Fibra de
Vidrio (4mm)

Fiberglass Lath /
Jonc Fibre de
Verre pour Stores
Romain
Trans (27x5mm.)



REF	∅	U	€	€	cm
D.4600	4mm	600	0,412 €/m	0,494 €/m	600

Accesorios / Accessories / Accessoires

Varilla de Fibra de Vidrio (3mm)

Fiberglass Lath /
Jonc Fibre de
Verre pour Stores
Romain

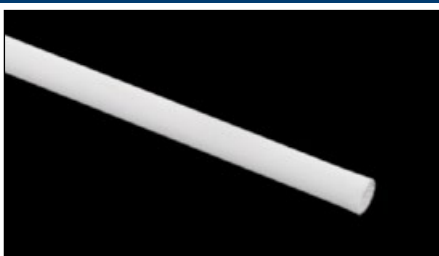

REF	∅	U	€	€	cm
D.3600	3 mm	600	0,35 €/m	0,42 €/m	600

Varilla de Aluminio

Aluminium Shaft /
Jonc Aluminium



REF	∅	U	€	€	cm
C.12018	4 mm	60	2,60 €/m	2,99 €/m	600

Soporte plano

Bracket /
Suport



REF	∅	U	€	€	cm
D.1023		50	1,26 €	1,45 €	

Codo estor EASY COMPACT

Roman Blind Joint
Elwov /
Coude Store
Bateaux



REF	∅	U	€	€	cm
D.1047		10	23,82 €	27,39 €	

Cordón (Bobina) 1,2 mm

Cord (Spool) 1,2 mm /
Corde 1,2 mm



REF	∅	U	€	€	cm
D.09	1,2 mm	500 m	77,16 €		
D.09C	1,2 mm	1000 m	79,42 €		

Rollo Cadeneta

Chain Roll /
Rouleau



REF	∅	U	€	€	cm
D.74		200 m	1,40 €/m	1,68 €/m	
D.74PL		150 m	1,40 €/m	1,68 €/m	

Cadeneta Sin Fin

Continuous Chain /
Chainette



REF	∅	U	€	€	cm
D.70		20	2,48 €	2,98 €	2
D.73		20	3,50 €	4,20 €	3
D.71		20	4,32 €	4,97 €	4
D.73PL		20	4,98 €	5,73 €	3

Empalme Cadeneta

Chain Splice /
Raccord de
Chainette

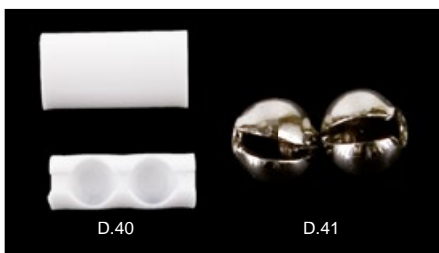

REF	∅	U	€	€	cm
D.40		200	0,206 €	0,247 €	
D.41		500	1,80 €	2,16 €	

Accesorios / Accessories / Accessoires

Contrapeso Mini
(43 g aprox.)

Mini-cordweight /
Mini-contrepois



REF	∅				
I.1110BL		25	1,40 €	1,61 €	
I.1110PL		25	2,12 €	2,44 €	

Contrapeso
(23 g aprox.)

Mini-cordweight /
Mini-contrepois

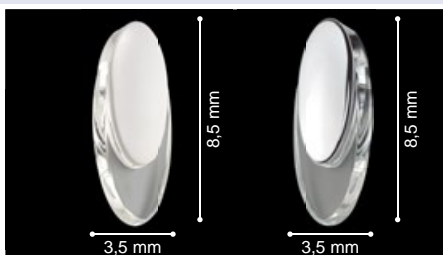

REF	∅				
I.1111BL		25	1,18 €	1,36 €	
I.1111PL		25	2,46 €	2,83 €	

NEW

Anilla de Plástico

Plastic Rings /
Anneau Plastique



REF	∅				
D.32		1000	34,66 €		

Anilla de Plástico
(9x13mm)

Plastic Rings
(9x13mm) /
Anneau Plastique
(9x13mm)



REF	∅				
D.38		1000	37,74 €		

Anilla de Plástico

Plastic Rings /
Anneau Plastique

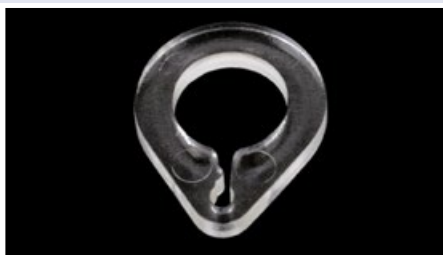

REF	∅				
D.24		1000	34,68 €		

Cinta para Varilla
Estor (16mm)

Roman Blind
LathTape /
Ruban pour Barre
de Store Romain

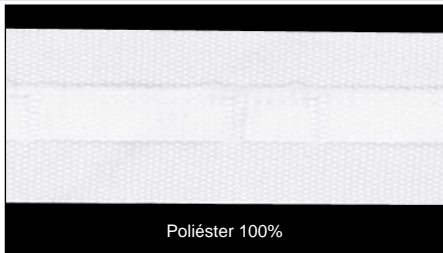

REF	COLOR	rollo (m) roll (m)		RAPPORT	
D.14	blanco/white	300 m	0,31 €/m	-	16 mm
D.14BG	beige	300 m	0,31 €/m	-	16 mm

Cinta Cierre-Velcro
Hembra 20mm.

20 mm Touch&close
fastener Tape
(Loop section) /
Velcro femelle
20mm.

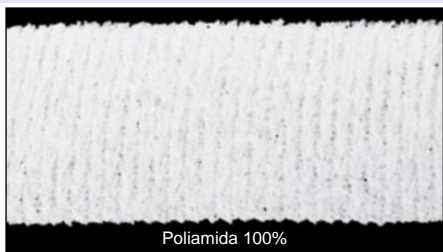

REF	COLOR	rollo (m) roll (m)		RAPPORT	
D.20A (Velour)	blanco/white	50 m	0,60 €/m	-	20 mm
D.5 (Astrakan)	blanco/white	50 m	0,41 €/m	-	20 mm
D.5AD (Astrakan Adhes.)	blanco/white	50 m	0,92 €/m	-	20 mm

Soporte Múltiple
de Pared Blanco

Whit Wall
Extension Bracket /
Support
Mural Blanc



REF	∅				
D.301BL		25	1,98 €	2,38 €	4
D.302BL		25	2,08 €	2,50 €	6
D.303BL		25	2,36 €	2,83 €	10
D.304BL		25	3,00 €	3,60 €	15
D.305BL		25	4,78 €	5,74 €	20

Accesorios / Accessories / Accessoires

Soporte Múltiple de Pared Ek rafluente

Wall Ek ension Bracket (Extrastrong) / Support Mural Ek rafort



REF	∅	U	€	€ ¹	cm
D.3001BL		25	3,46 €	3,98 €	7
D.3002BL		25	4,16 €	4,78 €	11
D.3003BL		25	4,94 €	5,68 €	15
D.3004BL		25	5,18 €	5,96 €	19
D.3005BL		25	5,38 €	6,19 €	23

Protector de Pletina 32 5

Protectie Batten 32 5 / Protecteur de Contrepoids 32 5



REF	∅	U	€	€ ¹	cm
D.311		500	0,21 €	0,25 €	

Muestra estor EASY COMPACT

Demo sample Easy Compact roman blind / Echantillon stores bateaux Easy Compact



REF	∅	U	€	€ ¹	cm
M.313		1		13,56 €	

NEW

STARTRACK

**ESTORES
ROMAN
BLINDS
STORE
BATEAUX**

buenos días
g o o d
m o r n i n g
b o n j o u r

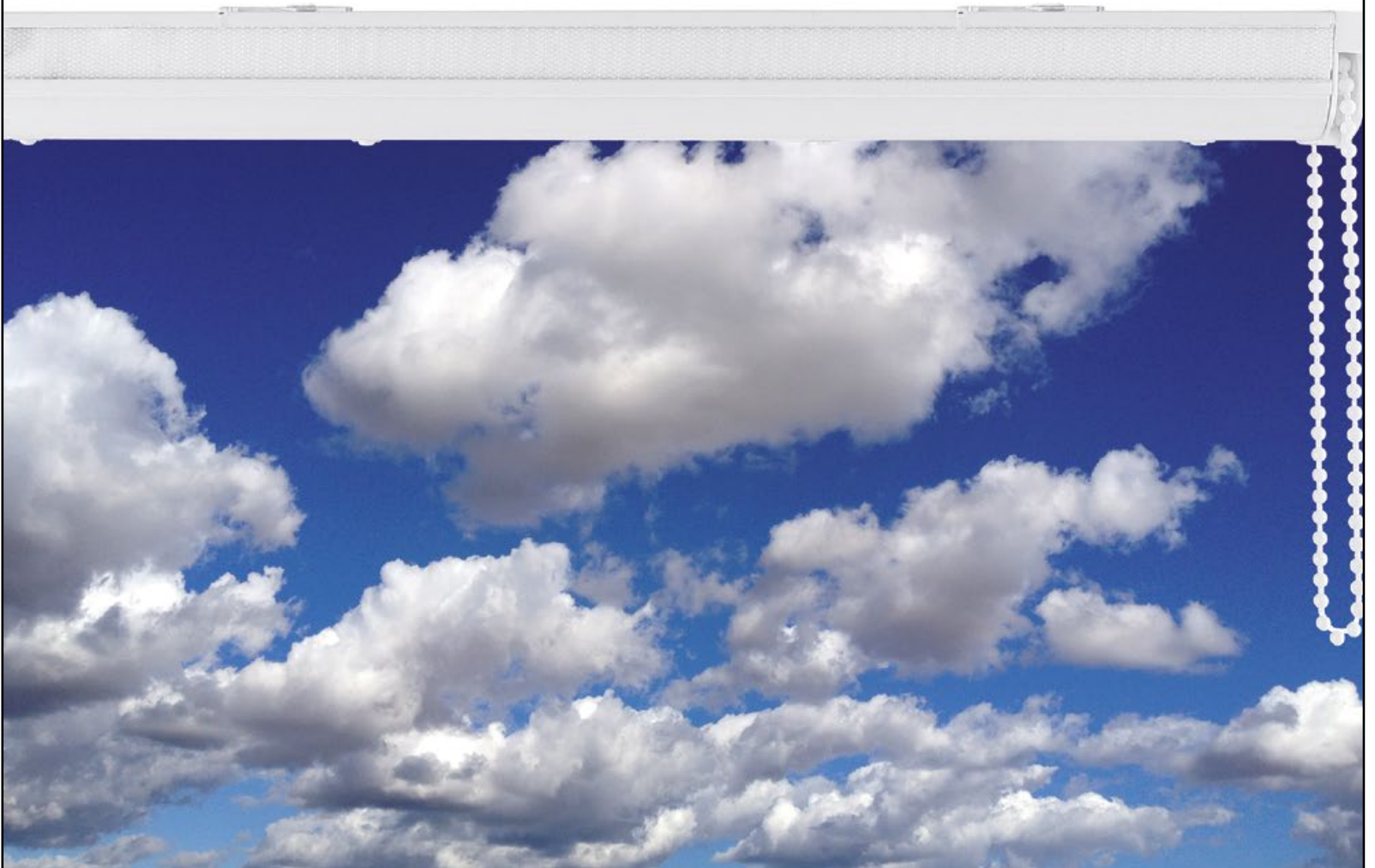

Estor Oculto (Manual) / NOT Visible Roman Blind (Manual) / Stores Bateaux NON Visible (Manuel)

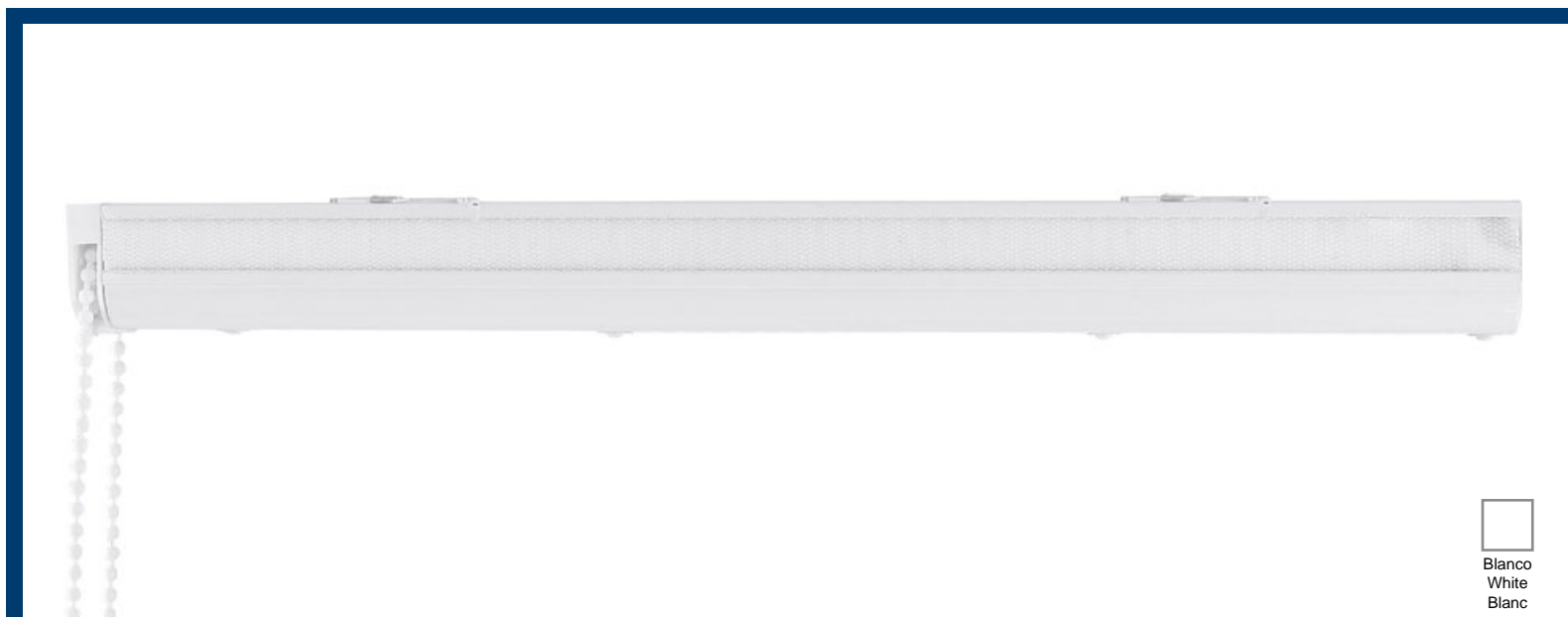

STARTRACK	REF	Freno Lock Frein	Soportes Brackets Supports	Guía Cordón Cord Guide Guides Cordón	U	€	€	cm
Conjuntos Completos Montados / Complete Assembled Sets / Kits Completos Montés	D.11075	1:1	2	2	6	29,68 €	34,13 €	75
	D.11100	1:1	2	2	6	33,80 €	38,87 €	100
	D.11125	1:1	3	3	6	42,68 €	49,08 €	125
	D.11150	1:1	3	3	6	46,78 €	53,80 €	150
	D.11175	1:1	3	3	6	50,90 €	58,54 €	175
	D.11200	1:1	4	4	6	59,34 €	68,24 €	200
	D.11250	1:3	5	5	6	72,96 €	83,90 €	250
	D.11300	1:3	5	6	6	88,18 €	101,41 €	300
	D.11350	1:3	6	7	6	98,94 €	113,78 €	350
	D.11400	1:3	6	8	6	111,94 €	128,73 €	400

* No incluye varillas /
* Laths not included /
* Sans jonc

Información General / General Information / Informations Générales

 Riel de aluminio lacado en blanco con mecanismo integrado y sistema de elevación de cadeneta estores.

Freno 1:1 hasta 4 kg.

Freno 1:3 hasta 9 kg.

El conjunto completo consiste en:

- Perfil velcroado.
- Mecanismo integrado: (Guía-hilos, freno, cadeneta 3m, varilla y tapa).
- Soportes ref. D.1015 (se puede cambiar por D.1023, solicitándolo en el pedido).
- Pletina contrapeso ref: C.12003BL.
- Cordón 4 m.

 White lacquered aluminium track with integrated mechanism and chain operated for roman blinds.

Lock 1:1 Up to 4 kg.

Lock 1:3 Up to 9 kg.

Complete set consists of:

- Velcro-bonded profile.
- Integrated mechanism: (Cord Guides, 3m chainlock, shaft, encap).
- Brackets ref. D.1015 (Supplied also with bracket D.1023 upon request).
- Batten ref: C.12003BL.
- Cord 4 m.

 Rail aluminium blanc laqué avec système mécanique intégré et chaîne pour store Romain.

Freno 1:1 Jusqu'à 4 kg.

Freno 1:3 Jusqu'à 9 kg.

Le kit complet est composé de:

- Rail velcro.
- Le système intégré: (Guide Cordón, frein, chaînette 3m).
- Supports ref. D.1015 (Fourni avec le support D.1023 sur demande).
- Barre de lestage ref: C.12003BL.
- Corde 4 m.

Accesorios / Accessories / Accessoires

Riel Velcroado

Aluminium Track with Velcro / Rail Aluminium avec Velcro

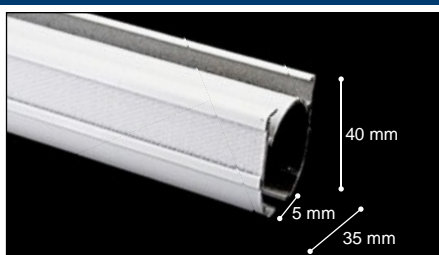

REF	Ø	U	€	€	cm
D.1011		60	10,72 €	12,33 €	600

Accesorios / Accessories / Accessoires

Freno 1:1
(sin cadena)

Chain Lock ng
Mechanism 1:1
(without chain) /
Frein chainette 1:1
(sans chainette)



REF	∅	U	€	€	cm
D.1012		25	4,80 €	5,52 €	

Freno 1:3
(sin cadena)

Chain Lock ng
Mechanism 1:3
(without chain) /
Frein chainette 1:3
(sans chainette)



REF	∅	U	€	€	cm
D.1013		25	4,80 €	5,52 €	

Rodillo Guía-Hilos
4m Cordón (1,2mm)

Cord Barrel Guide 4m
cord (1,2mm) /
Rouleau Guide Fil
4m corde (1,2mm)



REF	∅	U	€	€	cm
D.1014		25	4,34 €	4,99 €	

Rodillo Guía-Hilos
(sin cordón)

Cord Barrel Guide
(without cord) /
Rouleau Guide Fil
(sans cordon)



REF	∅	U	€	€	cm
D.1014S		25	3,14 €	3,61 €	

Soporte

Brack t /
Support



REF	∅	U	€	€	cm
D.1015		50	0,68 €	0,78 €	

* Soporte incluido en el k t / Brack t supplied in the k t / Support fourni dans le k t.

Soporte con Muelle

Spring Brack t /
Support à Ressort



REF	∅	U	€	€	cm
D.1017		50	0,74 €	0,85 €	

Tapa

Endcap /
Bouchon Final



REF	∅	U	€	€	cm
D.1016		50	0,72 €	0,83 €	

Pletinas
Contrapeso

Battens For
Track Blinds /
Contrepoids Pour
Stores Romain

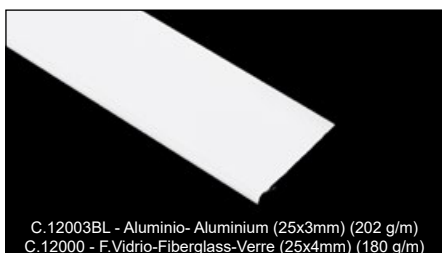







C.12003BL - Aluminio- Aluminium (25x3mm) (202 g/m)
C.12000 - F.Vidrio-Fiberglass-Verre (25x4mm) (180 g/m)

REF	∅	U	€	€	cm
C.12003BL Alum. (202g/m)		60	4,44 €/m	5,11 €/m	600
C.12000 F.Vidrio (180g/m)		60	3,34 €/m	3,84 €/m	600

Accesorios / Accessories / Accessoires

<p>Pletinas Contrapeso Metacrilato Transp. (27x5mm)</p> <p>Transparent Acrylic Batten (27x5mm) / Contrepond Metacrylate Transparente (27x5mm)</p>		<table border="1"> <thead> <tr> <th>REF</th> <th>∅</th> <th>U</th> <th>€</th> <th>€</th> <th>cm</th> </tr> </thead> <tbody> <tr> <td>C.12022TR4000 (161grs/m)</td> <td></td> <td>40</td> <td>7,20€/m</td> <td>8,28 €/m</td> <td>400</td> </tr> </tbody> </table>	REF	∅	U	€	€	cm	C.12022TR4000 (161grs/m)		40	7,20€/m	8,28 €/m	400
REF	∅	U	€	€	cm									
C.12022TR4000 (161grs/m)		40	7,20€/m	8,28 €/m	400									
<p>Protector de Pletina 32 5</p> <p>Protectie Batten 32 5 / Protecteur de Contreponds 32 5</p>		<table border="1"> <thead> <tr> <th>REF</th> <th>∅</th> <th>U</th> <th>€</th> <th>€</th> <th>cm</th> </tr> </thead> <tbody> <tr> <td>D.311</td> <td></td> <td>500</td> <td>0,21 €</td> <td>0,25 €</td> <td></td> </tr> </tbody> </table>	REF	∅	U	€	€	cm	D.311		500	0,21 €	0,25 €	
REF	∅	U	€	€	cm									
D.311		500	0,21 €	0,25 €										
<p>Perfil Contrapeso redondo Blanco (14mm)</p> <p>White round weight profile / Rail contreponds rond blanc</p>		<table border="1"> <thead> <tr> <th>REF</th> <th>∅</th> <th>U</th> <th>€</th> <th>€</th> <th>cm</th> </tr> </thead> <tbody> <tr> <td>C.12024BL</td> <td>14 mm</td> <td>60</td> <td>4,44 €/m</td> <td>5,11 €/m</td> <td>600</td> </tr> </tbody> </table>	REF	∅	U	€	€	cm	C.12024BL	14 mm	60	4,44 €/m	5,11 €/m	600
REF	∅	U	€	€	cm									
C.12024BL	14 mm	60	4,44 €/m	5,11 €/m	600									
<p>Protector Tapón para perfil contrapeso redondo (C.12024BL)</p> <p>Protectie endcap for round weight profile / Embout protecteur pour rail contreponds rond</p>		<table border="1"> <thead> <tr> <th>REF</th> <th>∅</th> <th>U</th> <th>€</th> <th>€</th> <th>cm</th> </tr> </thead> <tbody> <tr> <td>D.312</td> <td>14</td> <td>500</td> <td>0,21 €</td> <td>0,25 €</td> <td></td> </tr> </tbody> </table>	REF	∅	U	€	€	cm	D.312	14	500	0,21 €	0,25 €	
REF	∅	U	€	€	cm									
D.312	14	500	0,21 €	0,25 €										
<p>Varilla de Fibra de Vidrio (4mm)</p> <p>Fiberglass Lath / Jonc Fibre de Verre pour Stores Romain (27x5mm.)</p>		<table border="1"> <thead> <tr> <th>REF</th> <th>∅</th> <th>U</th> <th>€</th> <th>€</th> <th>cm</th> </tr> </thead> <tbody> <tr> <td>D.4600</td> <td>4 mm</td> <td>600</td> <td>0,412 €/m</td> <td>0,494 €/m</td> <td>600</td> </tr> </tbody> </table>	REF	∅	U	€	€	cm	D.4600	4 mm	600	0,412 €/m	0,494 €/m	600
REF	∅	U	€	€	cm									
D.4600	4 mm	600	0,412 €/m	0,494 €/m	600									
<p>Varilla de Fibra de Vidrio (3mm)</p> <p>Fiberglass Lath / Jonc Fibre de Verre pour Stores Romain</p>		<table border="1"> <thead> <tr> <th>REF</th> <th>∅</th> <th>U</th> <th>€</th> <th>€</th> <th>cm</th> </tr> </thead> <tbody> <tr> <td>D.3600</td> <td>3 mm</td> <td>600</td> <td>0,35 €/m</td> <td>0,42 €/m</td> <td>600</td> </tr> </tbody> </table>	REF	∅	U	€	€	cm	D.3600	3 mm	600	0,35 €/m	0,42 €/m	600
REF	∅	U	€	€	cm									
D.3600	3 mm	600	0,35 €/m	0,42 €/m	600									
<p>Varilla de Aluminio</p> <p>Aluminium Shaft / Jonc Aluminium</p>		<table border="1"> <thead> <tr> <th>REF</th> <th>∅</th> <th>U</th> <th>€</th> <th>€</th> <th>cm</th> </tr> </thead> <tbody> <tr> <td>C.12018</td> <td>4 mm</td> <td>60</td> <td>2,60 €/m</td> <td>2,99 €/m</td> <td>6</td> </tr> </tbody> </table>	REF	∅	U	€	€	cm	C.12018	4 mm	60	2,60 €/m	2,99 €/m	6
REF	∅	U	€	€	cm									
C.12018	4 mm	60	2,60 €/m	2,99 €/m	6									
<p>Soporte Techo Soporte plano</p> <p>Ceiling Plain Bracket / Support plafond</p>		<table border="1"> <thead> <tr> <th>REF</th> <th>∅</th> <th>U</th> <th>€</th> <th>€</th> <th>cm</th> </tr> </thead> <tbody> <tr> <td>D.1023</td> <td></td> <td>10</td> <td>1,26 €</td> <td>1,45 €</td> <td></td> </tr> </tbody> </table>	REF	∅	U	€	€	cm	D.1023		10	1,26 €	1,45 €	
REF	∅	U	€	€	cm									
D.1023		10	1,26 €	1,45 €										

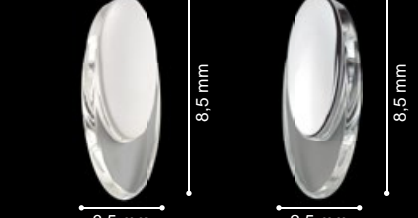
Accesorios / Accessories / Accessoires

<p>Codo estor STARTRACK</p> <p>Roman Blind Elvov Joint / Coude Store Bateaux</p>		<table border="1"> <thead> <tr> <th>REF</th> <th>∅</th> <th></th> <th></th> <th></th> <th></th> </tr> </thead> <tbody> <tr> <td>D.1022</td> <td></td> <td>10</td> <td>23,82 €</td> <td>27,39 €</td> <td></td> </tr> </tbody> </table>	REF	∅					D.1022		10	23,82 €	27,39 €																			
REF	∅																															
D.1022		10	23,82 €	27,39 €																												
<p>Cordón (Bobina) 1,2mm</p> <p>Cord (Spool) 1,2mm / Corde 1,2mm</p>		<table border="1"> <thead> <tr> <th>REF</th> <th>∅</th> <th></th> <th></th> <th></th> <th></th> </tr> </thead> <tbody> <tr> <td>D.09</td> <td>12 mm</td> <td>500 m</td> <td>77,16 €</td> <td></td> <td></td> </tr> <tr> <td>D.09C</td> <td>12 mm</td> <td>1000 m</td> <td>79,42 €</td> <td></td> <td></td> </tr> </tbody> </table>	REF	∅					D.09	12 mm	500 m	77,16 €			D.09C	12 mm	1000 m	79,42 €														
REF	∅																															
D.09	12 mm	500 m	77,16 €																													
D.09C	12 mm	1000 m	79,42 €																													
<p>Rollo Cadeneta</p> <p>Chain Roll / Rouleau</p>		<table border="1"> <thead> <tr> <th>REF</th> <th>∅</th> <th></th> <th></th> <th></th> <th></th> </tr> </thead> <tbody> <tr> <td>D.74</td> <td></td> <td>200 m</td> <td>1,40 €/m</td> <td>1,68 €/m</td> <td></td> </tr> <tr> <td>D.74PL</td> <td></td> <td>150 m</td> <td>1,40 €/m</td> <td>1,68 €/m</td> <td></td> </tr> </tbody> </table>	REF	∅					D.74		200 m	1,40 €/m	1,68 €/m		D.74PL		150 m	1,40 €/m	1,68 €/m													
REF	∅																															
D.74		200 m	1,40 €/m	1,68 €/m																												
D.74PL		150 m	1,40 €/m	1,68 €/m																												
<p>Cadeneta Sin Fin</p> <p>Continuous Chain / Chainette</p>		<table border="1"> <thead> <tr> <th>REF</th> <th>∅</th> <th></th> <th></th> <th></th> <th></th> </tr> </thead> <tbody> <tr> <td>D.70</td> <td></td> <td>20</td> <td>2,48 €</td> <td>2,98 €</td> <td>200</td> </tr> <tr> <td>D.73</td> <td></td> <td>20</td> <td>3,50 €</td> <td>4,20 €</td> <td>300</td> </tr> <tr> <td>D.71</td> <td></td> <td>20</td> <td>4,32 €</td> <td>4,97 €</td> <td>400</td> </tr> <tr> <td>D.73PL</td> <td></td> <td>20</td> <td>4,98 €</td> <td>5,73 €</td> <td>300</td> </tr> </tbody> </table>	REF	∅					D.70		20	2,48 €	2,98 €	200	D.73		20	3,50 €	4,20 €	300	D.71		20	4,32 €	4,97 €	400	D.73PL		20	4,98 €	5,73 €	300
REF	∅																															
D.70		20	2,48 €	2,98 €	200																											
D.73		20	3,50 €	4,20 €	300																											
D.71		20	4,32 €	4,97 €	400																											
D.73PL		20	4,98 €	5,73 €	300																											
<p>Contrapeso Mini (43 g aprox.)</p> <p>Mini-cordweight / Mini-contrepois</p>		<table border="1"> <thead> <tr> <th>REF</th> <th>∅</th> <th></th> <th></th> <th></th> <th></th> </tr> </thead> <tbody> <tr> <td>I.1110BL</td> <td></td> <td>25</td> <td>1,40 €</td> <td>1,61 €</td> <td></td> </tr> <tr> <td>I.1110PL</td> <td></td> <td>25</td> <td>2,12 €</td> <td>2,44 €</td> <td></td> </tr> </tbody> </table>	REF	∅					I.1110BL		25	1,40 €	1,61 €		I.1110PL		25	2,12 €	2,44 €													
REF	∅																															
I.1110BL		25	1,40 €	1,61 €																												
I.1110PL		25	2,12 €	2,44 €																												
<p>Contrapeso (23 g aprox.)</p> <p>Mini-cordweight / Mini-contrepois</p>		<table border="1"> <thead> <tr> <th>REF</th> <th>∅</th> <th></th> <th></th> <th></th> <th></th> </tr> </thead> <tbody> <tr> <td>I.1111BL</td> <td></td> <td>25</td> <td>1,18 €</td> <td>1,36 €</td> <td></td> </tr> <tr> <td>I.1111PL</td> <td></td> <td>25</td> <td>2,46 €</td> <td>2,83 €</td> <td></td> </tr> </tbody> </table>	REF	∅					I.1111BL		25	1,18 €	1,36 €		I.1111PL		25	2,46 €	2,83 €													
REF	∅																															
I.1111BL		25	1,18 €	1,36 €																												
I.1111PL		25	2,46 €	2,83 €																												
<p>Empalme Cadeneta</p> <p>Chain Splice / Raccord de Chainette</p>		<table border="1"> <thead> <tr> <th>REF</th> <th>∅</th> <th></th> <th></th> <th></th> <th></th> </tr> </thead> <tbody> <tr> <td>D.40</td> <td></td> <td>200</td> <td>0,206 €</td> <td>0,247 €</td> <td></td> </tr> <tr> <td>D.41</td> <td></td> <td>500</td> <td>1,80 €</td> <td>2,16 €</td> <td></td> </tr> </tbody> </table>	REF	∅					D.40		200	0,206 €	0,247 €		D.41		500	1,80 €	2,16 €													
REF	∅																															
D.40		200	0,206 €	0,247 €																												
D.41		500	1,80 €	2,16 €																												
<p>Anilla de Plástico</p> <p>Plastic Rings / Anneau Plastique</p>		<table border="1"> <thead> <tr> <th>REF</th> <th>∅</th> <th></th> <th></th> <th></th> <th></th> </tr> </thead> <tbody> <tr> <td>D.32</td> <td></td> <td>1000</td> <td>34,66 €</td> <td></td> <td></td> </tr> </tbody> </table>	REF	∅					D.32		1000	34,66 €																				
REF	∅																															
D.32		1000	34,66 €																													

NEW

Accesorios / Accessories / Accessoires

Anilla de Plástico
(9x13mm)

Plastic Rings
(9x13mm) /
Anneau Plastique
(9x13mm)



REF	∅	U	€	€	cm
D.38		1000	37,74 €		

Anilla de Plástico

Plastic Rings /
Anneau Plastique



REF	∅	U	€	€	cm
D.24		1000	34,68 €		

Cinta para Varilla
Estor (16mm)

Roman Blind
LathTape /
Ruban pour Barre
de Store Romain

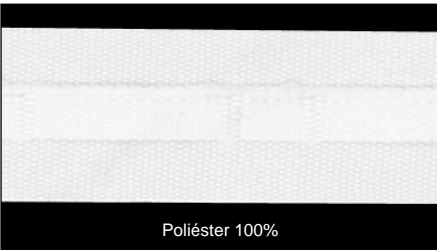

Poliéster 100%

REF	COLOR	U	€	RAPPORT	mm
D.14	blanco/white	300 m	0,31 €/m	-	20 mm

Cinta Cierre-Velcro
Hembra 20mm.

20 mm Touch&close
fastener Tape
(Loop section) /
Velcro femelle
20mm.

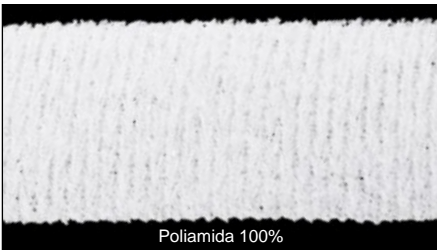

Poliamida 100%

REF	COLOR	U	€	RAPPORT	mm
D.20A (Velour)	blanco/white	50 m	0,60 €/m	-	20
D.5 (Astrakan)	blanco/white	50 m	0,41 €/m	-	20
D.5AD (Astrakan Adhes.)	blanco/white	50 m	0,92 €/m	-	20

Soporte Múltiple
de Pared Blanco

White Wall
Extension Bracket /
Support Mural
Blanc



REF	∅	U	€	€	cm
D.301BL		25	1,98 €	2,38 €	4
D.302BL		25	2,08 €	2,50 €	6
D.303BL		25	2,36 €	2,83 €	10
D.304BL		25	3,00 €	3,60 €	15
D.305BL		25	4,78 €	5,74 €	20

Soporte Múltiple de
Pared Ek rafuerte

Wall Ek ension
Bracket
(Extrastrong) /
Support Mural
Ek rafort



REF	∅	U	€	€	cm
D.3001BL		25	3,46 €	3,98 €	7
D.3002BL		25	4,16 €	4,78 €	11
D.3003BL		25	4,94 €	5,68 €	15
D.3004BL		25	5,18 €	5,96 €	19
D.3005BL		25	5,38 €	6,19 €	23

Muestra estor
STARTRACK

Demo sample
Startrack
roman blind /
Echantillon stores
bateaux Startrack



REF	∅	U	€	€	cm
M.305		1		13,50 €	

STARTRACK (Motorizado) / STARTRACK (Motorized system) / STARTRACK (avec Motor)



EASY COMPACT (Motorizado) / EASY COMPACT (Motorized system) / EASY COMPACT (avec Motor)



2 Opciones de Motorización:

- Kit Motorización **DC** Completo Incluye : Motor y Transformador
- Kit Motorización **Batería Externa** Completo Incluye : Motor y Carcasa para batería y Soportes.

Características Técnicas Motor

- El Receptor está integrado en el motor.
- Funciona por radiofrecuencia, con mando a distancia de 15 canales con un alcance de 35 m.
- La programación del sistema es muy fácil y rápida.
- Ancho mínimo del riel: 500 mm.
- Largo máximo del riel: 3 metros.
- Área máxima de arrastre 8m2.
- Final de carrera electrónico con receptor integrado.
- Protección contra sobrecargas eléctricas.
- Parada automática al finalizar su recorrido.
- Peso máximo soportado 4 Kg (peso total de la cortina).
- No permite conexión Domótica.
- Rango Temperatura: 0º- 40º Centígrados.
- Altran ofrece una **Garantía de 2 años** para todos sus Motores, a partir de la fecha de factura, salvo mal uso o rotura por parte del cliente-usuario-instalador.



Esquema de conexión DC

Scheme DC connection / Schéma de branchement DC:



Esquema de conexión Batería Externa

Scheme External Battery connection / Schéma de branchement batterie externe:

2 Motorized Options:

- Motorized **DC** kit including: motor and adaptor.
- Motorized Kit with **External Battery** including: motor, battery housing, and brackets.

Motor Technical Features

- Built-in receiver.
- Radiofrequency works with a 15channel remote control (35m operative range).
- Fast and easy programming.
- Minimum blind width: 500 mm.
- Maximum blind length: 3 meters.
- Load maximum allowable area: 8 m2
- Electronic end limit with built-in receiver
- Electrical overload protection feature.
- Motor switches off automatically when limits are reached.
- Maximum blind weight: 4 kg .
- Home Automation System is not applicable.
- Temperature Range: 0º - 40º Centigrade.
- Altran offers a **2 year warranty** for all motors, from the date of invoice, unless misuse or failure by the customer-user-installer.

2 Options de Systèmes de Motorisation:

- Kit **DC** motorisé en incluant: moteur et transformateur.
- Kit motorisé avec **Batterie Externe** en incluant: moteur, logement batterie et supports.

Caractéristique Technique Moteur

- Récepteur intégré dans le moteur
- Fonctionne pour radiofréquences avec télécommande de 15 canaux avec une portée de 35m.
- La programmation est très simple et rapide.
- Largeur minimum du rail: 500 mm.
- Longueur maximum du rail: 3 mètres.
- Domaine de poussée maximum 8m2.
- Fin de course électronique avec récepteur intégré.
- Protection contre les surcharges électriques.
- Arrêt automatique à la fin du parcours.
- Poids maximum supporté: 4 kg (poids total du rideau).
- Ne permet pas Système Domotique.
- Température: 0º - 40º Centigrade.
- Altran offre une **garantie de 2 ans** pour tous les moteurs, à partir de la date de la facture, sauf utilisation incorrecte par le client-utilisateur-installeur.

EASY COMPACT & STARTRACK: Kit Motorización / Motorized Kit / Kit Motorisé

STARTRACK y EASY COMPACT MOTOR	REF	Motor Motor Moteur D.1018	Acoples Adaptor Transformateur D.1040	Soporte Motor Brackets Motor Moteur Support			
	D.1005 - Kit Motorización DC Motorized Kit DC Kit Motorisé DC	D.1005	1	1	1	1	186,96 €
D.1006 - Kit Motorización Batería Externa Motorized Kit External Battery Kit Motorisé Batterie Externe	D.1006	1	1	1	1	186,96 €	

Accesorios Startrack y Easy Compact / Startrack and Easy Compact Accessories / Accessoires Startrack et Easy Compact

Motor 12V DC
0,8Nm, 13W,
1,1A, 34rpm

Motor /
Moteur



REF					
D.1018		1		149,88 €	

Mando a Distancia
LED 15 canales

Remote Control
LED 15 channels /
Télécommande
LED 15 canaux



REF					
D.1041		1		53,28 €	

Transformador

Adaptor /
Transformateur



REF					
D.1040		1		37,08 €	

Carcasa para
Pilas (Kit Batería)

External battery
housing /
Logement
externe batterie

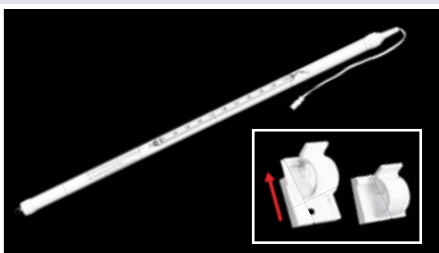

REF					
D.1046		1		37,08 €	



Características Batería Externa:

Funciona con 10 pilas AA (pilas no incluidas).

Test de funcionamiento de la Batería Externa:

- Tramo recorrido: 1,6 m.
- Peso arrastrado: 4 kg.
- Nº de repeticiones del movimiento: 230 ciclos.



Technical Features of External Battery:

Powered by 10 AA batteries (not included)

Running test of external battery

- Distance measured: 1,6m.
- Carried weight: 4 kg.
- Number of repetitions of the movement: 230 cycles.



Caractéristique Technique Batterie Externe:

Fonctionnant sur 10 piles AA (non incluses)

Test de fonctionnement de la batterie externe:

- Section du parcours: 1.6M
- Poids des charge trainées: 4 kg.
- Nombre de répétitions du mouvement: 230 cycles.

CADENETA (Accionamiento Cadeneta) / CADENETA (Chain system) / CADENETA avec chaînette

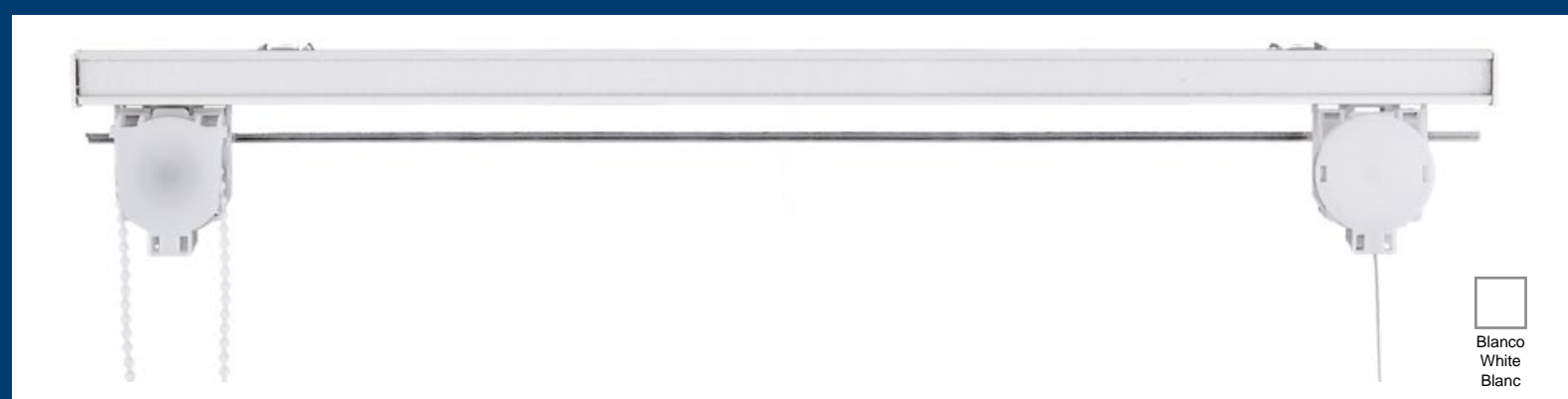

CADENETA	REF	Soportes Brackets Supports	Correderas Gliders Glisseur					
Conjuntos completos CON VARILLAS / Complete sets WITH LATHS / Kits complets AVEC JONCS	D.7075T	2	2	6	34,74 €	39,95 €	75	300
	D.7100T	2	2	6	39,06 €	44,92 €	100	300
	D.7125T	3	2	6	44,08 €	50,69 €	125	300
	D.7150T	3	3	6	55,18 €	63,46 €	150	300
	D.7175T	3	3	6	59,62 €	68,56 €	175	300
	D.7200T	4	3	6	63,56 €	73,09 €	200	300
	D.7225T	4	3	6	68,48 €	78,75 €	225	300
	D.7250T	4	4	6	79,42 €	91,33 €	250	300
	D.7275T	5	4	6	87,84 €	101,02 €	275	300
	D.7300T	5	4	6	91,90 €	105,69 €	300	300

CADENETA	REF	Soportes Brackets Supports	Correderas Gliders Glisseur					
Conjuntos completos SIN VARILLAS / Complete sets WITHOUT LATHS / Kits complets SANS JONCS	D.6075T	2	2	6	31,80 €	36,57 €	75	300
	D.6100T	2	2	6	35,16 €	40,43 €	100	300
	D.6125T	3	2	6	39,26 €	45,15 €	125	300
	D.6150T	3	3	6	49,06 €	56,42 €	150	300
	D.6175T	3	3	6	52,42 €	60,28 €	175	300
	D.6200T	4	3	6	55,80 €	64,17 €	200	300
	D.6225T	4	3	6	59,14 €	68,01 €	225	300
	D.6250T	4	4	6	69,44 €	79,86 €	250	300
	D.6275T	5	4	6	73,54 €	84,57 €	275	300
	D.6300T	5	4	6	76,50 €	87,98 €	300	300

Información General / General Information / Informations Générales

Todos los estores se pueden cortar a medida, sin incremento de precio.

Todos los estores pre-montados se montan con el freno para cortinas de un peso máximo de 2 kg.

Para cortinas más pesadas (máximo 4,5 kg.) debe utilizarse el freno superior que se vende al mismo precio.

Los estores pre-montados en kits contienen los siguientes componentes:

Riel de aluminio con lacerado.....Longitud
Freno cadeneta (2kg.) 1:1.....1
Guía galón montada.....Ver tabla
Varillas de Fibra de Vidrio (4mm).....Longitud x 7
Pletina contrapeso de aluminio.....Longitud
Anillas.....Nº Guías x 7
Soportes (4cm)Ver tabla
Varilla cuadrada de aluminio.....Longitud
Cadeneta sin fin.....3 m
Tapas laterales.....2
Velcro hembra.....Longitud
Clip galón.....Ref: D.43

All blinds can be cut to measure without price increase. All the pre-assembled blinds in kits are supplied with the locking mechanism for blinds weighing a maximum of 2 kg. Should a heavier blind be used, a more heavy duty locking mechanism (maximum 4,5 kg.) can be supplied upon request, at no extra cost.

The pre-assembled tracks supplied in kits contain the following components:

Aluminium track with bonded velcro...Length
Chain sidewinder
locking mechanism (2kg) 1:1.....1
Assembled tape Guides.....See table
Fiberglass Laths (4mm).....Length x 7
Aluminium batten.....Length
Rings.....Nº Guides x 7
Brackets (4cm)See Table
Square aluminium rod.....Length
Continuous chain.....3 m
Endcaps.....2
Velcro tape (loop section).....Length
Plastic end caps.....Ref: D.43

Tous les stores peuvent être coupés à la mesure sans supplément prix

Tous les kits pré-assemblés comportent un mécanisme de blocage pour des stores de 2 kg. max.

Pour des stores plus lourds (max. 4,5 kg.) le mécanisme peut être fourni sans coût supplémentaire.

Les rails fournis dans le kit contiennent les suivants composants:

Rail Aluminium.....Largeur
Mechanism blocage 1:1.....1
Guide rubans.....Voir table
Jonc de Fibre de Verre (4mm).....Largeur x 7
Pletine Aluminium.....Largeur
AnneauxNº Guides x 7
Supports (4cm).....Voir table
Barre carrée aluminiumLargeur
Chaîne.....3 m
Bouchon final.....2
Velcro femelleLargeur
Bouchon final Plastique.....Ref: D.43

Accesorios / Accessories / Accessoires

Riel de Aluminio
Velcrado
(11x23mm)

Track With
Bonded Velcro /
Rail avec Velcro



REF	∅	U	€	€	cm
C.12017BL		60	4,74 €/m	5,45 €/m	600

Soporte 7 cm

Bracket /
Support



REF	∅	U	€	€	cm
D.35		50	1,00 €	1,20 €	7

Soporte 4 cm

Bracket /
Support



REF	∅	U	€	€	cm
D.39		50	0,70 €	0,84 €	4

* Soporte incluido en el kit / Bracket supplied in the kit / Support fourni dans le kit.

Soporte 3 cm

Bracket /
Support



REF	∅	U	€	€	cm
D.53		50	0,80 €	0,92 €	3

Soporte techo

Bracket /
Support



REF	∅	U	€	€	cm
D.34		50	0,432 €	0,518 €	3

Soporte palanca 20

Bracket /
Support



REF	∅	U	€	€	cm
D.80		50	0,54 €	0,65 €	

Soporte palanca 30

Bracket /
Support



REF	∅	U	€	€	cm
D.81		50	0,72 €	0,83 €	

Soporte palanca 60

Bracket /
Support



REF	∅	U	€	€	cm
D.82		50	0,78 €	0,90 €	

Accesorios / Accessories / Accessoires

Tapa Lateral de Riel

Plastic end Cap /
Bouchon Final
Plastique



REF	∅				
D.37		100	0,184 €	0,221 €	

Clip de Galón

Plastic end Cap /
Bouchon Final
Plastique



REF	∅				
D.43		100	0,66 €	0,76 €	

Freno Cadeneta

Chain Sidewinder
Locking Mech. /
Frein chainette



REF	∅				
D.76 (1:1)		20	4,90 €	5,88 €	
D.77 (1:5)		20	4,90 €	5,88 €	

Guía Galón

Tape Guide /
Guide Ruban



REF	∅				
D.79		20	3,88 €	4,66 €	

Guía Galón Montada
(montada con 3m de
cinta de 6mm de ancho)
Assembled Tape Guide
(includes 3 mt tape of
6mm tape) /
Guide Ruban Ensam-
blée (inclus 3 mt ruban,
ruban 6mm)



REF	COLOR				
D.79M	transparente	20	5,28 €	6,07 €	6 mm
D.79MBL	blanco/white	20	5,28 €	6,07 €	6 mm

Corredera de Plástico

Plastic glider /
Glisseur Plastique



REF	∅				
D.999		1000	0,062 €	0,074 €	

Varilla de Fibra de Vidrio

Fiberglass Lath /
Jonc Fibre de Verre
pour Stores Romain



REF	∅				
D.3600	3 mm	600	0,35 €/m	0,42 €/m	600
D.4600	4 mm	600	0,412 €/m	0,494 €/m	600

Varilla Cuadrada de Aluminio

Square
Aluminium Rod /
Barre Carrée en
Aluminium



REF	∅				
C.12018	5 mm	60	2,60 €/m	2,99 €/m	600

Accesorios / Accessories / Accessoires

Empalme

Splice /
Raccordeur

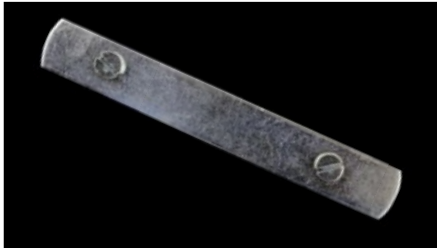

REF	∅	U	€	€	cm
D.30		50	0,98 €	1,18 €	

Pletinas
Contrapeso

Battens For
Track Blinds /
Contrepoids Pour
Stores Romain

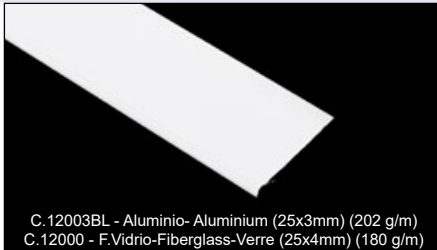

C.12003BL - Aluminio- Aluminium (25x3mm) (202 g/m)
C.12000 - F.Vidrio-Fiberglass-Verre (25x4mm) (180 g/m)

REF	∅	U	€	€	cm
C.12003BL Alum. (202g/m)		60	4,44 €/m	5,11 €/m	600
C.12000 F.Vidrio (180g/m)		60	3,34 €/m	3,84 €/m	600

Pletinas Contrapeso
Metacrilato Transp.
(27x5mm)

Transparent Acrylic
Batten (27x5mm) /
Contrepoid Metacrylate
Transparente
(27x5mm)



REF	∅	U	€	€	cm
C.12022TR4000 (161grs/m)		40	7,20 €/m	8,28 €/m	400

Protector
de Pletina 32 5

Protectie
Batten 32 5 /
Batôn
Protecteur 32 5



REF	∅	U	€	€	cm
D.311		500	0,21 €	0,25 €	

Codo Plástico

Plastic Elbow /
Coude Plastique



REF	∅	U	€	€	cm
D.31		50	1,52 €	1,82 €	

Cordón Contrapeso

Lead Weight Tape /
Corde Plombé



REF	∅	U	€	€	cm
D.51 (22 gr/m)		50 m	0,84 €/m		
D.52 (70 gr/m)		50 m	2,10 €/m		

Empalme
Cadeneta

Chain Splice /
Raccord de
Chainette

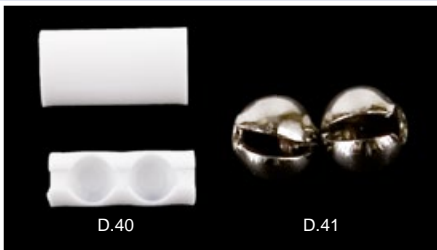

D.40

D.41

REF	∅	U	€	€	cm
D.40		200	0,206 €	0,247 €	
D.41		500	1,80 €	2,16 €	

Rollo Cadeneta

Chain Roll /
Rouleau



D.74

D.74PL

REF	∅	U	€	€	cm
D.74		200 m	1,40 €/m	1,68 €/m	
D.74PL		150 m	1,40 €/m	1,68 €/m	

Accesorios / Accessories / Accessoires

<p>Cadeneta Sin Fin Continuous Chain / Chainette</p>		<table border="1"> <thead> <tr> <th>REF</th> <th>∅</th> <th></th> <th></th> <th></th> <th></th> </tr> </thead> <tbody> <tr> <td>D.70</td> <td></td> <td>20</td> <td>2,48 €</td> <td>2,98 €</td> <td>2</td> </tr> <tr> <td>D.73</td> <td></td> <td>20</td> <td>3,50 €</td> <td>4,20 €</td> <td>3</td> </tr> <tr> <td>D.71</td> <td></td> <td>20</td> <td>4,32 €</td> <td>4,97 €</td> <td>4</td> </tr> <tr> <td>D.73PL</td> <td></td> <td>20</td> <td>4,98 €</td> <td>5,73 €</td> <td>3</td> </tr> </tbody> </table>	REF	∅					D.70		20	2,48 €	2,98 €	2	D.73		20	3,50 €	4,20 €	3	D.71		20	4,32 €	4,97 €	4	D.73PL		20	4,98 €	5,73 €	3
REF	∅																															
D.70		20	2,48 €	2,98 €	2																											
D.73		20	3,50 €	4,20 €	3																											
D.71		20	4,32 €	4,97 €	4																											
D.73PL		20	4,98 €	5,73 €	3																											
<p>Contrapeso Mini (43 g aprox.) Mini-cordweight / Mini-contrepois</p>		<table border="1"> <thead> <tr> <th>REF</th> <th>∅</th> <th></th> <th></th> <th></th> <th></th> </tr> </thead> <tbody> <tr> <td>I.1110BL</td> <td></td> <td>25</td> <td>1,40 €</td> <td>1,61 €</td> <td></td> </tr> <tr> <td>I.1110PL</td> <td></td> <td>25</td> <td>2,12 €</td> <td>2,44 €</td> <td></td> </tr> </tbody> </table>	REF	∅					I.1110BL		25	1,40 €	1,61 €		I.1110PL		25	2,12 €	2,44 €													
REF	∅																															
I.1110BL		25	1,40 €	1,61 €																												
I.1110PL		25	2,12 €	2,44 €																												
<p>Contrapeso (23 g aprox.) Mini-cordweight / Mini-contrepois</p>		<table border="1"> <thead> <tr> <th>REF</th> <th>∅</th> <th></th> <th></th> <th></th> <th></th> </tr> </thead> <tbody> <tr> <td>I.1111BL</td> <td></td> <td>25</td> <td>1,18 €</td> <td>1,36 €</td> <td></td> </tr> <tr> <td>I.1111PL</td> <td></td> <td>25</td> <td>2,46 €</td> <td>2,83 €</td> <td></td> </tr> </tbody> </table>	REF	∅					I.1111BL		25	1,18 €	1,36 €		I.1111PL		25	2,46 €	2,83 €													
REF	∅																															
I.1111BL		25	1,18 €	1,36 €																												
I.1111PL		25	2,46 €	2,83 €																												
<p>Cinta para Varilla Estor (16mm) Roman Blind LathTape / Ruban pour Barre de Store Romain</p>	<p>Poliéster 100%</p>	<table border="1"> <thead> <tr> <th>REF</th> <th>COLOR</th> <th></th> <th></th> <th>RAPPORT</th> <th></th> </tr> </thead> <tbody> <tr> <td>D.14</td> <td>blanco/white</td> <td>300 m</td> <td>0,31 €/m</td> <td>-</td> <td>20 mm</td> </tr> </tbody> </table>	REF	COLOR			RAPPORT		D.14	blanco/white	300 m	0,31 €/m	-	20 mm																		
REF	COLOR			RAPPORT																												
D.14	blanco/white	300 m	0,31 €/m	-	20 mm																											
<p>Cinta Cierre-Velcro Hembra 20mm. 20 mm Touch&close fastener Tape (Loop section) / Velcro femelle 20mm.</p>	<p>Poliamida 100%</p>	<table border="1"> <thead> <tr> <th>REF</th> <th>COLOR</th> <th></th> <th></th> <th>RAPPORT</th> <th></th> </tr> </thead> <tbody> <tr> <td>D.20A (Velour)</td> <td>blanco/white</td> <td>50 m</td> <td>0,60 €/m</td> <td>-</td> <td>20</td> </tr> <tr> <td>D.5 (Astrakan)</td> <td>blanco/white</td> <td>50 m</td> <td>0,41 €/m</td> <td>-</td> <td>20</td> </tr> <tr> <td>D.5AD (Astrakan Adhes.)</td> <td>blanco/white</td> <td>50 m</td> <td>0,92 €/m</td> <td>-</td> <td>20</td> </tr> </tbody> </table>	REF	COLOR			RAPPORT		D.20A (Velour)	blanco/white	50 m	0,60 €/m	-	20	D.5 (Astrakan)	blanco/white	50 m	0,41 €/m	-	20	D.5AD (Astrakan Adhes.)	blanco/white	50 m	0,92 €/m	-	20						
REF	COLOR			RAPPORT																												
D.20A (Velour)	blanco/white	50 m	0,60 €/m	-	20																											
D.5 (Astrakan)	blanco/white	50 m	0,41 €/m	-	20																											
D.5AD (Astrakan Adhes.)	blanco/white	50 m	0,92 €/m	-	20																											
<p>Cinta Galón Tape / Rubán</p>		<table border="1"> <thead> <tr> <th>REF</th> <th>∅</th> <th></th> <th></th> <th></th> <th></th> </tr> </thead> <tbody> <tr> <td>D.17</td> <td></td> <td>400 m</td> <td>0,25 €/m</td> <td></td> <td></td> </tr> </tbody> </table>	REF	∅					D.17		400 m	0,25 €/m																				
REF	∅																															
D.17		400 m	0,25 €/m																													
<p>Anilla de Plástico Plastic Rings / Anneau Plastique</p>		<table border="1"> <thead> <tr> <th>REF</th> <th>∅</th> <th></th> <th></th> <th></th> <th></th> </tr> </thead> <tbody> <tr> <td>D.32</td> <td></td> <td>1000</td> <td>34,66 €</td> <td></td> <td></td> </tr> </tbody> </table>	REF	∅					D.32		1000	34,66 €																				
REF	∅																															
D.32		1000	34,66 €																													
<p>Anilla de Plástico (9x13mm) Plastic Rings (9x13mm) / Anneau Plastique (9x13mm)</p>		<table border="1"> <thead> <tr> <th>REF</th> <th>∅</th> <th></th> <th></th> <th></th> <th></th> </tr> </thead> <tbody> <tr> <td>D.38</td> <td></td> <td>1000</td> <td>37,74 €</td> <td></td> <td></td> </tr> </tbody> </table>	REF	∅					D.38		1000	37,74 €																				
REF	∅																															
D.38		1000	37,74 €																													

NEW

Accesorios / Accessories / Accessoires

Anilla de Plástico

Plastic Rings /
Anneau Plastique



REF	∅	U	€	€	cm
D.24		1000	34,68 €		

Soporte múltiple
de pared Zincado

Wall Ek ension
Brack t /
Support Mural

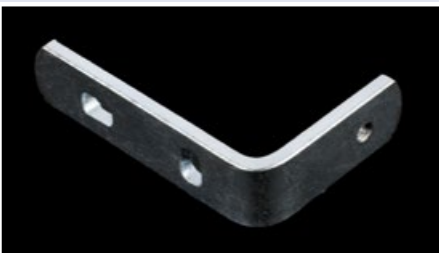

REF	∅	U	€	€	cm
D.301Z		25	1,28 €	1,54 €	4
D.302Z		25	1,48 €	1,78 €	6
D.303Z		25	1,80 €	2,16 €	10
D.304Z		25	2,30 €	2,76 €	15

Soporte Múltiple
de Pared Blanco

Whit Wall
Ek ension Brack t /
Support
Mural Blanc



REF	∅	U	€	€	cm
D.301BL		25	1,98 €	2,38 €	4
D.302BL		25	2,08 €	2,50 €	6
D.303BL		25	2,36 €	2,83 €	10
D.304BL		25	3,00 €	3,60 €	15
D.305BL		25	4,78 €	5,74 €	20

Soporte Múltiple de
Pared Ek rafuerte

Wall Ek ension
Brack t
(Extrastrong) /
Support Mural
Ek rafort



REF	∅	U	€	€	cm
D.3001BL		25	3,46 €	3,98 €	7
D.3002BL		25	4,16 €	4,78 €	11
D.3003BL		25	4,94 €	5,68 €	15
D.3004BL		25	5,18 €	5,96 €	19
D.3005BL		25	5,38 €	6,19 €	23

Muestra estor
CADENETA

Demo sample
Cadeneta
roman blind /
Echantillon stores
bateaux Cadeneta



REF	∅	U	€	€	cm
M.306		1		11,22 €	

Estor Troya (Accionamiento Cordón) / Roman blind (cord - drawn) / Store bateau (tirage á cordon)



Blanco
White
Blanc

TROYA NORMAL Cordón Conjuntos completos CON VARILLAS / Complete sets WITH LATHS / Kits complets AVEC JONCS	REF	Soportes Brackets Supports	Correderas Gliders Glisseur					
	* Cintas de confección no incluidas / * Curtain Tapes not included / * Rubans de Rideau non inclus	D.5075	2	2	10	20,52 €	23,60 €	75
	D.5100	2	2	10	24,52 €	28,20 €	100	210
	D.5125	3	3	10	29,94 €	34,43 €	125	210
	D.5150	3	3	10	33,92 €	39,01 €	150	210
	D.5175	3	3	10	37,90 €	43,59 €	175	210
	D.5200	4	4	10	41,90 €	48,19 €	200	210
	D.5225	4	4	10	54,32 €	62,47 €	225	210
	D.5250	4	4	10	56,96 €	65,50 €	250	210
	D.5275	5	5	10	62,01 €	71,30 €	275	210
	D.5300	5	5	10	66,34 €	76,29 €	300	210

TROYA NORMAL Cordón Conjuntos completos SIN VARILLAS / Complete sets WITHOUT LATHS / Kits complets SANS JONCS	REF	Soportes Brackets Supports	Correderas Gliders Glisseur					
	* Cintas de confección no incluidas / * Curtain Tapes not included / * Rubans de Rideau non inclus	D.4075	2	2	10	15,62 €	17,96 €	75
	D.4100	2	2	10	18,88 €	21,71 €	100	210
	D.4125	3	3	10	23,96 €	27,55 €	125	210
	D.4150	3	3	10	26,98 €	31,03 €	150	210
	D.4175	3	3	10	30,24 €	34,78 €	175	210
	D.4200	4	4	10	34,10 €	39,22 €	200	210
	D.4225	4	4	10	40,48 €	46,55 €	225	210
	D.4250	4	4	10	41,92 €	48,21 €	250	210
	D.4275	5	5	10	48,34 €	55,59 €	275	210
	D.4300	5	5	10	54,80 €	63,02 €	300	210

Información General / General Information / Informations Générales

- Estor Troya (Accionamiento Cordón).
Riel de aluminio con los accesorios necesarios para la confección de estores (Elevación Vertical).
Todos los estores se pueden cortar a medida, sin incremento de precio.
- Track for festoon, roman & austrian blinds TROYA, (Cord-Drawn).
Aluminium track with all its accessories for making festoon, roman and austrian blinds.
Cut to measure without extra charge.
- Rail pour festonné, romain et autrichien TROYA (Tirage avec Corde).
Rail aluminium avec tous les accessoires pour la confection de stores.
Coupe à mesure sans coût supplémentaire.

Estor con soporte BOTÓN (Cordón) / Roman blind with BUTTON bracket / Store bateau avec support BOUTON



Blanco
White
Blanc

TROYA BOTÓN Cordón	REF	Soportes Brackets Supports	Correderas Gliders Glisseur	U	€	€	cm	cm
Conjuntos completos CON VARILLAS / Complete sets WITH LATHS / Kits complets AVEC JONCS * Cintas de confección no incluidas / * Curtain Tapes not included / * Rubans de Rideau non inclus	D.960	2	2	10	24,28 €	27,92 €	75	210
	D.961	2	2	10	27,26 €	31,35 €	100	210
	D.962	3	3	10	33,40 €	38,41 €	125	210
	D.963	3	3	10	37,28 €	42,87 €	150	210
TROYA BOTÓN Cordón	REF	Soportes Brackets Supports	Correderas Gliders Glisseur	U	€	€	cm	cm
Conjuntos completos SIN VARILLAS / Complete sets WITHOUT LATHS / Kits complets SANS JONCS * Cintas de confección no incluidas / * Curtain Tapes not included / * Rubans de Rideau non inclus	D.970	2	2	10	20,46 €	23,53 €	75	210
	D.971	2	2	10	23,36 €	26,86 €	100	210
	D.972	3	3	10	28,52 €	32,80 €	125	210
	D.973	3	3	10	33,28 €	38,27 €	150	210

Información General / General Information / Informations Générales

Los estores pre-montados en kits contienen los siguientes componentes:

- Riel de aluminio con rielado.....Longitud
- Freno estor.....1
- Soportes.....Ver tabla
- Guía Cordón.....Ver tabla
- Tapas laterales.....2
- Varillas de Fibra de Vidrio (4mm).....Longitud x 7
- Pletina contrapeso de aluminio.....Longitud
- Bola empalme hilos.....1
- Cordón.....15 m
- Velcro hembra.....Longitud
- Anillas.....Nº guías x 7
- Anillas pera.....Nº guías x 1
- Contrapeso de madera.....1

The pre-assembled tracks supplied in kits contain the following components:

- Aluminium track with bonded velcro.....Length
- Cord lock1
- Brackets.....See Table
- Cord Guide.....See Table
- Plastic endcaps.....2
- Fiberglass Laths (4mm).....Length x 7
- Aluminium batten.....Length
- Plastic cord connector.....1
- Cord.....15 m
- Velcro tape (loop section).....Length
- Rings.....Nº Guides x 7
- Plastic Rings.....Nº Guides x 1
- Wooden cord weight.....1

Les rails fournis dans le kit contiennent les suivants composants:

- Rail Aluminium.....Largeur
- Frein.....1
- Supports.....Voir tableau
- Guide Cordón.....Voir tableau
- Bouchon final.....2
- Jonc de Fibre de Verre(4mm)...Largeur x 7
- Pletine aluminium.....Largeur
- Chaine connecteur.....1
- Corde.....15 m
- Velcro fermelle.....Larguer
- AnneauxNº Guides x 7
- Anneaux Plastique.....Nº Guides x 1
- Contrepoids en bois.....1

Estor Troya CON SOPORTE BOTÓN (Accionamiento Cordón).
Riel de aluminio con los accesorios necesarios para la confección de estores (Elevación Vertical).
Todos los estores se pueden cortar a medida, sin incremento de precio.

Track for festoon, roman & austrian blinds TROYA, with button bracket (Cord-Drawn).
Aluminium track with all its accessories for making festoon, roman and austrian blinds.
Cut to measure without extra charge.

Rail pour festonné, Romain et autrichien TROYA avec support BOUTON (Tirage avec Corde).
Rail aluminium avec tous les accessoires pour la confection de stores.
Coupe à mesure sans coût supplémentaire.

Estor Troya ADHESIVO (Accionamiento Cordón) / ADHESIVE roman blind / ADHESIF store bateau



Blanco
White
Blanc

TROYA ADHESIVO Cordón Conjuntos completos CON VARILLAS / Complete sets WITH LATHS / Kits complets AVEC JONCS * Cintas de confección no incluidas / * Curtain Tapes not included / * Rubans de Rideau non inclus	REF	Soportes Brackets Supports	Correderas Gliders Glisseur					
	D.3075	2	2	10	22,58 €	25,97 €	75	210
D.3100	2	2	10	27,28 €	31,37 €	100	210	

TROYA ADHESIVO Cordón Conjuntos completos SIN VARILLAS / Complete sets WITHOUT LATHS / Kits complets SANS JONCS * Cintas de confección no incluidas / * Curtain Tapes not included / * Rubans de Rideau non inclus	REF	Soportes Brackets Supports	Correderas Gliders Glisseur					
	D.2075	2	2	10	20,24 €	23,28 €	75	210
D.2100	2	2	10	24,18 €	27,81 €	100	210	

Accesorios TROYA / TROYA Accessories / Accessoires TROYA

<p>Riel de Aluminio Velcro (11x23mm) Track With Bonded Velcro / Rail avec Velcro</p>	<table border="1"> <thead> <tr> <th>REF</th> <th></th> <th></th> <th></th> <th></th> <th></th> </tr> </thead> <tbody> <tr> <td>C.12017BL</td> <td></td> <td>60</td> <td>4,74 €/m</td> <td>5,45 €/m</td> <td>600</td> </tr> </tbody> </table>	REF						C.12017BL		60	4,74 €/m	5,45 €/m	600
REF													
C.12017BL		60	4,74 €/m	5,45 €/m	600								
<p>Riel Aluminio Velcro (11x23mm) Track With Bonded (11x23 mm) / Rail avec Bonded Velcro (11x23 mm)</p>	<table border="1"> <thead> <tr> <th>REF</th> <th></th> <th></th> <th></th> <th></th> <th></th> </tr> </thead> <tbody> <tr> <td>C.12008BL</td> <td></td> <td>60</td> <td>6,60 €/m</td> <td>7,59 €/m</td> <td>600</td> </tr> </tbody> </table>	REF						C.12008BL		60	6,60 €/m	7,59 €/m	600
REF													
C.12008BL		60	6,60 €/m	7,59 €/m	600								
<p>Tapa Lateral de Riel Plastic end Cap / Bouchon Final Plastique</p>	<table border="1"> <thead> <tr> <th>REF</th> <th></th> <th></th> <th></th> <th></th> <th></th> </tr> </thead> <tbody> <tr> <td>D.37</td> <td></td> <td>100</td> <td>0,184 €</td> <td>0,221 €</td> <td></td> </tr> </tbody> </table>	REF						D.37		100	0,184 €	0,221 €	
REF													
D.37		100	0,184 €	0,221 €									
<p>Freno Estor Cord Lock / Frein</p>	<table border="1"> <thead> <tr> <th>REF</th> <th></th> <th></th> <th></th> <th></th> <th></th> </tr> </thead> <tbody> <tr> <td>D.33H</td> <td></td> <td>50</td> <td>1,12 €</td> <td>1,34 €</td> <td></td> </tr> </tbody> </table>	REF						D.33H		50	1,12 €	1,34 €	
REF													
D.33H		50	1,12 €	1,34 €									

Accesorios / Accessories / Accessoires

Soporte palanca 20

Brack t /
Support



REF	∅	U	€	€	cm
D.80		50	0,54 €	0,65 €	

Soporte palanca 30

Brack t /
Support



REF	∅	U	€	€	cm
D.81		50	0,72 €	0,83 €	

Soporte 4 cm.

Brack t /
Support



REF	∅	U	€	€	cm
D.39		50	0,70 €	0,84 €	4

* Soporte incluido en el k t / Brack t supplied in the k t / Support fourni dans le k t.

Soporte 3 cm.

Brack t /
Support



REF	∅	U	€	€	cm
D.53		50	0,80 €	0,92 €	3

Soporte techo

Brack t /
Support



REF	∅	U	€	€	cm
D.34		50	0,432 €	0,518 €	3

Soporte 7 cm.

Brack t /
Support



REF	∅	U	€	€	cm
D.35		50	1,00 €	1,20 €	7

Soporte palanca 60

Brack t /
Support)



REF	∅	U	€	€	cm
D.82		50	0,78 €	0,90 €	

Soporte Botón

Button Brack t /
Support Bouton



REF	∅	U	€	€	cm
D.001		100	0,62 €	0,71 €	

Accesorios / Accessories / Accessoires

Freno Mini

Cord Lock /
Petit Frein



REF	∅				
D.78		50	3,00 €	3,45 €	

Corredera de Plástico

Plastic glider /
Glisseur Plastique



REF	∅				
D.999		1000	0,062 €	0,074 €	

Guia Cordón Estor

Cord Guide /
Guide Corde



REF	∅				
D.780		100	0,60 €	0,72 €	

Codo Plástico

Plastic Elbow /
Coude Plastique



REF	∅				
D.31		50	1,52 €	1,82 €	

Rulina Estor

Glider /
Glisseur



REF	∅				
D.36		50	0,56 €	0,67 €	

Empalme

Splice /
Raccordeur



REF	∅				
D.30		50	0,98 €	1,18 €	

Pletinas
Contrapeso

Battens For
Track Blinds /
Contrepoids Pour
Stores Romain

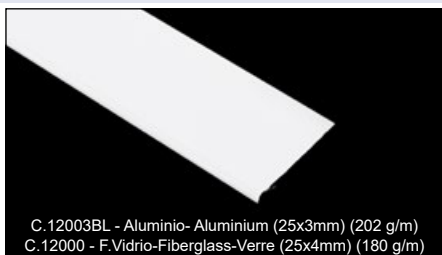

C.12003BL - Aluminio- Aluminium (25x3mm) (202 g/m)
C.12000 - F.Vidrio-Fiberglass-Verre (25x4mm) (180 g/m)

REF	∅				
C.12003BL Alum. (202g/m)		60	4,44 €/m	5,11 €/m	600
C.12000 F.Vidrio (180g/m)		60	3,34 €/m	3,84 €/m	600

Pletinas Contrapeso
Metacrilato Transp.
(27x5mm)

Transparent Acrylic
Batten (27x5mm) /
Contrepond Metacrylate
Transparente
(27x5mm)

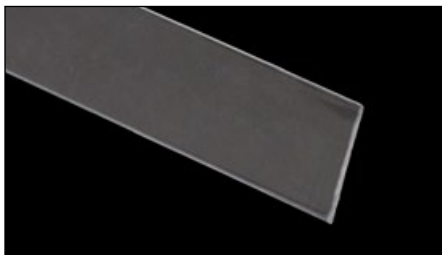

REF	∅				
C.12022TR4000 (161grs/m)		40	7,20 €/m	8,28 €/m	400

Accesorios / Accessories / Accessoires
Varilla de Fibra de Vidrio

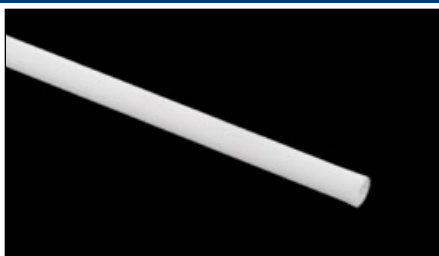
 Fiberglass Lath /
Jonc Fibre de Verre
pour Stores Romain

REF	∅	U	€	€ ¹	cm
D.3600	3 mm	600	0,35 €/m	0,42 €/m	600
D.4600	4 mm	600	0,412 €/m	0,494 €/m	600

Protector de Pletina 3x 5

 Protectie
Batten 3x 5 /
Batón
Protecteur 3x 5

REF	∅	U	€	€ ¹	cm
D.311		500	0,21 €	0,25 €	

Bola Empalme Hilos

 Cord Connector /
Gland Connecteur



REF	∅	U	€	€ ¹	cm
D.15		50	0,72 €	0,86 €	

Bola Empalme Hilos

 Cord Connector /
Gland Connecteur

REF	∅	U	€	€ ¹	cm
D.15LBL		50	2,04 €	2,45 €	

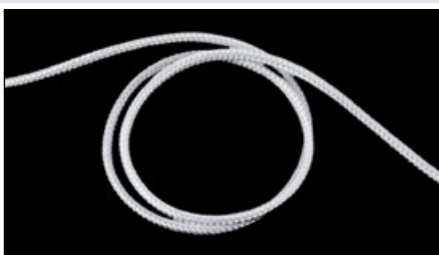
Cordón (Bobina) 1,2 mm

 Cord (Spool) 1,2 mm /
Corde 1,2 mm

REF	∅	U	€	€ ¹	cm
D.09	1,2 mm	500 m		77,16 €	

Cordón Contrapeso

 Lead Weight Tape /
Corde Plombé



REF	∅	U	€	€ ¹	cm
D.51 (22 gr/m)		50 m	0,84 €/m		
D.52 (70 gr/m)		50 m	2,10 €/m		

Cordón (Bobina) 3mm

 Cord (Spool) 3mm /
Corde 3mm

REF	∅	U	€	€ ¹	cm
D.12	3 mm	500 m	67,60 €		

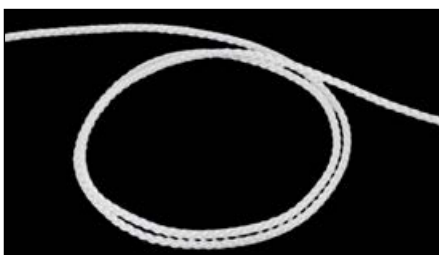
Cordón (Bobina) 1,5mm

 Cord (pool)
1,5mm /
Corde 1,5mm

REF	∅	U	€	€ ¹	cm
D.13	1,5 mm	1000 m	116,40 €		

Accesorios / Accessories / Accessoires

Cinta para Varilla Estor (16mm)		<table border="1"> <thead> <tr> <th>REF</th> <th>COLOR</th> <th></th> <th></th> <th>RAPPORT</th> <th></th> </tr> </thead> <tbody> <tr> <td>D.14</td> <td>blanco/white</td> <td>300 m</td> <td>0,31 €/m</td> <td>-</td> <td>20 mm</td> </tr> </tbody> </table>	REF	COLOR			RAPPORT		D.14	blanco/white	300 m	0,31 €/m	-	20 mm																								
REF	COLOR			RAPPORT																																		
D.14	blanco/white	300 m	0,31 €/m	-	20 mm																																	
Roman Blind Lath Tape / Ruban pour Jonc de Store Bateau	Poliéster 100%																																					
Cinta Cierre-Velcro Hembra 20mm.		<table border="1"> <thead> <tr> <th>REF</th> <th>COLOR</th> <th></th> <th></th> <th>RAPPORT</th> <th></th> </tr> </thead> <tbody> <tr> <td>D.20A (Velour)</td> <td>blanco/white</td> <td>50 m</td> <td>0,60 €/m</td> <td>-</td> <td>20</td> </tr> <tr> <td>D.5 (Astrakan)</td> <td>blanco/white</td> <td>50 m</td> <td>0,41 €/m</td> <td>-</td> <td>20</td> </tr> <tr> <td>D.5AD (Astrakan Adhes.)</td> <td>blanco/white</td> <td>50 m</td> <td>0,92 €/m</td> <td>-</td> <td>20</td> </tr> </tbody> </table>	REF	COLOR			RAPPORT		D.20A (Velour)	blanco/white	50 m	0,60 €/m	-	20	D.5 (Astrakan)	blanco/white	50 m	0,41 €/m	-	20	D.5AD (Astrakan Adhes.)	blanco/white	50 m	0,92 €/m	-	20												
REF	COLOR			RAPPORT																																		
D.20A (Velour)	blanco/white	50 m	0,60 €/m	-	20																																	
D.5 (Astrakan)	blanco/white	50 m	0,41 €/m	-	20																																	
D.5AD (Astrakan Adhes.)	blanco/white	50 m	0,92 €/m	-	20																																	
20 mm Touch&close fastener Tape (Loop section) / Velcro femelle 20mm.	Poliamida 100%																																					
Anilla de Plástico		<table border="1"> <thead> <tr> <th>REF</th> <th></th> <th></th> <th></th> <th></th> <th></th> </tr> </thead> <tbody> <tr> <td>D.32</td> <td></td> <td>1000</td> <td>34,66 €</td> <td></td> <td></td> </tr> </tbody> </table>	REF						D.32		1000	34,66 €																										
REF																																						
D.32		1000	34,66 €																																			
Plastic Rings / Anneau Plastique																																						
Anilla de Plástico (9x13mm)		<table border="1"> <thead> <tr> <th>REF</th> <th></th> <th></th> <th></th> <th></th> <th></th> </tr> </thead> <tbody> <tr> <td>D.38</td> <td></td> <td>1000</td> <td>37,74 €</td> <td></td> <td></td> </tr> </tbody> </table>	REF						D.38		1000	37,74 €																										
REF																																						
D.38		1000	37,74 €																																			
Plastic Rings (9x13mm) / Anneau Plastique (9x13mm)																																						
Anilla de Plástico		<table border="1"> <thead> <tr> <th>REF</th> <th></th> <th></th> <th></th> <th></th> <th></th> </tr> </thead> <tbody> <tr> <td>D.24</td> <td></td> <td>1000</td> <td>34,68 €</td> <td></td> <td></td> </tr> </tbody> </table>	REF						D.24		1000	34,68 €																										
REF																																						
D.24		1000	34,68 €																																			
Plastic Rings / Anneau Plastique																																						
Contrapeso de Madera		<table border="1"> <thead> <tr> <th>REF</th> <th></th> <th></th> <th></th> <th></th> <th></th> </tr> </thead> <tbody> <tr> <td>I.100</td> <td></td> <td>25</td> <td>1,52 €</td> <td>1,75 €</td> <td></td> </tr> </tbody> </table>	REF						I.100		25	1,52 €	1,75 €																									
REF																																						
I.100		25	1,52 €	1,75 €																																		
Wooden Cord Weight / Contrepoids en Bois																																						
Soporte Múltiple de Pared Blanco		<table border="1"> <thead> <tr> <th>REF</th> <th></th> <th></th> <th></th> <th></th> <th></th> </tr> </thead> <tbody> <tr> <td>D.301BL</td> <td></td> <td>25</td> <td>1,98 €</td> <td>2,38 €</td> <td>4</td> </tr> <tr> <td>D.302BL</td> <td></td> <td>25</td> <td>2,08 €</td> <td>2,50 €</td> <td>6</td> </tr> <tr> <td>D.303BL</td> <td></td> <td>25</td> <td>2,36 €</td> <td>2,83 €</td> <td>10</td> </tr> <tr> <td>D.304BL</td> <td></td> <td>25</td> <td>3,00 €</td> <td>3,60 €</td> <td>15</td> </tr> <tr> <td>D.305BL</td> <td></td> <td>25</td> <td>4,78 €</td> <td>5,74 €</td> <td>20</td> </tr> </tbody> </table>	REF						D.301BL		25	1,98 €	2,38 €	4	D.302BL		25	2,08 €	2,50 €	6	D.303BL		25	2,36 €	2,83 €	10	D.304BL		25	3,00 €	3,60 €	15	D.305BL		25	4,78 €	5,74 €	20
REF																																						
D.301BL		25	1,98 €	2,38 €	4																																	
D.302BL		25	2,08 €	2,50 €	6																																	
D.303BL		25	2,36 €	2,83 €	10																																	
D.304BL		25	3,00 €	3,60 €	15																																	
D.305BL		25	4,78 €	5,74 €	20																																	
Whit Wall Extension Bracket / Support Mural Blanc																																						
Soporte Múltiple de Pared Ek rafuerte		<table border="1"> <thead> <tr> <th>REF</th> <th></th> <th></th> <th></th> <th></th> <th></th> </tr> </thead> <tbody> <tr> <td>D.3001BL</td> <td></td> <td>25</td> <td>3,46 €</td> <td>3,98 €</td> <td>7</td> </tr> <tr> <td>D.3002BL</td> <td></td> <td>25</td> <td>4,16 €</td> <td>4,78 €</td> <td>11</td> </tr> <tr> <td>D.3003BL</td> <td></td> <td>25</td> <td>4,94 €</td> <td>5,68 €</td> <td>15</td> </tr> <tr> <td>D.3004BL</td> <td></td> <td>25</td> <td>5,18 €</td> <td>5,96 €</td> <td>19</td> </tr> <tr> <td>D.3005BL</td> <td></td> <td>25</td> <td>5,38 €</td> <td>6,19 €</td> <td>23</td> </tr> </tbody> </table>	REF						D.3001BL		25	3,46 €	3,98 €	7	D.3002BL		25	4,16 €	4,78 €	11	D.3003BL		25	4,94 €	5,68 €	15	D.3004BL		25	5,18 €	5,96 €	19	D.3005BL		25	5,38 €	6,19 €	23
REF																																						
D.3001BL		25	3,46 €	3,98 €	7																																	
D.3002BL		25	4,16 €	4,78 €	11																																	
D.3003BL		25	4,94 €	5,68 €	15																																	
D.3004BL		25	5,18 €	5,96 €	19																																	
D.3005BL		25	5,38 €	6,19 €	23																																	
Wall Ek nsion Bracket (Extrastrong) / Support Mural Ek rafort																																						

Panel Japonés

sliding panels / parois japonaise



 **ALTRAN**[®]
SISTEMAS PARA DECORAR CORTINAS



ALTRAN[®]

CURTAIN DECORATION SYSTEMS

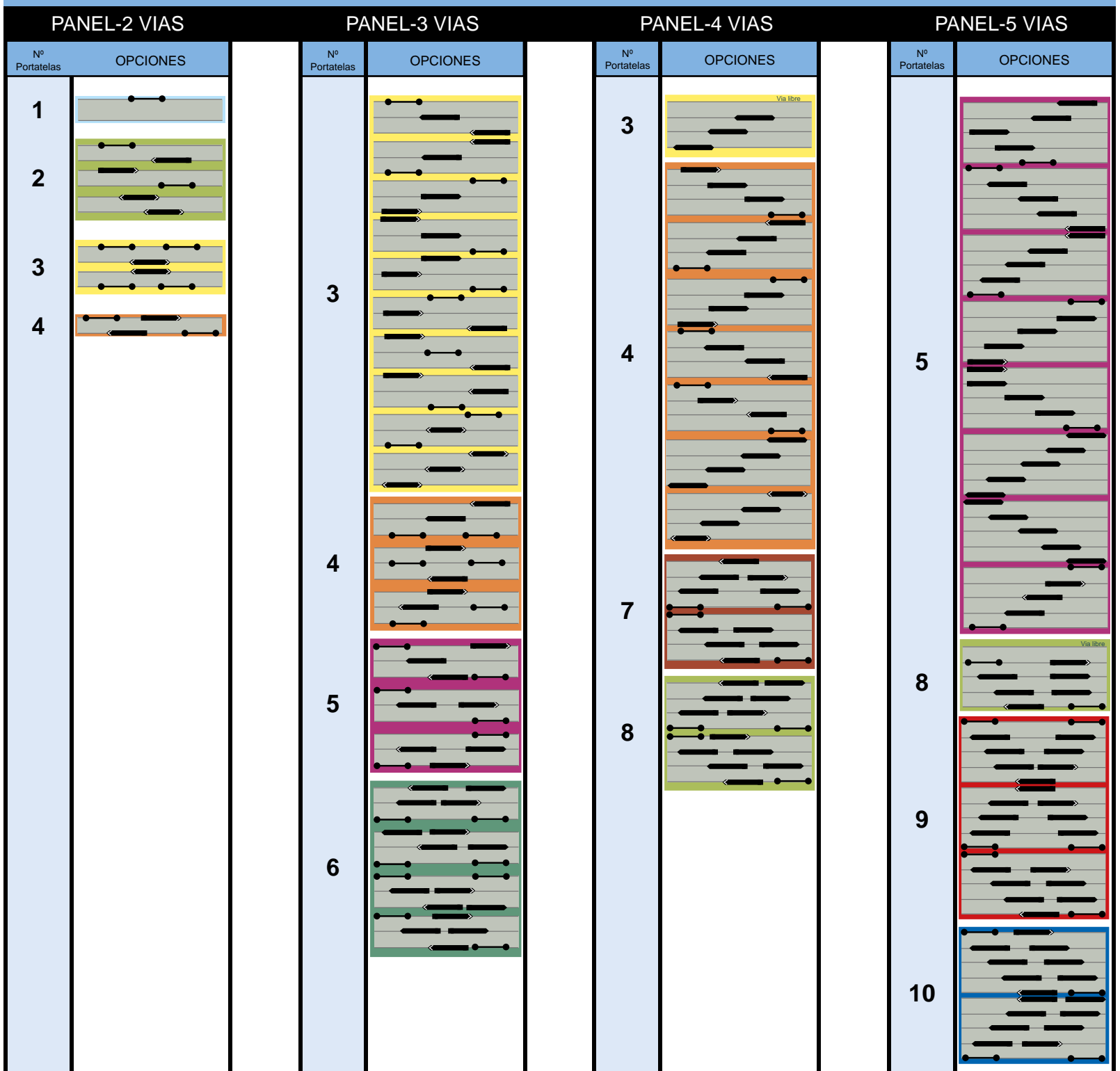

LEYENDA

- Portatela móvil que se desplaza
- hacia la dcha.
 - hacia la izq.
 - hacia dcha e izq.
- Portatelas que arrastra a las otras portatelas móviles
- hacia la dcha.
 - hacia la izq.
 - hacia dcha e izq.
- Fijo
-

LEGEND

- Mobile fabric-holder
- to the right.
 - to the left.
 - right & left.
- Fabric-holder that pulls other fabric holders
- to the right.
 - to the left.
 - right & left.
- Static
-

LEGENDE

- Porte tissu qui se deplace
- vers la droite.
 - vers la gauche.
 - vers droite et gauche.
- Porte tissu qui entraîne les autres porte-tissus
- vers la droite.
 - vers la gauche.
 - vers droite et gauche.
- Porte tissu fixe
-

Panel Japonés 2 VÍAS
Sliding Panel 2 CHANNELS
Parois Japonaise 2 VOIES

Blanco
White
Blanc

Gris
Grey
Gris



Blanco
White/ Blanc

Gris
Grey / Gris

PANEL JAPONÉS 2 VÍAS	Blanco White/ Blanc			Gris Grey / Gris			Soportes Brackets Supports	
	REF	U	€	REF	U	€	cm	
Conjuntos completos / Complete sets / Kits complets * No cobramos incremento para portatela extra o doble mando. / * We do not charge any supplement for double cord or extra fabric-holders. / * Des porte-tissus extra ou double cordes sont fournis sans frais supplémentaires	E.81502	1	45,40 €	E.81502AP	1	49,02 €	2	150
	E.82002	1	60,58 €	E.82002AP	1	65,44 €	2	200
	E.82502	1	71,92 €	E.82502AP	1	77,68 €	3	250
	E.83002	1	82,86 €	E.83002AP	1	89,48 €	3	300
	E.83502	1	95,84 €	E.83502AP	1	103,54 €	3	350
	E.84002	1	107,34 €	E.84002AP	1	119,94 €	4	400
	E.84502	1	119,58 €	E.84502AP	1	133,66 €	4	450
	E.86002	1	156,84 €	E.86002AP	1	172,09 €	6	600

Componentes Panel / Panel Components / Composants Paroi

Componentes panel 2 vías:

Perfil 2 vías Longitud
Terminal 2 vías 1
2 Portatelas Velcros (Longitud/2)+5cm

Componentes comunes:

Pletina Aluminio 40x3 mm Portatelas - 3cm
Correderas Portatelas 4 x portatela
Topes en L 1 x portatela
Topes en T 1 x portatela
Soportes Ver tabla
Cordón 3mm (Longitud x 2)+3m
Unión blocacuerda 1
Tope con Tornillo 1
Cinta Crip hembra Según Portatelas
Contrapeso 1
Protector Pletina 2 x Pletina
Tapas Portatela 2 (1izq.+1der.)
x Nº Portatelas

2 Channels panel Components:

2 Channel Track Length
2 Channel endcap 1
2 Fabric Holder (Length/2)+5cm

Standard common:

40 x 3 mm. Aluminium Batten Fabric Holders-3cm
Fabric-Holder runners 4 x Fabric Holder
L - shaped endstop 1 x Fabric Holder
T - shaped endstop 1 x Fabric Holder
Brackets See table
3mm Cord (Length x 2)+3m
Cord Connector 1
Endstop w/screw 1
Touch&Close fastener tape Subject to fabric Holders
Leadweight 1
Protector Batten 2 x Batten
Fabric-holder end caps 2 (1 left + 1 right) x
Nº of fabric-holders

Components Parois 2 voies:

Rail 2 voies Largeur
Bouchon finale 2 voies 1
2 Rail Velcro (Largeur/2)+5cm

Components:

Pletine Aluminium 40 x 3 mm Rail Velcro-3cm
Galet porteur de tissus 4 x Rail Velcro
Arrêt en L 1 x Rail Velcro
Arrêt en T 1 x Rail Velcro
Supports Voir tableau
Corde 3mm (Langeur x 2)+3m
Connecteur de corde 1
Vis finale 1
Velcro femelle Selon porte-tissus
Tendeur rectangulaire 1
Protecteur Barre de Lestage 2 x Barre
Bouchons pour porte-tissus 2 (1 gau.+1 dro.) x
Nº de porte-tissus

KIT Portatelas Estor

Fabric Holder for
roman Blind /

Porte tissus avec
système de store



REF



D.8001

1

12,60 €

Incremento por KIT de Estor. /
Prices of sets will increase when installing Roman Blind fabric Holders. /
Système Store Bateau avec hausse de prix.

Panel Japonés 3 VÍAS
Sliding Panel 3 CHANNELS
Parois Japonaise 3 VOIES

Blanco
White
Blanc

Gris
Grey
Gris



Blanco
White/ Blanc

Gris
Grey / Gris

PANEL JAPONÉS
3 VÍAS

Conjuntos completos /
Complete sets /
Kits complets

* **No cobramos** incremento
para portatela ek ra o doble
mando. /

* **We do not charge** any
supplement for double cord
or ek ra fabric-holders. /

* Des porte-tissus ek ra ou
double cordes sont fournis
sans frais supplémentaires

REF	U	€
E.81503	1	53,02 €
E.81753	1	60,08 €
E.82003	1	68,80 €
E.82253	1	75,46 €
E.82503	1	83,06 €
E.82753	1	89,40 €
E.83003	1	97,02 €
E.83253	1	107,00 €
E.83503	1	110,40 €
E.84003	1	125,04 €
E.84503	1	137,66 €
E.85003	1	164,82 €
E.86003	1	179,62 €

REF	U	€
E.81503AP	1	57,26 €
E.81753AP	1	64,90 €
E.82003AP	1	74,30 €
E.82253AP	1	81,52 €
E.82503AP	1	89,72 €
E.82753AP	1	96,54 €
E.83003AP	1	104,76 €
E.83253AP	1	115,58 €
E.83503AP	1	119,24 €
E.84003AP	1	135,04 €
E.84503AP	1	148,68 €
E.85003AP	1	178,06 €
E.86003AP	1	193,23 €

Soportes Brack ts Supports	cm
3	150
4	175
4	200
4	225
4	250
4	275
4	300
4	325
5	350
5	400
5	450
6	500
6	600

Componentes Panel / Panel Components / Composants Paroi

Componentes panel 3 vías:

Perfil 3 vías Longitud
Terminal 3 vías 1
3 Portatelas Velcrados (Longitud/3)+5cm

Componentes comunes:

Pletina Aluminio 40& mm Portatelas - 3cm
Correderas Portatelas 4 x portatela
Topes en L 1 x portatela
Topes en T 1 x portatela
Soportes Ver tabla
Cordón 3mm (Longitud x 2)+3m
Unión blocacuerda 1
Tope con Tornillo 1
Cinta Crip hembra Según Portatelas
Contrapeso 1
Protector Pletina 2 x Pletina
Tapas Portatela..... 2 (1izq.+1der.)
x Nº Portatelas

3 Channels panel Components:

3 Channel TrackLength
3 Channel endcap.....1
3 Fabric Holder.....(Length/3)+5cm

Standard common:

40 x 3 mm. Aluminium Batten..... Fabric Holders-3cm
Fabric-Holder runners..... 4 x Fabric Holder
L - shaped endstop..... 1 x Fabric Holder
T - shaped endstop..... 1 x Fabric Holder
Brack ts..... See table
3mm Cord..... (Length x 2)+3m
Cord Connector.....1
Endstop w/screw.....1
Touch&Close fastener tape..... Subject to fabric Holders
Leadweight..... 1
Protector Batten..... 2 x Batten
Fabric-holder end caps 2 (1 left + 1 right) x
Nº of fabric-holders

Components Parois 3 voies:

Rail 3 voies.....Largeur
Bouchon finale 3 voies.....1
3 Rail Velcro.....(Largeur/3)+5cm

Components:

Pletine Aluminium 40 x 3 mm..... Rail Velcro-3cm
Galet porteur de tissus..... 4 x Rail Velcro
Arrêt en L..... 1 x Rail Velcro
Arrêt en T..... 1 x Rail Velcro
Supports..... Voir tableau
Corde 3mm..... (Langeur x 2)+3m
Connecteur de corde..... 1
Vis finale..... 1
Velcro femelle..... Selon porte-tissus
Tendeur rectangulaire..... 1
Protecteur Barre de Lestage..... 2 x Barre
Bouchons pour porte-tissus 2 (1 gau.+1 dro.) x
Nº de porte-tissus

KIT Portatelas Estor

Fabric Holder for
roman Blind /

Porte tissus avec
système de store



REF	U	€
D.8001	1	12,60 €

Incremento por KIT de Estor. /
Prices of sets will increase when installing Roman Blind fabric Holders. /
Syt éme Stor Bateau aæ c hausse de prix

Panel Japonés 4 VÍAS
Sliding Panel 4 CHANNELS
Parois Japonaise 4 VOIES

Blanco
White
Blanc

Gris
Grey
Gris

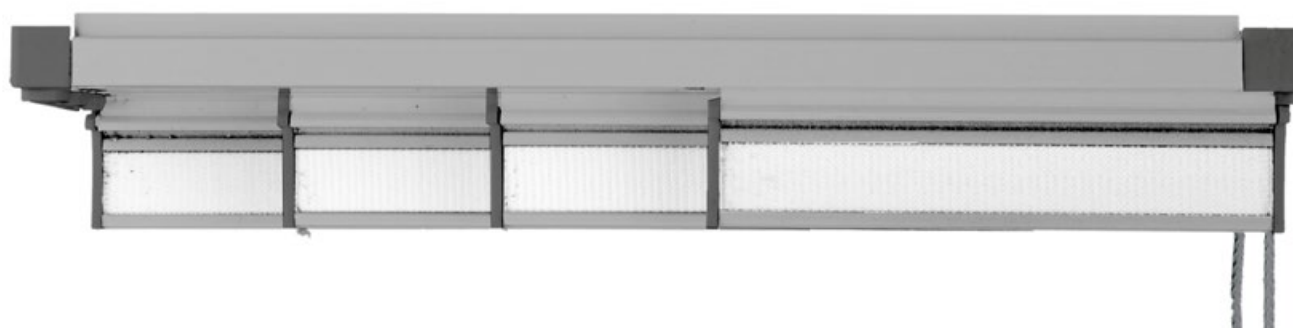

Blanco
White/ Blanc

Gris
Grey / Gris

PANEL JAPONÉS 4 VÍAS

Conjuntos completos /
Complete sets /
Kits complets

* **No cobramos** incremento
para portatela ek ra o doble
mando. /

* **We do not charge** any
supplement for double cord
or ek ra fabric-holders. /

* Des porte-tissus ek ra ou
double cordes sont fournis
sans frais supplémentaires

REF	U	€
E.81504	1	60,96 €
E.81754	1	68,96 €
E.82004	1	78,20 €
E.82254	1	86,34 €
E.82504	1	93,54 €
E.82754	1	102,00 €
E.83004	1	109,18 €
E.83254	1	117,16 €
E.83504	1	124,34 €
E.84004	1	140,92 €
E.84504	1	155,28 €
E.85004	1	187,86 €
E.86004	1	202,68 €

REF	U	€
E.81504AP	1	65,84 €
E.81754AP	1	74,48 €
E.82004AP	1	84,50 €
E.82254AP	1	93,26 €
E.82504AP	1	101,00 €
E.82754AP	1	110,18 €
E.83004AP	1	117,88 €
E.83254AP	1	126,56 €
E.83504AP	1	134,26 €
E.84004AP	1	152,20 €
E.84504AP	1	167,70 €
E.85004AP	1	202,88 €
E.86004AP	1	218,88 €

Soportes Brack ts Supports	cm
3	150
4	175
4	200
4	225
4	250
4	275
4	300
4	325
5	350
5	400
5	450
6	500
6	600

Componentes Panel / Panel Components / Composants Paroi

Componentes panel 4 v as:

Perfil 4 vías Longitud
Terminal 4 v as 1
4 Portatelas Velcrados (Longitud/4)+5cm

Componentes comunes:

Pletina Aluminio 40x3 mm Portatelas - 3cm
Correderas Portatelas 4 x portatela
Topes en L 1 x portatela
Topes en T 1 x portatela
Soportes Ver tabla
Cordón 3mm (Longitud x 2)+3m
Unión blocacuerda 1
Tope con Tornillo 1
Cinta Crip hembra Según Portatelas
Contrapeso 1
Protector Pletina 2 x Pletina
Tapas Portatela 2 (1izq.+1der.)
x Nº Portatelas

4 Channels panel Components:

4 Channel Track Length
4 Channel endcap 1
4 Fabric Holder (Length/4)+5cm

Standard common:

40 x 3 mm. Aluminium Batten Fabric Holders-3cm
Fabric-Holder runners 4 x Fabric Holder
L - shaped endstop 1 x Fabric Holder
T - shaped endstop 1 x Fabric Holder
Brack ts See table
3mm Cord (Length x 2)+3m
Cord Connector 1
Endstop w/screw 1
Touch&Close fastener tape Subject to fabric Holders
Leadweight 1
Protector Batten 2 x Batten
Fabric-holder end caps 2 (1 left + 1 right) x
Nº of fabric-holders

Componentes Parois 4 v oies:

Rail 4 v oies Largeur
Bouchon finale 4 voies 1
4 Rail Velcro (Largeur/4)+5cm

Components:

Pletine Aluminium 40 x 3 mm Rail Velcro-3cm
Galet porteur de tissus 4 x Rail Velcro
Arrêt en L 1 x Rail Velcro
Arrêt en T 1 x Rail Velcro
Supports Voir tableau
Corde 3mm (Langeur x 2)+3m
Connecteur de corde 1
Vis finale 1
Velcro femelle Selon porte-tissus
Tendeur rectangulaire 1
Protecteur Barre de Lestage 2 x Barre
Bouchons pour porte-tissus 2 (1 gau.+1 dro.) x
Nº de porte-tissus

KIT Portatelas Estor

Fabric Holder for
roman Blind /

Porte tissus avec
système de store



REF	U	€
D.8001	1	12,60 €

Incremento por KIT de Estor. /
Prices of sets will increase when installing Roman Blind fabric Holders. /
Système Stor Bateau avec hausse de prix.

Panel Japonés 5 VÍAS
Sliding Panel 5 CHANNELS
Parois Japonaise 5 VOIES



Blanco
White/ Blanc

Gris
Grey / Gris

PANEL JAPONÉS
5 VÍAS

Conjuntos completos /
Complete sets /
Kits complets

* **No cobramos** incremento para portatela extra o doble mando. /

* **We do not charge** any supplement for double cord or extra fabric-holders. /

* Des porte-tissus extra ou double cordes sont fournis sans frais supplémentaires

REF	U	€
E.81505	1	68,50 €
E.81755	1	77,32 €
E.82005	1	85,70 €
E.82255	1	95,36 €
E.82505	1	104,48 €
E.82755	1	112,46 €
E.83005	1	120,44 €
E.83255	1	130,50 €
E.83505	1	138,46 €
E.84005	1	155,56 €
E.84505	1	172,80 €
E.85005	1	210,46 €
E.86005	1	223,90 €

REF	U	€
E.81505AP	1	73,98 €
E.81755AP	1	83,26 €
E.82005AP	1	92,54 €
E.82255AP	1	104,22 €
E.82505AP	1	108,84 €
E.82755AP	1	121,44 €
E.83005AP	1	130,08 €
E.83255AP	1	140,94 €
E.83505AP	1	149,52 €
E.84005AP	1	168,44 €
E.84505AP	1	186,64 €
E.85005AP	1	227,32 €
E.86005AP	1	241,80 €

Soportes Brackets Supports	cm
3	150
4	175
4	200
4	225
4	250
4	275
4	300
4	325
5	350
5	400
5	450
6	500
6	600

Componentes Panel / Panel Components / Composants Paroi

Componentes panel 5 vías:

Perfil 5 vías	Longitud
Terminal 5 vías	1
5 Portatelas Velcrados	(Longitud/5)+5cm

Componentes comunes:

Pletina Aluminio 40x3 mm	Portatelas - 3cm
Correderas Portatelas	4 x portatela
Topes en L	1 x portatela
Topes en T	1 x portatela
Soportes	Ver tabla
Cordón 3mm	(Longitud x 2)+3m
Unión blocacuerda	1
Tope con Tornillo	1
Cinta Crip hembra	Según Portatelas
Contrapeso	1
Protector Pletina	2 x Pletina
Tapas Portatela.....	2 (1izq.+1der.) x Nº Portatelas

5 Channels panel Components:

5 Channel Track	Length
5 Channel endcap.....	1
5 Fabric Holder.....	(Length/5)+5cm

Standard common:

40 x 3 mm. Aluminium Batten.....	Fabric Holders-3cm
Fabric-Holder runners.....	4 x Fabric Holder
L - shaped endstop.....	1 x Fabric Holder
T - shaped endstop.....	1 x Fabric Holder
Brackets.....	See table
3mm Cord.....	(Length x 2)+3m
Cord Connector.....	1
Endstop w/screw.....	1
Touch&Close fastener tape.....	Subject to fabric Holders
Leadweight.....	1
Protector Batten.....	2 x Batten
Fabric-holder end caps	2 (1 left + 1 right) x Nº of fabric-holders

Componentes Parois 5 voies:

Rail 5 vías.....	Largeur
Bouchon finale 5 voies.....	1
5 Rail Velcro.....	(Largeur/5)+5cm

Components:

Pletine Aluminium 40 x 3 mm.....	Rail Velcro-3cm
Galet porteur de tissus.....	4 x Rail Velcro
Arrêt en L.....	1 x Rail Velcro
Arrêt en T.....	1 x Rail Velcro
Supports.....	Voir tableau
Corde 3mm.....	(Langeur x 2)+3m
Connecteur de corde.....	1
Vis finale.....	1
Velcro femelle.....	Selon porte-tissus
Tendeur rectangulaire.....	1
Protecteur Barre de Lestage.....	2 x Barre
Bouchons pour porte-tissus	2 (1 gau.+1 dro.) x Nº de porte-tissus

KIT Portatelas Estor

Fabric Holder for
roman Blind /

Porte tissus avec
système de store

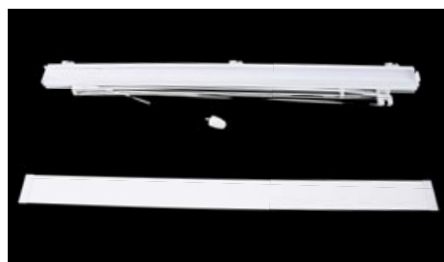

REF	U	€
D.8001	1	12,60 €

Incremento por KIT de Estor. /
Prices of sets will increase when installing Roman Blind fabric Holders. /
Système Stor Bateau avec hausse de prix



Perfil de Aluminio 2 vías (38x20mm)

2 Channel Aluminium Track / Rail Aluminium 2 vías

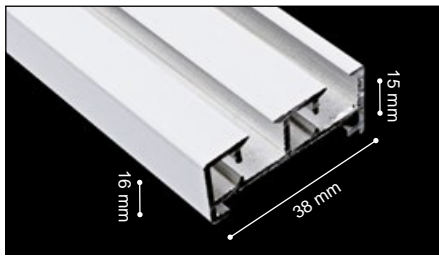

REF	∅				
C.120142BL1500		10	13,20 €	15,18 €	150
C.120142BL2000		10	17,60 €	20,24 €	200
C.120142BL2500		10	22,00 €	25,30 €	250
C.120142BL3000		10	26,40 €	30,36 €	300
C.120142BL3500		10	30,80 €	35,42 €	350
C.120142BL6000		10	52,80 €	60,72 €	600
C.120142AP6000		10	58,40 €	67,16 €	600

Perfil de Aluminio 3 vías (57x20mm)

3 Channel Aluminium Track / Rail Aluminium 3 vías

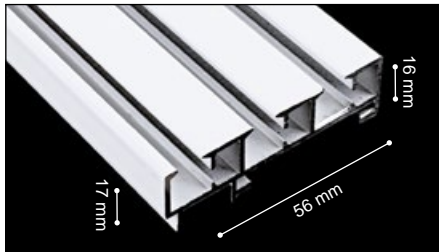

REF	∅				
C.120143BL1500		10	18,54 €	21,32 €	150
C.120143BL1750		10	21,62 €	24,86 €	175
C.120143BL2000		10	24,72 €	28,43 €	200
C.120143BL2250		10	27,80 €	31,97 €	225
C.120143BL2500		10	30,90 €	35,54 €	250
C.120143BL2750		10	33,98 €	39,08 €	275
C.120143BL3000		10	37,08 €	42,64 €	300
C.120143BL3250		10	40,16 €	46,18 €	325
C.120143BL3500		10	43,26 €	49,75 €	350
C.120143BL4000		10	49,44 €	56,86 €	400
C.120143BL4500		10	55,62 €	63,96 €	450
C.120143BL5000		10	61,80 €	71,07 €	500
C.120143BL6000		10	74,16 €	85,28 €	600
C.120143AP6000		10	80,86 €	92,99 €	600

Perfil de Aluminio 4 vías (73x20mm)

4 Channel Aluminium Track / Rail Aluminium 4 vías

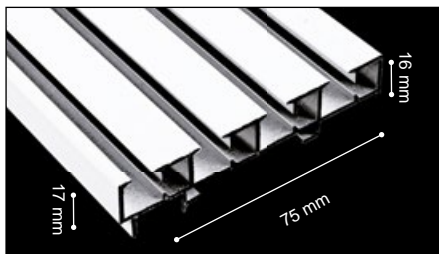

REF	∅				
C.120144BL1500		10	24,02 €	27,62 €	150
C.120144BL1750		10	28,04 €	32,25 €	175
C.120144BL2000		10	32,04 €	36,85 €	200
C.120144BL2250		10	36,04 €	41,45 €	225
C.120144BL2500		10	40,04 €	46,05 €	250
C.120144BL2750		10	44,04 €	50,65 €	275
C.120144BL3000		10	48,06 €	55,27 €	300
C.120144BL3250		10	52,06 €	59,87 €	325
C.120144BL3500		10	56,06 €	64,47 €	350
C.120144BL4000		10	64,08 €	73,69 €	400
C.120144BL4500		10	72,08 €	82,89 €	450
C.120144BL5000		10	80,10 €	92,12 €	500
C.120144BL6000		10	96,12 €	110,54 €	600
C.120144AP6000		10	105,84 €	121,72 €	600

Accesorios / Accessories / Accessoires



Perfil de Aluminio 5 vías (73x20mm)

5 Channel Aluminium Track / Rail Aluminium 5 vías

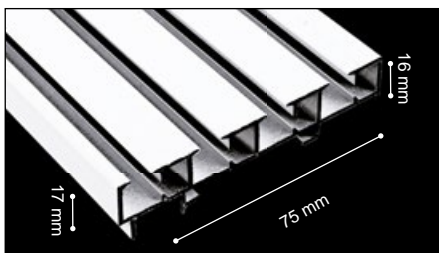

REF	∅	U	€	€	cm
C.120145BL1500		10	29,06 €	33,42 €	150
C.120145BL1750		10	33,90 €	38,99 €	175
C.120145BL2000		10	38,76 €	44,57 €	200
C.120145BL2250		10	43,60 €	50,14 €	225
C.120145BL2500		10	48,44 €	55,71 €	250
C.120145BL2750		10	53,28 €	61,27 €	275
C.120145BL3000		10	58,14 €	66,86 €	300
C.120145BL3250		10	62,98 €	72,43 €	325
C.120145BL3500		10	67,82 €	77,99 €	350
C.120145BL4000		10	77,52 €	89,15 €	400
C.120145BL4500		10	87,20 €	100,28 €	450
C.120145BL5000		10	96,90 €	111,44 €	500
C.120145BL6000		10	116,28 €	133,72 €	600
C.120145AP6000		10	127,98 €	147,18 €	600

Juego Tapas (der+izq) 2 vías

Endcaps set (right+left) 2 Channel / Pair bouchons (droite+gauche) 2 vías



REF	∅	U	€	€	cm
D.912		50	1,66 €	1,91 €	
D.912GR		50	1,84 €	2,12 €	

Juego Tapas (der+izq) 3 vías

Endcaps set (right+left) 3 Channel / Pair bouchons (droite+gauche) 3 vías



REF	∅	U	€	€	cm
D.913		50	1,74 €	2,00 €	
D.913GR		50	1,92 €	2,21 €	

Juego Tapas (der+izq) 4 vías

Endcaps set (right+left) 4 Channel / Pair bouchons (droite+gauche) 4 vías



REF	∅	U	€	€	cm
D.914		50	1,94 €	2,23 €	
D.914GR		50	2,14 €	2,46 €	

Juego Tapas (der+izq) 5 vías

Endcaps set (right+left) 5 Channel / Pair bouchons (droite+gauche) 5 vías



REF	∅	U	€	€	cm
D.915		50	2,08 €	2,39 €	
D.915GR		50	2,26 €	2,60 €	

Juego Tapas Terminales (der+izq) 2-3-4-5 vías

Endcap pair 2-3-4-5 channels (Right+Left) / Jeux bouchon 2-3-4-5 vías

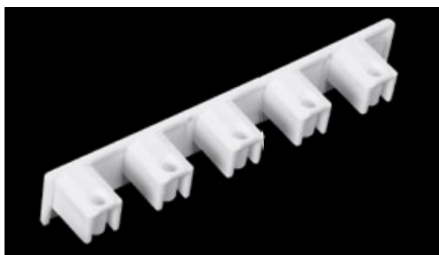

REF	∅	U	€	€	cm
D.917		50	2,88 €	3,31 €	



Perfil Portateles de Aluminio

Aluminium
Fabric Holder /
Porte-tissu



REF	∅				
C.12009BL		60 m	7,44 €/m	8,56 €/m	600

Perfil Portateles de Aluminio Velcro

Fabric Holder /
Rail Aluminium Velcro



REF	∅				
C.12002BL		60 m	5,50 €/m	6,33 €/m	600
C.12002AP		60 m	6,14 €/m	7,06 €/m	600

Pletina Aluminio 408 mm.

408 mm.
Aluminium Batten /
Bâton Aluminium
408 mm.

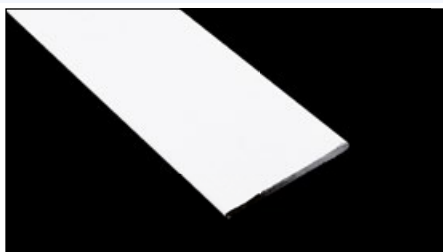

REF	∅				
C.12001BL (319g)		60 m	6,14 €/m	7,06 €/m	600

Pletina Contrapeso Metacrilato Transp. (40x5mm)

Transparent acrylic
Batten (40x5mm) /
Barre de metacrylate
transparente (40x5mm)



REF	∅				
C.12023TR4000 (236g)		40	9,60 €/m	11,04 €/m	400

Cinta Velcro Hembra Velour 20 mm

Touch&Close Fastener
Tape (Loop Section) /
Velcro femelle

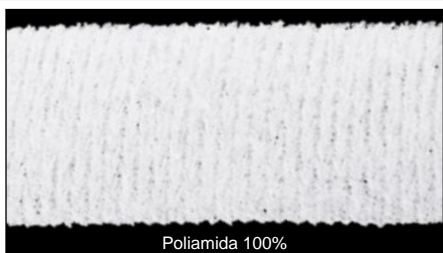

REF	COLOR	rollo (m) roll (m)		RAPPORT	
D.20A (Velour)	blanco/white	50 m	0,60 €/m	-	20 mm
D.5 (Astrakan)	blanco/white	50 m	0,41 €/m	-	20 mm
D.5AD (Astrakan Adhes.)	blanco/white	50 m	0,92 €/m	-	20 mm

Rollo 200m. de Cordón 3mm.

Roll of 200m. of 3mm
cord /
200m. corde 3mm.

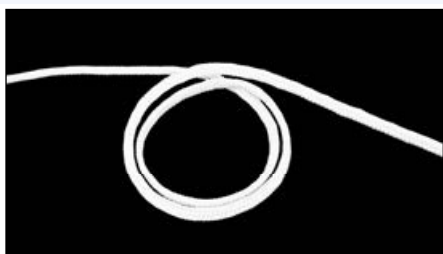

REF	∅				
D.035		1	55,86 €		
D.035GR		1	61,42 €		

Rollo 500m. de Cordón 2,7mm.

Roll of 500m. of
2,7mm /
500m. corde
2,7mm.

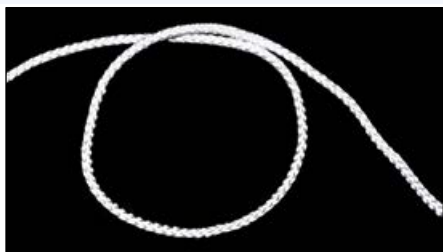

REF	∅				
D.12P		1	116,40 €		

Unión Blocacuerda

Cord Connector/
Connecteur
pour corde



REF	∅				
D.96		100	0,78 €	0,94 €	
D.96GR		100	0,78 €	0,94 €	



Tope L

L-shaped Enstop / Arrêt en L



REF	∅	U	€	€	cm
D.94		100	0,43 €	0,52 €	
D.94GR		100	0,472 €	0,566 €	

Tope T

T-shaped Enstop / Arrêt en T



REF	∅	U	€	€	cm
D.95		100	0,43 €	0,52 €	
D.95GR		100	0,472 €	0,566 €	

Correderas Portatelas

Fabric-Holder Runner / Glisseur Porteur de Tissus



REF	∅	U	€	€	cm
D.92		100	0,33 €	0,40 €	
D.92GR		100	0,37 €	0,44 €	

Tope con Tornillo

Endstop w/screw / Vis finale



REF	∅	U	€	€	cm
D.97		100	0,35 €	0,42 €	
D.97GR		100	0,37 €	0,44 €	

Soporte 2/3 v as

Bracket 2/3 channel / Support 2/3 v ies



REF	∅	U	€	€	cm
D.983		100	0,78 €	0,94 €	
D.983GR		100	0,80 €	0,96 €	

* Soporte incluido en el kit / Bracket supplied in the kit / Support fourni dans le kit.

Soporte 4/5 v as

Bracket 4/5 channel / Support 4/5 v ies



REF	∅	U	€	€	cm
D.9845		100	0,82 €	0,98 €	
D.9845GR		100	0,84 €	1,01 €	

* Soporte incluido en el kit / Bracket supplied in the kit / Support fourni dans le kit.

Protector de Pletina 3x0

Protector Batten 3x0 / Protecteur Barre de lestage 3x0



REF	∅	U	€	€	cm
D.310		500	0,266 €	0,319 €	

Tapa Portatela Derecha (D), Izquierda (I)

Right (D), Left (I) End-cap Fabric Holders / Bouchon Porte-Tissus droite(D), Gauche (I)



REF	∅	U	€	€	cm
D.99D		100	0,35 €	0,42 €	
D.99I		100	0,35 €	0,42 €	
D.99GRD		100	0,39 €	0,47 €	
D.99GRI		100	0,39 €	0,47 €	



Adaptador Tirador

Clip /
Adapteur
Lance Rideau



REF	∅				
D.98		50	1,28 €	1,54 €	

Soporte 2/3 v as

Brack t 2/3 channel /
Support 2/3 v as



REF	∅				
D.933		50	1,38 €	1,66 €	

Soporte 4/5 v as

Brack t 4/5 channel /
Support 4/5 v as



REF	∅				
D.9345		50	1,50 €	1,80 €	

Empalme

Splice /
raccordeur



REF	∅				
D.91		10	3,28 €	3,77 €	

Tirador

Wand /
Lance rideau



REF	∅				
L.11		25	2,08 €	2,39 €	100
L.11150		25	3,22 €	3,70 €	150

Tirador Metacrilato

Methacry late Wand /
Lance Rideau
Méthacry late



REF	∅				
L.12		1		18,22 €	100

Contrapeso Cordón

Cordweight /
Contrepoids cordon



REF	∅				
I.1150		25	1,52 €	1,82 €	

Contrapeso Cordón

Cordweight /
Contrepoids cordon

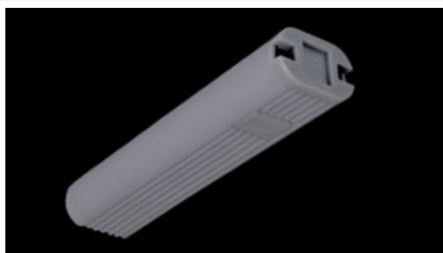

REF	∅				
I.1150GR		25	1,70 €	2,04 €	

Accesorios / Accessories / Accessoires



SopORTE Múltiple de Pared Blanco
 White Wall Ek ension Bracket / Support Mural Blanc



REF	∅	U	€	€ ¹	cm
D.301BL		25	1,98 €	2,38 €	4
D.302BL		25	2,08 €	2,50 €	6
D.303BL		25	2,36 €	2,83 €	10
D.304BL		25	3,00 €	3,60 €	15
D.305BL		25	4,78 €	5,74 €	20

SopORTE Múltiple de Pared Ek rafuerte
 Wall Ek ension Bracket (Extrastrong) / Support Mural Ek rafort



REF	∅	U	€	€ ¹	cm
D.3001BL		25	3,46 €	3,98 €	7
D.3002BL		25	4,16 €	4,78 €	11
D.3003BL		25	4,94 €	5,68 €	15
D.3004BL		25	5,18 €	5,96 €	19
D.3005BL		25	5,38 €	6,19 €	23

Galeria 7 cm.
 Pelmet 7cm. / Cantonnière 7cm.



REF	∅	U	€	€ ¹	cm
C.12013BL		60 m	6,50 €	7,48 €	
C.12013		60 m	6,94 €	7,98 €	

Muestra Panel Japonés Blanco
 Demo Sample white Sliding Panel / Échantillon Paroi Japonise Blanc



REF	∅	U	€	€ ¹	cm
M.4		1		20,24 €	

Muestra Panel Japonés Blanco
 Demo Sample Grey Sliding Panel / Échantillon Paroi Japonise Grey

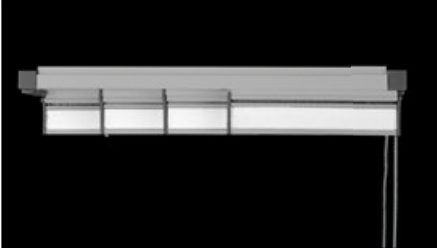

REF	∅	U	€	€ ¹	cm
M.4AP		1		22,48 €	

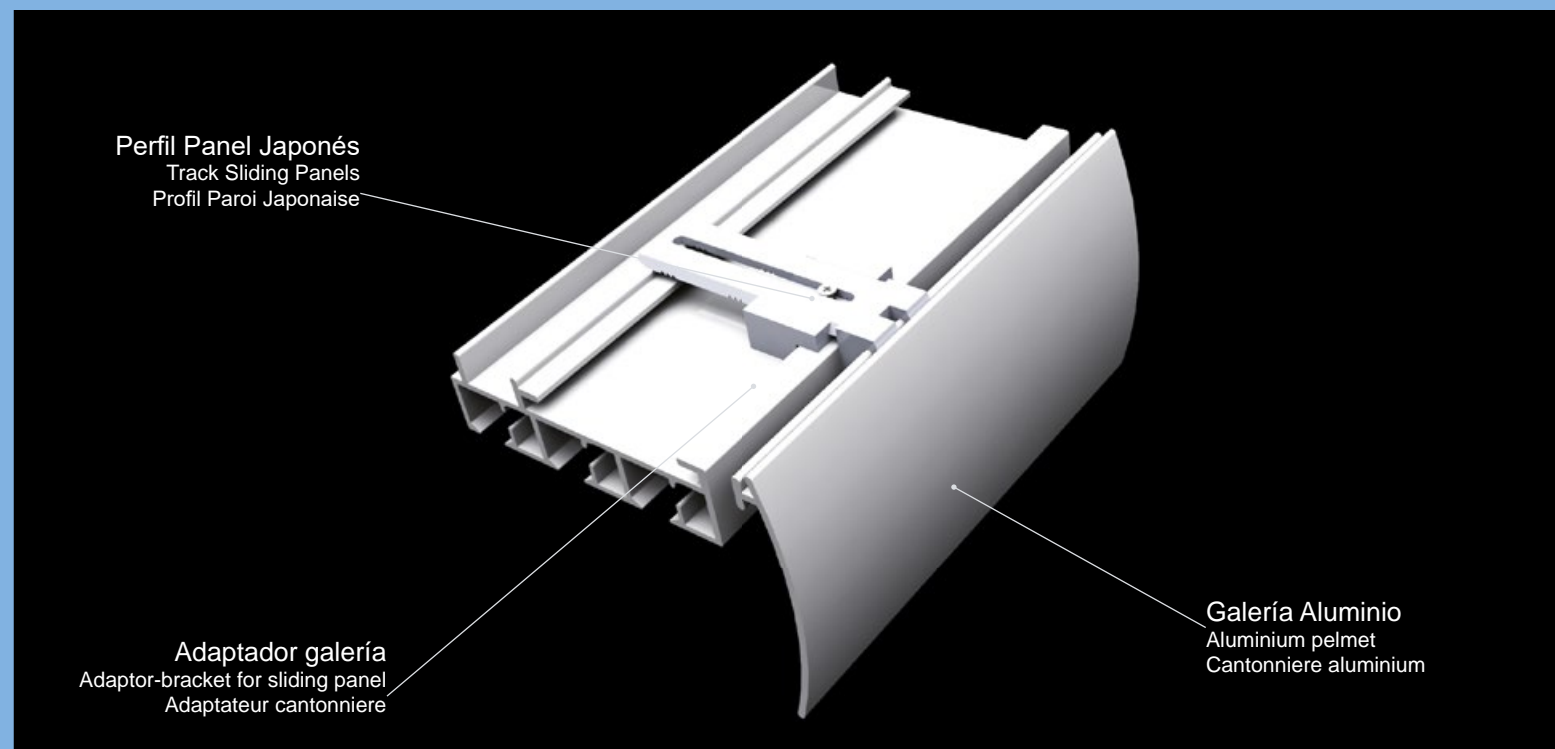

Galería Aluminio
Anodizado



Anodized Aluminium
Pelmet /
Cantonnière
Aluminium Anodisé

REF					
C.1203552AP	60	5,40 €/m	6,21€/m	52	600
C.1203580AP	60	8,14 €/m	9,36 €/m	80	600

Galería Aluminio
Blanca



White Aluminium
Pelmet /
Cantonnière
Aluminium Blanc

REF					
C.1203552BL	60	4,96 €/m	5,70 €/m	52	600
C.1203580BL	60	7,34 €/m	8,44 €/m	80	600

Adaptador Galería
Panel Japonés



Adaptor-bracket for
Sliding Panel /
Adaptateur
Cantonnière
Paroi Japonaise

REF					
D.90		50	1,16 €	1,33 €	

* El adaptador sirve para todos los perfiles desde 2 hasta 5 vías.
The adaptor-bracket can be used on all sliding-panel rails.
L'adaptateur peut être utilisé avec tous les profils de 2 a 5 voies.

Panel Japonés Codo

Elbow /
Coude



REF					
D.2033BL		20	1,16 €	1,33 €	

* Sólo disponible para la galería de 8 cm.
Only available for 8 cm pelmet / Seulement disponible pour cantonnière 8 cm.

Panel Japonés Codo

Elbow /
Coude



REF					
D.2033GR		20	1,16 €	1,33 €	

* Sólo disponible para la galería de 8 cm.
Only available for 8 cm pelmet / Seulement disponible pour cantonnière 8 cm.

CODIGO CLIENTE..... NOMBRE CLIENTE.....

FECHA PEDIDO..... POBLACION.....

OBSERVACIONES.....

REFERENCIA	CANTIDAD	MEDIDA PANEL	Nº Vías	Nº TOTAL PORTATELAS	MEDIDA(2) PORTATELAS	PORTATELAS EXTRA			CROQUIS DEL PANEL	¿MOTOR?
						POSICIÓN PORTATELA FIJO	POSICIÓN CUERDA	ALtura CUERDA(2)		
						DERECHA IZQUIERDA CENTRAL	DERECHA IZQUIERDA	SISTEMA NORMAL 11.8000	DERECHA IZQUIERDA	
						DERECHA IZQUIERDA CENTRAL	DERECHA IZQUIERDA		DERECHA IZQUIERDA	
						DERECHA IZQUIERDA CENTRAL	DERECHA IZQUIERDA		DERECHA IZQUIERDA	
						DERECHA IZQUIERDA CENTRAL	DERECHA IZQUIERDA		DERECHA IZQUIERDA	
						DERECHA IZQUIERDA CENTRAL	DERECHA IZQUIERDA		DERECHA IZQUIERDA	

(1) DEBE AÑADIRSE EN EL PEDIDO EL RESULTADO DE ESTAS CASILLAS CON SUS CÓDIGOS CORRESPONDIENTES.

(2) RELLENAR SÓLO SI EL CLIENTE LO ESPECIFICA

NOTA: EL STANDARD DE MONTAJE DE PANEL ES EL SIGUIENTE:

SISTEMA DE CUERDA (1,5M)

SISTEMA DE INSTALACIÓN TRASERO

PORTATELAS FIJO EN POSICIÓN DELANTERA

MEDIDA PORTATELAS=(MEDIDA PANEL/NºPORTATELAS)+5CM

SIMBOLOGÍA



CUSTOMER N° / CODE CLIENT..... CUSTOMER NAME / NOM CLIENT.....

ORDER DATE / DATE COMMANDE..... ADDRESS / VILLE.....

REMARKS / OBSERVATIONS.....

REFERENCE / RÉFÉRENCE	QUANTITY / QUANTITÉ	PANEL WIDTH / MESURE PANNEAU	N° CHANNELS / N° VOIES	TOTAL N° OF FABRIC-HOLDERS / N° TOTAL PORTE-TISSUS	FABRIC-HOLDERS WIDTH (2) / MESURE(2) PORTE-TISSUS	FABRIC-HOLDER / POSITION PORTE-TISSUS FIXE			CORD POSITION(1) / POSITION CORDE (1)			CORD HEIGHT / HAUTEUR CORDE			EXTRA F-HOLDER / P-TISSUS EXTRA(1)		SKETCH OF PANEL / DESSIN DU PANNEAU	MOTOR / MOTEUR			
						RIGHT / DROITE	LEFT / GAUCHE	CENTER CENTRE	RIGHT / DROITE	LEFT / GAUCHE	CENTER CENTRE	RIGHT / DROITE	LEFT / GAUCHE	CENTER CENTRE	RIGHT / DROITE	LEFT / GAUCHE			CENTER CENTRE	NORMAL SYSTEM/ SYSTÈME NORMAL 11.8000	BLIND SYSTEM/ SYSTÈME STORE 11.8001

(1) ORDER MUST INCLUDE REF. NUMBERS OF ALL FILLED-IN COLUMNS / EN CAS DE COMMANDE DE SYSTÈME STORE, LE RAJOUTER DANS LA COMMANDE.

(2) TO BE FILLED IN ONLY WHEN REQUIRED BY CUSTOMER / REMPLIR SEULEMENT SI LE CLIENT LE SPÉCIFIE.

NOTE / NOTE: STANDAR ASSEMBLY IS AS FOLLOWS: / LE STANDARD DU MONTAGE EST LE SUIVANT.

REVERSE SIDE INSTALLATION SYSTEM / SYSTÈME D'INSTALLATION ARRIÈRE

STATIC FABRIC-HOLDER IN FRONT POSITION / PORTE-TISSUS FIXE EN POSITION PREMIERE.

FABRIC-HOLDER WIDTH= (PANEL WIDTH / N° OF FABRIC-HOLDERS + 5CMS / MESURE PORTE-TISSUS= (MESURE PANNEAU / N° PORTE-TISSUS) + 5CMS.



PANEL-3 VIAS		PANEL-4 VIAS		PANEL-5 VIAS	
Nº Portatelas	OPCIONES	Nº Portatelas	OPCIONES	Nº Portatelas	OPCIONES
3		4		5	
		8			
4		9			
6					
		10			

LEYENDA

<u>Portatela móvil que se desplaza</u>	
	hacia la dcha.
	hacia la izq.
	hacia dcha e izq.
<u>Portatelas que arrastra a las otras portatelas móviles</u>	
	hacia la dcha.
	hacia la izq.
	hacia dcha e izq.
<u>Fijo</u>	

LEGEND

<u>Mobile fabric-holder</u>	
	to the right.
	to the left.
	right & left.
<u>Fabric-holder that pulls other fabric holders</u>	
	to the right.
	to the left.
	right & left.
<u>Static</u>	

LEGENDE

<u>Porte tissu qui se deplace</u>	
	vers la droite.
	vers la gauche.
	vers droite et gauche.
<u>Porte tissu qui entraîne les autres porte-tissus</u>	
	vers la droite.
	vers la gauche.
	vers droite et gauche.
<u>Porte tissu fixe</u>	

 **El Panel Japonés Motorizado** está equipado con el **motor AS-04** de última generación apto tanto para uso doméstico, como comercial o industrial, debido a sus altas prestaciones.

El motor está diseñado para usar perfiles de 3, 4 ó 5 vías.

El largo máximo en el que fabricamos el panel es de 5,70 metros sin emplear ningún tipo de empalme.

Por el interior del perfil circula una correa dentada muy resistente por lo que la transmisión del desplazamiento es perfecta y muy silenciosa. Además, recubrimos el interior del perfil con un barniz que disminuye todavía más el rozamiento y por tanto, el ruido. Por otra parte, las correderas empleadas disponen de unas ruedas que facilitan el fluir de la cortina.

Cuenta con un detector automático de los límites finales de la carrera donde debe iniciarse la apertura y el cierre del panel. Esta función se puede programar también manualmente.

Opcionalmente se puede solicitar o bien un mando a distancia de 7 canales o un pulsador de pared de 2 canales. El mando a distancia tiene un alcance de 30 metros. La programación del sistema es muy fácil y rápida. Ambos sistemas pueden incluirse dentro del paquete de tecnología domótica que se esté empleando en el lugar de la instalación (consulte el manual de instrucciones).

El panel se sirve cortado a medida y preparado para el modo de apertura deseado: apertura izquierda o apertura derecha. El motor estará colocado a la derecha del perfil.

Otras características técnicas:

- Voltaje: 24VDC
- Velocidad: 95RPM
- Par torsor: 1 Nm
- Índice de Protección: IP41
- Peso: 0,56 Kg
- Receptor integrado en el motor.
- Final de carrera electrónico.
- Dispositivo térmico de protección contra sobrecargas eléctricas.
- Parada automática del sistema al finalizar su recorrido.
- Motor asincrónico, libre de interferencias.

Altran ofrece una Garantía de 2 años para todos sus Motores, a partir de la fecha de factura, salvo mal uso o rotura por parte del cliente-usuario-instalador.

Disponemos de información técnica adicional sobre este producto. Solicítela en caso de estar interesado.

We have at your disposal additional technical information about this product. Please, ask for it in case of interest.

Nous mettons à votre disposition des informations techniques supplémentaires sur ce produit. S'il vous plaît demander en cas d'intérêt.

 The **Motorized Sliding Panel** is equipped with the last generation **motor AS-04**, suitable for domestic, commercial or industrial purposes, due to its great performance.

The motor is designed to be used in tracks of 3, 4 and 5 channels. The maximum length in one piece is 5.70mts.

A high-resistance timing belt runs inside the guide profile thus ensuring a perfect and silent sliding. Moreover, the guide profile is coated with a special finish that decreases friction and noise. On the other hand, the runners used are wheeled, fact that facilitates the sliding of the curtain.

It includes an automatic detector of the opening and closing limit switches. This function can be programmed also manually.

Optionally a 7channels remote control or a 2channels wall switch can be ordered separately. The operating range of the remote control unit is 30 metres. The programming is very easy and quick. Both systems can be included in a domestic or home automation system installation (Pls refer to the instruction manual).

The track is supplied cut to measure and prepared for the desired opening mode: towards left or towards right. The motor will be placed in the right side.

Altran offers a 2 year warranty for all motors, from the date of invoice, unless misuse or failure by the customer-user-installer.

 Le **Panneau Japonais** est équipé d'un **moteur de dernière génération AS-04**, apte tant pour un usage domestique comme commercial et industriel grâce à ses grandes prestations.

Le moteur est dessiné pour son usage dans rails de 3, 4 et 5 voies. La longueur maximale dans une seule pièce est 5.70mts.

Dans l'intérieur du profil une courroie dentée très résistante circule silencieusement et avec un glissement parfait au système. De plus, la guide intérieure est recouverte d'un vernis spécial qui diminue le frottement et comme conséquence le bruit. Par ailleurs, les guidages coulissants facilitent le glissement du rideau.

Le système dispose d'un détecteur automatique des commutateurs de fin de course où on doit initier l'ouverture et la fermeture du panneau. Cette fonction peut être programmée aussi manuellement.

On peut optionnellement solliciter ou bien une télécommande de 7 canaux ou interrupteur mural manuel de 2 canaux. La portée de la télécommande est de 30 metres au maximum. La programmation du système est très facile et rapide. Les deux systèmes peuvent s'incorporer aux installations domotiques (SVP consultez le manuel d'instructions).

Le panneau se sert coupé sur mesure et préparé à la manière désirée d'ouverture: ramassage à gauche ou à droite. Le moteur sera placé dans le côté droit.

Altran offre une garantie de 2 ans pour tous les moteurs, à partir de la date de la facture, sauf utilisation incorrecte ou rupture de la part du client-utilisateur-installateur.

Additional technical specifications:

- Voltage: 24VDC.
- Speed: 95 RPM.
- Torque : 1 Nm.
- Protection rating : IP41.
- Weight: 0,56 Kg.
- Built-in receiver.
- 2 intermediate programmable positions.
- Automatic limit switch.
- Thermal overload protection.
- Built-in automatic start/stop.
- Asynchronous motor, interference-free.
- Store and recall job programming if power failure.

Autres caractéristiques techniques:

- Voltage: 24VDC .
- Vitesse: 95 RPM.
- Force de tension: 1 Nm.
- Classe de protection: IP41.
- Poids : 0,56 Kg.
- Récepteur intégré au moteur.
- 2 positions intermédiaires programmables.
- Fin de course électronique.
- Dispositif thermique de protection contre surcharges électriques.
- Arrêt automatique du système à la fin de course.
- Moteur asynchrone, sans interférence.
- Mémoire de programmation en cas d'absence d'électricité.

Panel Japonés Motorizado 3-4-5 VÍAS
 Motorized Sliding Panel 3-4-5 CHANNELS
 Parois Japonaise Motorisé 3-4-5 VOIES

Blanco
 White
 Blanc



*** Los precios incluyen transformador y soporte del transformador.**
 AC adapter and cradle included in the price.
 Adaptateur AC et support inclus dans le prix

**PANEL JAPONÉS
 MOTORIZADO
 3-4-5 VÍAS**

Conjuntos completos /
 Complete sets /
 Kits complets

* **No cobramos** incremento para portatela extra o doble mando. /
 * **We do not charge** any supplement for double cord or extra fabric-holders. /
 * Des porte-tissus extra ou double cordes sont fournis sans frais supplémentaires

Conjuntos Completos 3 Vías Complete Sets 3 channels Kits Complets 3 voies			Conjuntos Completos 4 Vías Complete Sets 4 channels / Kits Complets 4 voies			Conjuntos Completos 5 Vías Complete Sets 5 channels / Kits Complets 5 voies			Soportes Brackets Supports	
REF	U	€	REF	U	€	REF	U	€	cm	cm
E.81503M	1	590,38 €	E.81504M	1	604,72 €	E.81505M	1	617,66 €	3	150
E.82003M	1	617,76 €	E.82004M	1	634,54 €	E.82005M	1	650,22 €	4	200
E.82503M	1	643,04 €	E.82504M	1	662,50 €	E.82505M	1	680,72 €	4	250
E.83003M	1	670,10 €	E.83004M	1	692,94 €	E.83005M	1	713,56 €	4	300
E.83503M	1	697,48 €	E.83504M	1	723,00 €	E.83505M	1	746,12 €	5	350
E.84003M	1	722,74 €	E.84004M	1	751,00 €	E.84005M	1	776,56 €	5	400
E.84503M	1	748,04 €	E.84504M	1	779,02 €	E.84505M	1	807,06 €	5	450
E.85003M	1	775,42 €	E.85004M	1	809,12 €	E.85005M	1	839,64 €	6	500
E.85703M	1	810,78 €	E.85704M	1	848,32 €	E.85705M	1	882,28 €	6	600

Componentes Panel / Panel Components / Composants Paroi



Componentes Panel:

PerfilLongitud
 Terminales.....2
 Portatelas Velcrados....(Long. / n.º portatelas) + 5cm

Componentes Comunes:

Motor.....1
 Soporte Motor.....1
 Transformador.....1
 Soporte Transformador1
 Pletina Aluminio 40x3 mm.....Portatelas - 3cm
 Corredoras Portatelas.....4 x portatela
 Topes en L.....1 x portatela
 Topes en T.....1 x portatela
 Soportes.....Ver tabla
 Correa.....Long.perfil +48 dientes
 Blocacuerda.....1
 Tope con Tornillo.....1
 Cinta Velour Hembra 20 mm.....Según Nº Portatelas
 Protector Pletina.....2 x Pletina
 Tapas Portatela.....2 (1 izq. + 1 dcha.)
 x Nº Portatelas



Panel Components:

Track.....Length
 Endcaps.....2
 Fabric Holder.....(Length/n.º fabric holders) + 5cm

Standard Components:

Motor.....1
 Holder for Motor.....1
 AC Adapter.....1
 Holder for AC Adapter.....1
 40 x 3 mm. Aluminium Batten...Fabric Holders - 3cm
 Fabric-Holder runners.....4 x Fabric Holder
 L - shaped endstop.....1 x Fabric Holder
 T - shaped endstop.....1 x Fabric Holder
 Brackets.....See table
 Belt-DriveLength of the profile + 48 teeth
 Belt-Lock1
 Endstop w/screw.....1
 Velour 20 mm loop tape.....Depending on #F.Holders
 Protector Batten.....2 x Batten
 Fabric-holder end caps2 (1 left + 1 right)
 x number of F.Holders



Composants Parois:

Rail.....Largeur
 Bouchons.....2
 Rail Velcro.....(Longeur / no. fabric holders) + 5cm

Composants Communs:

Moteur.....1
 Support Moteur.....1
 Transformateur.....1
 Support Transformateur.....1
 Bâton Aluminium 40 x 3 mm.....Rail Velcro - 3cm
 Galet porteur de tissus.....4 x Rail Velcro
 Arrêt en L.....1 x Rail Velcro
 Arrêt en T.....1 x Rail Velcro
 Supports.....Voir tableau
 Courroie Dentée.....Longeur du rail + 48 Dents
 Frein-Courroie.....1
 Vis finale.....1
 Velour femelle.....Selon porte-tissus
 Protecteur Barre de Lestage.....2 x Barre
 Bouchons pour porte-tissus.....2 (1gauche + 1droite)
 x nombre de porte tissus

Riel Aluminio Panel Japonés Motorizado 3 Vías
Aluminium track for motorized sliding panel 3 channels / Profil alu pour Parois japonaise motorisé 3 voies

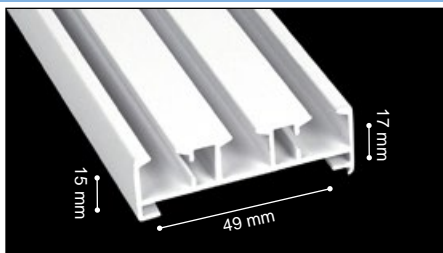

REF	Ø	U	€	€	cm
C.120143BLM		57 m	14,46 €/m	16,63 €/m	570

Riel Aluminio Panel Japonés Motorizado 4 Vías
Aluminium track for motorized sliding panel 4 channels / Profil alu pour Parois japonaise motorisé 4 voies

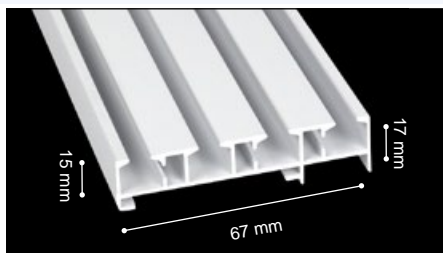

REF	Ø	U	€	€	cm
C.120144BLM		57 m	19,46 €/m	22,38 €/m	570

Riel Aluminio Panel Japonés Motorizado 5 Vías
Aluminium track for motorized sliding panel 5 channels / Profil alu pour Parois japonaise motorisé 5 voies

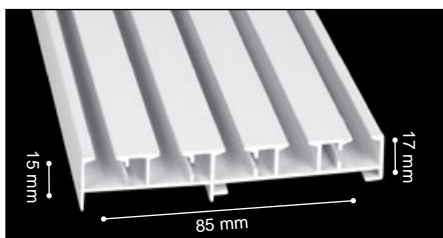

REF	Ø	U	€	€	cm
C.120145BLM		57 m	23,92 €/m	27,51 €/m	570

Perfil Portatelas de Aluminio Velcro
Fabric Holder / Rail Aluminium Velcro



REF	Ø	U	€	€	cm
C.12021BL		57 m	10,88 €/m	12,51 €/m	570

Pletina Aluminio 408 mm.
408 mm. Aluminium Batten / Bâton Aluminium 408 mm.



REF	Ø	U	€	€	cm
C.12001BL (319g.)		10	6,14 €/m	7,06 €/m	600

Pletina Contrapeso Metacrilato Transp. (40x5mm)
Transparent acrylic Batten (40x5mm) / Barre de metacrylate transparente (40x5mm)



REF	Ø	U	€	€	cm
C.12023TR4000 (236g)		40	9,60 €/m	11,04 €/m	400

Mando a Distancia
Remote Control / Télécommande



REF	Ø	U	€	€	cm
J.R113		1		53,28 €	

Pulsador Doble
Double Motor Wall Switch / Interrupteur Double

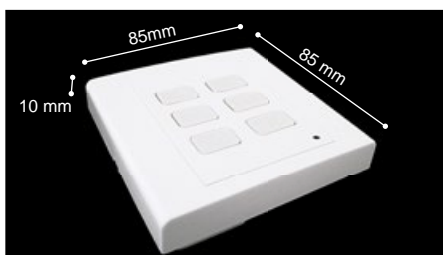

REF	Ø	U	€	€	cm
J.R112		1		31,92 €	

* Se sire con caja de plástico para instalar el soporte empotrado en la pared. / Supplied with plastic box to insert the bracket into the wall. / Fourni avec boîte en plastic pour insérer le support au mur.



Motor
Panel Japonés
Sliding panel motor /
Moteur panneau
japonais

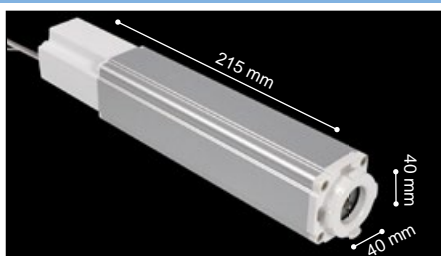

REF	Ø	U	€	1	cm
D.1024		1		349,46 €	

Tapa
Panel Japonés
Motoria do
3 v as
3 Channel endcap /
Bouchon
finale 3 voies



REF	Ø	U	€	1	cm
D.1025		10	1,70 €	1,96 €	

Tapa MOTOR
Panel Japonés
Motoria do
3 v as
3 Channel endcap /
Bouchon finale
3 v ies



REF	Ø	U	€	1	cm
D.1028		10	42,88 €	49,31 €	

Tapa
Panel Japonés
Motoria do
4 v as
4 Channel endcap /
Bouchon finale
4 v ies



REF	Ø	U	€	1	cm
D.1026		10	2,86 €	3,29 €	

Tapa MOTOR
Panel Japonés
Motoria do
4 v as
4 Channel endcap/
Bouchon finale
4 v ies



REF	Ø	U	€	1	cm
D.1029		10	43,20 €	49,68 €	

Tapa Panel
Japonés
Motoria do 5 v as
5 Channel
endcap /
Bouchon finale
5 v ies



REF	Ø	U	€	1	cm
D.1027		10	3,32 €	3,82 €	

Tapa MOTOR
Panel Japonés
Motoria do
5 v as
5 Channel endcap /
Bouchon finale
5 v ies



REF	Ø	U	€	1	cm
D.1030		10	44,24 €	50,88 €	

Soporte
Panel Japonés
Motoria do
Motoria d sliding
panel bracket /
Support
Parois Japonaise
Motorisée

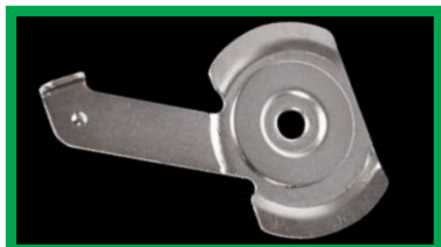

REF	Ø	U	€	1	cm
D.1031		10	1,90 €	2,19 €	

* Soporte incluido en el kit /
Bracket supplied in the kit / Support fourni dans le kit.



Blocacuerda
de la Correa
Panel Japonés
Motorizad



Lock for motorizad
Sliding Panel belt /
Frein pour courroie
Parois Japonaise
Motorisé

REF	∅	U	€	€	cm
D.1032		10	0,56 €	0,67 €	

Soporte Motor
Panel Japonés
Motorizad

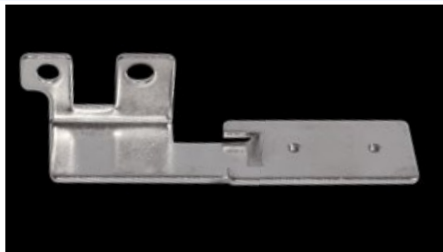

Holder for
sliding panel motor /
Support pour
moteur parois japonais

REF	∅	U	€	€	cm
D.1034		10	2,10 €	2,42 €	

Correa
Panel Japonés
Motorizad

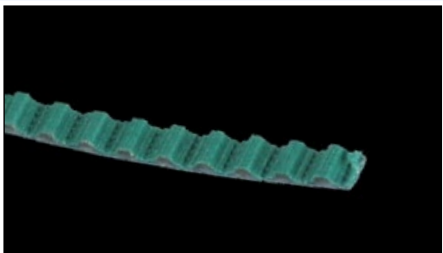

Drive belt for
motorizad sliding
panel /
Courroie parois
japonais motorisé

REF	∅	U	€	€	cm
D.1035		20	9,52 €	10,95 €	

Correderas
Portatelas



Fabric-Holder Runner /
Glisseur Porteur de
Tissus

REF	∅	U	€	€	cm
D.1033		10	0,56 €	0,67 €	

Tope T
Panel Japonés
Motorizad



T-shaped Enstop
Motorizad /
Arrêt en T Motorisé

REF	∅	U	€	€	cm
D.1036		20	0,56 €	0,67 €	

Tope L
Panel Japonés
Motorizad



L-shaped Enstop
Motorizad /
Arrêt en L Motorisé

REF	∅	U	€	€	cm
D.1037		50	0,56 €	0,67 €	

Cinta Velcro Hembra
Velour 20 mm

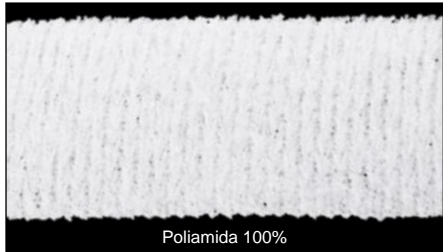

Touch&Close Fastener
Tape (Loop Section) /
Velcro femelle

Poliamida 100%

REF	COLOR	rollo (m) roll (m)	€	RAPPORT	mm
D.20A (Velour)	blanco/white	50 m	0,60 €/m	-	20 mm
D.5 (Astrakan)	blanco/white	50 m	0,41 €/m	-	20 mm
D.5AD (Astrakan Adhes.)	blanco/white	50 m	0,92 €/m	-	20 mm

Protector de Pletina
30



Protector Batten
30 /
Protecteur Barre de
lestage 30

REF	∅	U	€	€	cm
D.310		500	0,266 €	0,319 €	



Soporte Múltiple de Pared Blanco

White Wall Ek ension Bracket / Support Mural Blanc



REF	∅	U	€	€ ¹	cm
D.301BL		25	1,98 €	2,38 €	4
D.302BL		25	2,08 €	2,50 €	6
D.303BL		25	2,36 €	2,83 €	10
D.304BL		25	3,00 €	3,60 €	15
D.305BL		25	4,78 €	5,74 €	20

Soporte Múltiple de Pared Ek rafuerte

Wall Ek ension Bracket (Extrastrong) / Support Mural Ek rafort



REF	∅	U	€	€ ¹	cm
D.3001BL		25	3,46 €	3,98 €	7
D.3002BL		25	4,16 €	4,78 €	11
D.3003BL		25	4,94 €	5,68 €	15
D.3004BL		25	5,18 €	5,96 €	19
D.3005BL		25	5,38 €	6,19 €	23

Transformador

Adaptor / Transformateur



REF	∅	U	€	€ ¹	cm
D.1020		1		52,58 €	

Soporte para transformador

Adaptor Bracket / Support Transformateur



REF	∅	U	€	€ ¹	cm
D.1021		1		5,84 €	

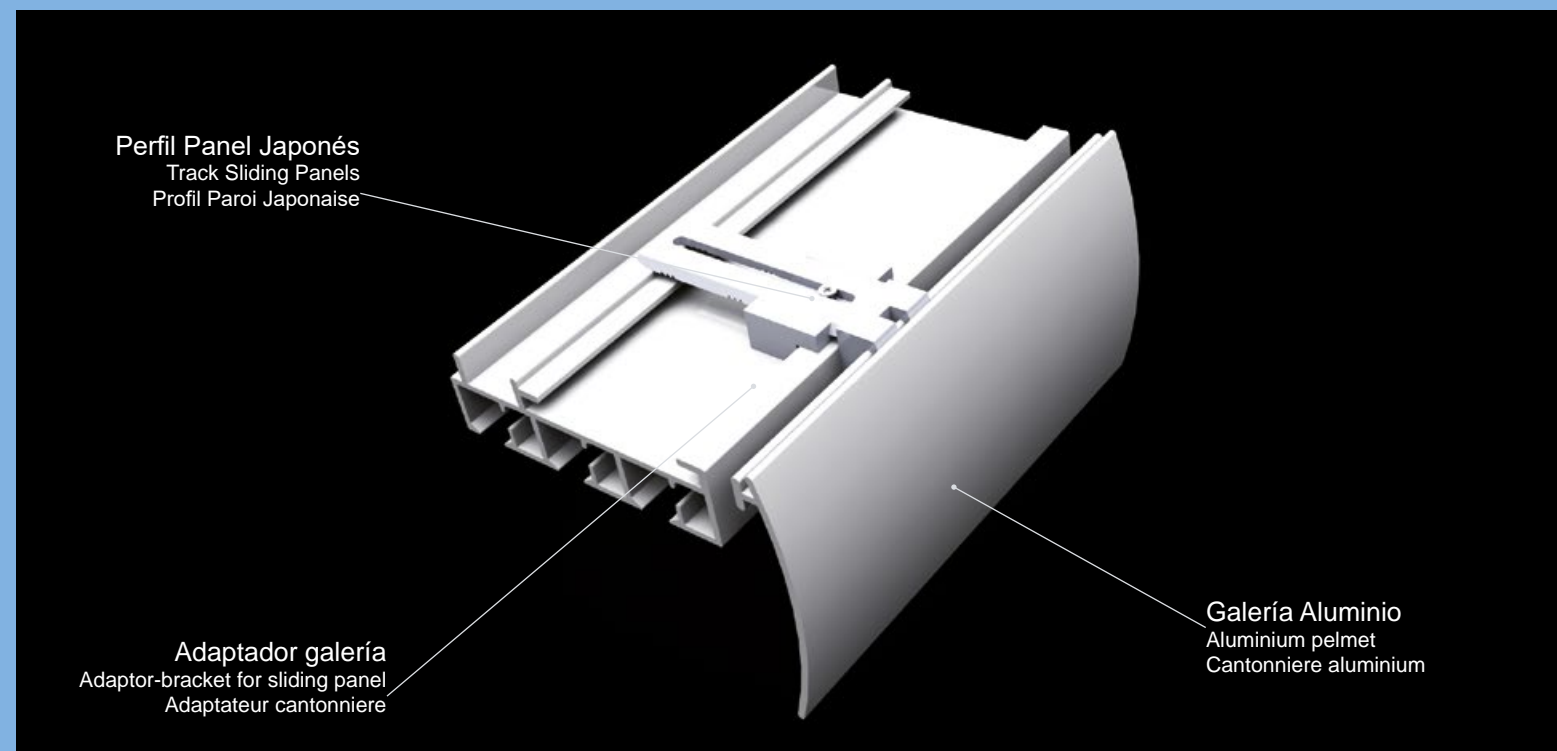

Galería Aluminio Anodizado

Anodized Aluminium Pelmet / Cantonniere Aluminium Anodisé

REF					
C.1203552AP	60	5,40 €/m	6,21€/m	52	600
C.1203580AP	60	8,14 €/m	9,36 €/m	80	600

Galería Aluminio Blanca

White Aluminium Pelmet / Cantonniere Aluminium Blanc

REF					
C.1203552BL	60	4,96 €/m	5,70 €/m	52	600
C.1203580BL	60	7,34 €/m	8,44 €/m	80	600

Adaptador Galeria Panel Japonés

Adaptor-bracket for Sliding Panel / Adaptateur Cantonniere Paroi Japonaise

REF					
D.90		50	1,16 €	1,33 €	

* El adaptador sirve para todos los perfiles desde 2 hasta 5 vías.
The adaptor-bracket can be used on all sliding-panel rails.
L'adaptateur peut être utilisé avec tous les profils de 2 a 5 voies.

Panel Japonés Codo

Elbow / Coude

REF					
D.2033BL		20	1,16 €	1,33 €	

* Sólo disponible para la galería de 8 cm.
Only available for 8 cm pelmet / Seulement disponible pour cantonniere 8 cm.

Panel Japonés Codo

Elbow / Coude

REF					
D.2033GR		20	1,16 €	1,33 €	

* Sólo disponible para la galería de 8 cm.
Only available for 8 cm pelmet / Seulement disponible pour cantonniere 8 cm.

CODIGO CLIENTE..... NOMBRE CLIENTE.....
 FECHA PEDIDO..... POBLACIÓN.....
 OBSERVACIONES.....

REFERENCIA	CANTIDAD	MEDIDA PANEL	Nº Vías	Nº TOTAL PORTATELAS	MEDIDA(2) PORTATELAS	POSICIÓN PORTATELA FIJO			POSICIÓN CUERDA			ALTURA CUERDA(2)	PORTATELAS EXTRA		CROQUIIS DEL PANEL	¿MOTOR?	
						DERECHA	IZQUIERDA	CENTRAL	DERECHA	IZQUIERDA	SISTEMA NORMAL 11.8000		SISTEMA ESTOR 11.8001				

(1) DEBE AÑADIRSE EN EL PEDIDO EL RESULTADO DE ESTAS CASILLAS CON SUS CÓDIGOS CORRESPONDIENTES.

(2) RELLENAR SÓLO SI EL CLIENTE LO ESPECIFICA

NOTA: EL STANDARD DE MONTAJE DE PANELES ES EL SIGUIENTE:

- SISTEMA DE CUERDA (1.5M)
- SISTEMA DE INSTALACIÓN TRASERO
- PORTATELAS FIJO EN POSICIÓN DELANTERA
- MEDIDA PORTATELAS=(MEDIDA PANEL/NºPORTATELAS)+5CM

SIMBOLOGÍA



CUSTOMER N° / CODE CLIENT..... CUSTOMER NAME / NOM CLIENT.....

ORDER DATE / DATE COMMANDE..... ADDRESS / VILLE.....

REMARKS / OBSERVATIONS.....

REFERENCE / RÉFÉRENCE	QUANTITY / QUANTITÉ	PANEL WIDTH / MESURE PANNEAU	N° CHANNELS / N° VOIES	TOTAL N° OF FABRIC-HOLDERS / N° TOTAL PORTE-TISSUS	FABRIC-HOLDERS WIDTH (2) / MESURE(2) PORTE TISSUS	FABRIC-HOLDER / POSITION PORTE-TISSUS FIXE			CORD POSITION(1) / POSITION CORDE (1)			CORD HEIGHT / HAUTEUR CORDE			EXTRA F-HOLDER / P-TISSUS EXTRA(1)		SKETCH OF PANEL / DESSIN DU PANNEAU	MOTOR / MOTEUR	
						RIGHT / DROITE	LEFT / GAUCHE	CENTER CENTRE	RIGHT / DROITE	LEFT / GAUCHE	CENTER CENTRE	RIGHT / DROITE	LEFT / GAUCHE	CENTER CENTRE	RIGHT / DROITE	LEFT / GAUCHE			CENTER CENTRE

(1) ORDER MUST INCLUDE REF. NUMBERS OF ALL FILLED-IN COLUMNS / EN CAS DE COMMANDE DE SYSTÈME STORE, LE RAJOUTER DANS LA COMMANDE.

(2) TO BE FILLED IN ONLY WHEN REQUIRED BY CUSTOMER / REMPLIR SEULEMENT SI LE CLIENT LE SPÉCIFIE.

NOTE / NOTE: STANDAR ASSEMBLY IS AS FOLLOWS: / LE STANDARD DU MONTAGE EST LE SUIVANT.

REVERSE SIDE INSTALLATION SYSTEM / SYSTÈME D'INSTALLATION ARRIÈRE

STATIC FABRIC-HOLDER IN FRONT POSITION / PORTE-TISSUS FIXE EN POSITION PREMIERE.

FABRIC-HOLDER WIDTH= (PANEL WIDTH / N° OF FABRIC-HOLDERS + 5CMS / MESURE PORTE-TISSUS= (MESURE PANNEAU / N° PORTE-TISSUS) + 5CMS.



Accesorios de Confección · Varios

tailoring accessories · miscellaneous

accessoires de confection · divers



ALTRAN[®]
SISTEMAS PARA DECORAR CORTINAS



ALTRAN[®]
SISTEMAS PARA DECORAR CORTINAS

ACCESORIOS PARA CONFECCIONAR CORTINAS
cintas · ollaos · ganchos · tiradores · contrapesos · prensas



 **ALTRAN**

Garfios / Hooks / Crochets

Caja de 1000 ganchos de plástico EXTRA FUERTES EXTRASTRONG Hook Box for tape 1000 u / Boîte de 1000 crochets pour ruban EXTRAFORTS



REF	∅	U	€	1	cm
D.399		1000	37,70 €		

Caja de 1000 ganchos Hook Box for tape 1000 u / Boîte de 1000 crochets pour ruban

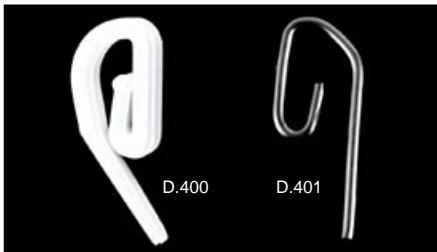

REF	∅	U	€	1	cm
D.400		1000	15,70 €		
D.401		1000	16,38 €		

Caja de 100 ganchos regulable de plástico

Adjustable plastic Hooks for tape Box 100 u / Boîte de crochets réglables pour ruban



REF	∅	U	€	1	cm
D.394		100	22,24 €		

Gancho Pincho Caja 500 u

Metal Hook Box 500 u / Boîte de crochets en Métal 500 u

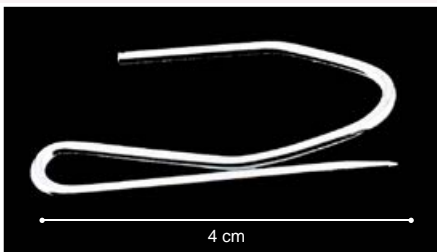

REF	∅	U	€	1	cm
D.395		500	15,92 €		

Gancho Ancla Caja

Anchor hook Box / Boîte de crochets en Ancre



REF	∅	U	€	1	cm
D.396		1000	27,52 €		
D.398		500	52,44 €		

Gancho Espada Caja 1000 u

Sword Hook Box with 1000 u / Boîte de crochets Épée 500 u

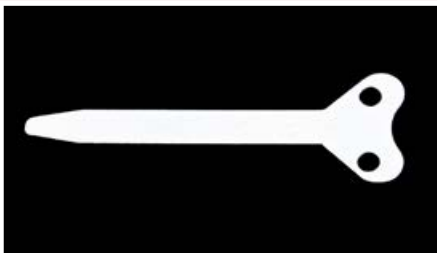

REF	∅	U	€	1	cm
D.397		1000	38,24 €		

Caja 100 Balancines

Box of 100 toggle bolts / Boîte de 100 balancelle

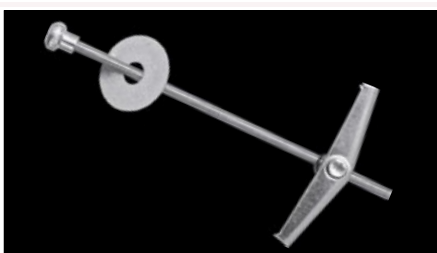

REF	∅	U	€	1	cm
G.20		100	214,00 €		

Cintas Onda Perfecta / Perfect Wave Tapes / Rubans Onde Parfaite

Cinta Armadora
Onda Perfecta
75 mm. 2 Bolsas

Perfect wave buck am
75mm 2 pockets /
Buck am onde parfaite
75mm 2 pouches

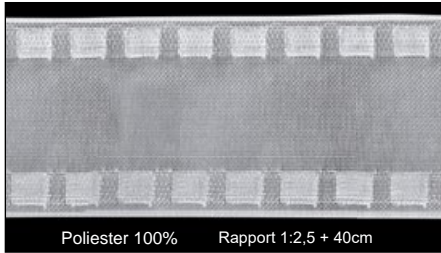

Poliester 100% Rapport 1:2,5 + 40cm

REF	COLOR	rollo (m) roll (m)	€	RAPPORT	
D.230TR	transparente	100 m	1,20 €/m	1:2,5 (+40 cm)	75 mm
D.231TR	transparente	150 m	0,84 €/m	1:2,5 (+40 cm)	75 mm

Cinta Armadora
Onda Confort
75 mm. 2 Bolsas

Confort wave buck am
75mm 2 pockets /
Buck am Onde
Confort 75mm 2
pouches

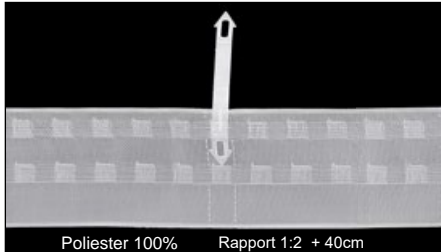

Poliester 100% Rapport 1:2 + 40cm

REF	COLOR	rollo (m) roll (m)	€	RAPPORT	
D.287TR	transparente	100 m	1,02 €/m	1:2 (+40 cm)	75 mm

* Los Onduladores no están incluidos.
Wawings are not included / Ondulatoires ne pas inclus.

Ondulador
Plástico Flecha
Caja 100 unidades

Arrow plastic waving
Box 100 u/
Ruban fleche
ondulatoire en plastic
100 u

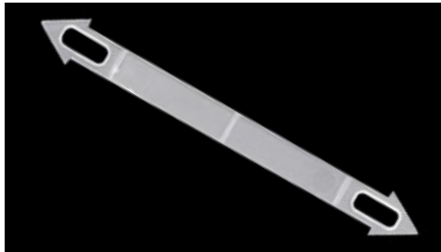

REF	COLOR	rollo (m) roll (m)	€	RAPPORT	
H.120	transparente	1	23,74 €	-	

Información General / General Information / Informations Générales

Cinta adaptable para obtener el resultado Onda Confort tanto en Rieles como en Barras.

Adaptable tape to get the Confort wave result in tracks and poles / Ruban adaptatif pour réussir l'Onde Confort dans rails et tringles.

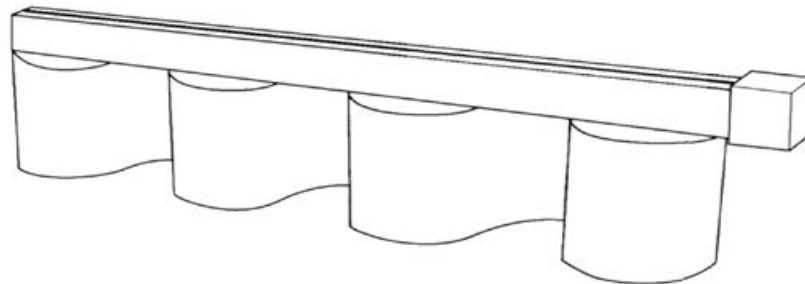

Onda Perfecta vs Onda Confort.

En la Onda Perfecta, la Onda siempre será igual porque la ondulación se hace gracias a las correderas, mientras que la Onda Confort depende del espacio entre onduladores. En la Onda Perfecta la Onda Frontal y Trasera son Idénticas. En la Onda Confort la Onda Trasera quedará Plana si la cortina está extendida. Usted decide el rapport, la cantidad de tela que quiere gastar y el tipo de onda usando los onduladores.

With the perfect wave tape, the waves have all the same size since the waving is a result of the runners space, whereas the size of Confort wave depends on the space marked by the arrows. In the perfect wave system, the front and the back waves are identical. In the confort wave system, the back wave will remain flat when the curtain is fully extended. You decide the rapport, the quantity of fabric that you need and the type of wave you want to get by using the wavings.

Dans le cas du ruban onde parfaite, les ondes ont toutes le même mesure prévue en raison des glisseurs, tandis que le ruban onde confort dépend de l'espace marqué par les fleches. Dans le système onde parfaite, les ondes sûr devant et derrière sont identiques. Dans le système d'onde Confort, l'onde sûr devant restera plate avec le rideau déplié. Vous decidez le rapport, la quantité de tissu et le type d'onde que vous voulez créer avec l'utilisation des ondulateurs.

Gancho
Hook
Crochet



Onduladores
Waving
Ondulatoire

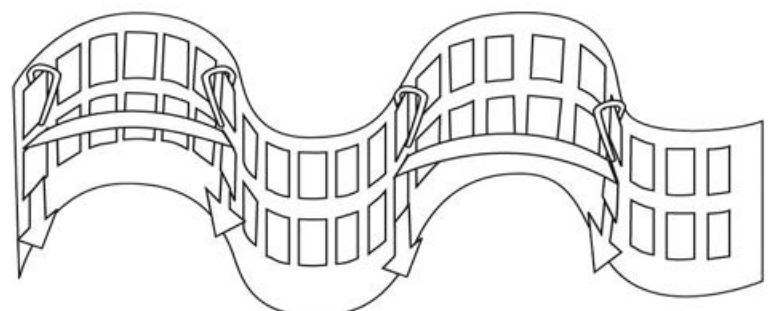
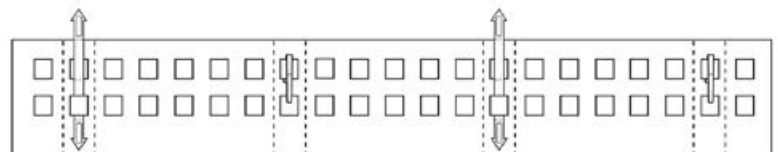
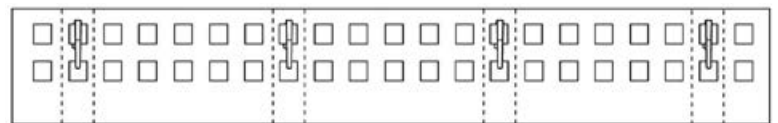
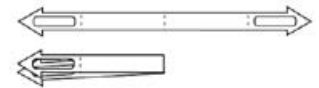



Cintas para estores / Roman Tapes for Lathes / Rubans Romains pour Joncs

Cinta paquete con Anillas Paso 15

Roman Blind Tape w/rings space 15 / Store Romain avec Anneaux pas 15

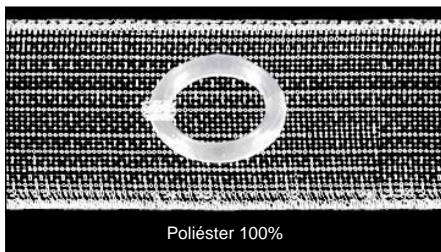

Poliéster 100%

REF	COLOR	rollo (m) roll (m)	€	RAPPORT	
D.219TR	transparente	150 m	0,98 €/m	-	16 mm

Estor Varillas Tubular

1 Stitching / Une couture

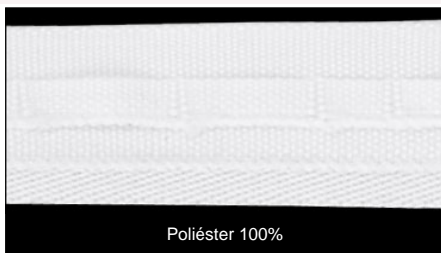

Poliéster 100%

REF	COLOR	rollo (m) roll (m)	€	RAPPORT	
D.14T	blanco/white	300 m	0,58 €/m	-	16 mm
D.14TBG	beige	300 m	0,58 €/m	-	16 mm
D.14TTR	transparente	300 m	0,60 €/m	-	16 mm

Estor Varillas

Double Stitching / Double couture

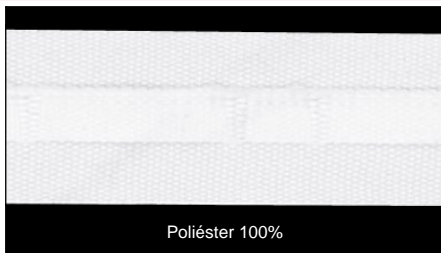

Poliéster 100%

REF	COLOR	rollo (m) roll (m)	€	RAPPORT	
D.14	blanco/white	300 m	0,31 €/m	-	16 mm
D.14BG	beige	300 m	0,31 €/m	-	16 mm

Estor Varillas

Double Stitching / Double couture

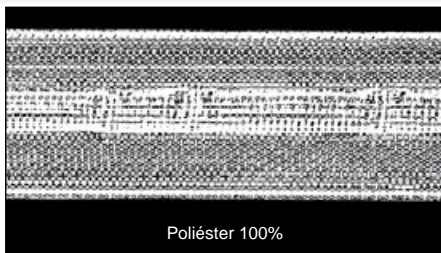

Poliéster 100%

REF	COLOR	rollo (m) roll (m)	€	RAPPORT	
D.14TR	transparente	300 m	0,41 €/m	-	16 mm

Estor Paquete



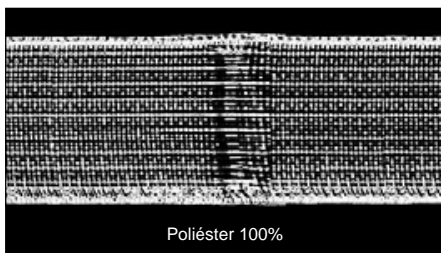



Tape for Austrian Blinds / Ruban pour Store Autrichien

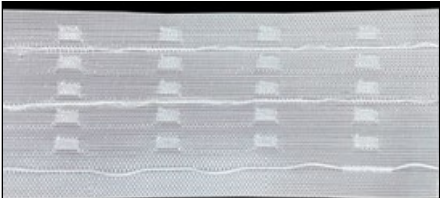

Poliéster 100%

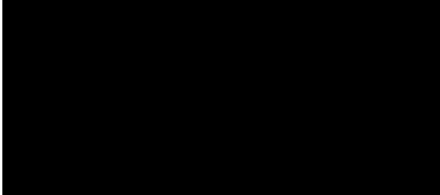
REF	COLOR	rollo (m) roll (m)	€	RAPPORT	
D.10TR	transparente	300 m	0,41 €/m	-	16 mm

Cintas automáticas / Curtain tapes / Rubans fronceurs automatiques

<p>Cinta fruncidora Shirring tape / Ruban fronceurs</p>	 Poliéster 100% Rapport 1:2 - 5 Bolsas (Bags) - 3 Cordones (Cords)	<table border="1"> <thead> <tr> <th>REF</th> <th>COLOR</th> <th>rollo (m) roll (m)</th> <th></th> <th>RAPPORT</th> <th></th> </tr> </thead> <tbody> <tr> <td>D.224TR</td> <td>transparente</td> <td>150 m</td> <td>1,02 €/m</td> <td>1:2</td> <td>75 mm</td> </tr> </tbody> </table>	REF	COLOR	rollo (m) roll (m)		RAPPORT		D.224TR	transparente	150 m	1,02 €/m	1:2	75 mm						
REF	COLOR	rollo (m) roll (m)		RAPPORT																
D.224TR	transparente	150 m	1,02 €/m	1:2	75 mm															
<p>Automática 45 Automatic tape 45 / Ruban automatique 45</p>	 Poliéster 100% Rapport 1:2 - 2 Bolsas (Bags) - 2 Cordones (Cords)	<table border="1"> <thead> <tr> <th>REF</th> <th>COLOR</th> <th>rollo (m) roll (m)</th> <th></th> <th>RAPPORT</th> <th></th> </tr> </thead> <tbody> <tr> <td>D.58</td> <td>blanco/white</td> <td>150 m</td> <td>0,64 €/m</td> <td>1:2</td> <td>45 mm</td> </tr> </tbody> </table>	REF	COLOR	rollo (m) roll (m)		RAPPORT		D.58	blanco/white	150 m	0,64 €/m	1:2	45 mm						
REF	COLOR	rollo (m) roll (m)		RAPPORT																
D.58	blanco/white	150 m	0,64 €/m	1:2	45 mm															
<p>Automática 65 Automatic tape 65 / Ruban automatique 65</p>	 Poliéster 100% Rapport 1:2 - 2 Bolsas (Bags) - 2 Cordones (Cords)	<table border="1"> <thead> <tr> <th>REF</th> <th>COLOR</th> <th>rollo (m) roll (m)</th> <th></th> <th>RAPPORT</th> <th></th> </tr> </thead> <tbody> <tr> <td>D.57</td> <td>blanco/white</td> <td>150 m</td> <td>0,84 €/m</td> <td>1:2</td> <td>65 mm</td> </tr> <tr> <td>D.57BG</td> <td>beige</td> <td>150 m</td> <td>0,84 €/m</td> <td>1:2</td> <td>65 mm</td> </tr> </tbody> </table>	REF	COLOR	rollo (m) roll (m)		RAPPORT		D.57	blanco/white	150 m	0,84 €/m	1:2	65 mm	D.57BG	beige	150 m	0,84 €/m	1:2	65 mm
REF	COLOR	rollo (m) roll (m)		RAPPORT																
D.57	blanco/white	150 m	0,84 €/m	1:2	65 mm															
D.57BG	beige	150 m	0,84 €/m	1:2	65 mm															
<p>Automática 65 Automatic tape 65 / Ruban automatique 65</p>	 Polipropileno 100% Rapport 1:2 - 2 Bolsas (Bags) - 2 Cordones (Cords)	<table border="1"> <thead> <tr> <th>REF</th> <th>COLOR</th> <th>rollo (m) roll (m)</th> <th></th> <th>RAPPORT</th> <th></th> </tr> </thead> <tbody> <tr> <td>D.59</td> <td>blanco/white</td> <td>150 m</td> <td>0,64 €/m</td> <td>1:2</td> <td>65 mm</td> </tr> <tr> <td>D.159</td> <td>beige</td> <td>150 m</td> <td>0,64 €/m</td> <td>1:2</td> <td>65 mm</td> </tr> </tbody> </table>	REF	COLOR	rollo (m) roll (m)		RAPPORT		D.59	blanco/white	150 m	0,64 €/m	1:2	65 mm	D.159	beige	150 m	0,64 €/m	1:2	65 mm
REF	COLOR	rollo (m) roll (m)		RAPPORT																
D.59	blanco/white	150 m	0,64 €/m	1:2	65 mm															
D.159	beige	150 m	0,64 €/m	1:2	65 mm															
<p>Automática 5 bolsas 5-Pock t / 5 Poches</p>	 Polipropileno 100% Rapport 1:2 - 5 Bolsas (Bags) - 2 Cordones (Cords)	<table border="1"> <thead> <tr> <th>REF</th> <th>COLOR</th> <th>rollo (m) roll (m)</th> <th></th> <th>RAPPORT</th> <th></th> </tr> </thead> <tbody> <tr> <td>D.226</td> <td>blanco/white</td> <td>150 m</td> <td>0,68 €/m</td> <td>1:2</td> <td>70 mm</td> </tr> <tr> <td>D.226BG</td> <td>beige</td> <td>150 m</td> <td>0,68 €/m</td> <td>1:2</td> <td>70 mm</td> </tr> </tbody> </table>	REF	COLOR	rollo (m) roll (m)		RAPPORT		D.226	blanco/white	150 m	0,68 €/m	1:2	70 mm	D.226BG	beige	150 m	0,68 €/m	1:2	70 mm
REF	COLOR	rollo (m) roll (m)		RAPPORT																
D.226	blanco/white	150 m	0,68 €/m	1:2	70 mm															
D.226BG	beige	150 m	0,68 €/m	1:2	70 mm															
<p>Automática 5 bolsas 5-Pock t / 5 Poches</p>	 Poliéster 100% Rapport 1:2 - 5 Bolsas (Bags) - 3 Cordones (Cords)	<table border="1"> <thead> <tr> <th>REF</th> <th>COLOR</th> <th>rollo (m) roll (m)</th> <th></th> <th>RAPPORT</th> <th></th> </tr> </thead> <tbody> <tr> <td>D.62</td> <td>blanco/white</td> <td>150 m</td> <td>0,92 €/m</td> <td>1:2</td> <td>75 mm</td> </tr> <tr> <td>D.62BG</td> <td>beige</td> <td>150 m</td> <td>0,92 €/m</td> <td>1:2</td> <td>75 mm</td> </tr> </tbody> </table>	REF	COLOR	rollo (m) roll (m)		RAPPORT		D.62	blanco/white	150 m	0,92 €/m	1:2	75 mm	D.62BG	beige	150 m	0,92 €/m	1:2	75 mm
REF	COLOR	rollo (m) roll (m)		RAPPORT																
D.62	blanco/white	150 m	0,92 €/m	1:2	75 mm															
D.62BG	beige	150 m	0,92 €/m	1:2	75 mm															
<p>Automática 5 bolsas 5-Pock t / 5 Poches</p>	 Poliéster 100% Rapport 1:2 - 5 Bolsas (Bags) - 4 Cordones (Cords)	<table border="1"> <thead> <tr> <th>REF</th> <th>COLOR</th> <th>rollo (m) roll (m)</th> <th></th> <th>RAPPORT</th> <th></th> </tr> </thead> <tbody> <tr> <td>D.228</td> <td>blanco/white</td> <td>100 m</td> <td>1,46 €/m</td> <td>1:2</td> <td>120 mm</td> </tr> </tbody> </table>	REF	COLOR	rollo (m) roll (m)		RAPPORT		D.228	blanco/white	100 m	1,46 €/m	1:2	120 mm						
REF	COLOR	rollo (m) roll (m)		RAPPORT																
D.228	blanco/white	100 m	1,46 €/m	1:2	120 mm															

Cintas fantasía/ Curtain Tape / Rubans Fronceurs fantasie

Cinta fruncidora especial

Special shirring Tape transparent / Ruban fronceurs spécial



Poliéster 100%
Rapport 1:2 - 5 Bolsas (Bags) - 4 Cordones (Cords)

REF	COLOR	rollo (m) roll (m)	€	RAPPORT	
D.236TR	transparente	100 m	1,38 €/m	1:2	120 mm

Tablas 5 bolsas

5-Pocket pleat / Pli 5 Poches

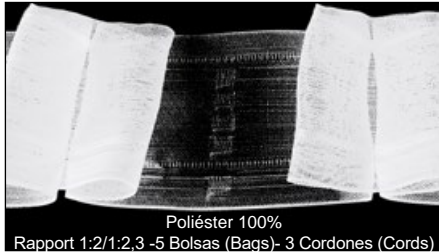

Poliéster 100%
Rapport 1:2/1:2:3 - 5 Bolsas (Bags) - 3 Cordones (Cords)

REF	COLOR	rollo (m) roll (m)	€	RAPPORT	
D.213	blanco/white	150 m	0,96 €/m	1:2	75 mm
D.213BG	beige	150 m	0,96 €/m	1:2	75 mm
D.214	blanco/white	150 m	0,94 €/m	1:2,3	75 mm
D.214BG	beige	150 m	0,94 €/m	1:2,3	75 mm

Triple pliegue

Triple pleat / 3 Pli



Poliéster 100%
Rapport 1:2 - 5 Bolsas (Bags) - 3 Cordones (Cords)

REF	COLOR	rollo (m) roll (m)	€	RAPPORT	
D.215	blanco/white	150 m	0,88 €/m	1:2	75 mm
D.215BG	beige	150 m	0,88 €/m	1:2	75 mm

Nido de abeja

Diamond / Nid d'abeille

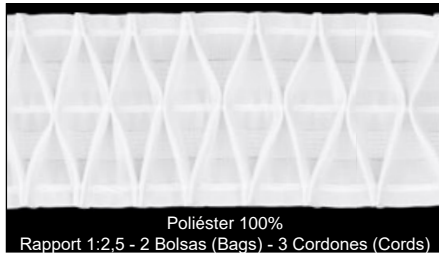

Poliéster 100%
Rapport 1:2,5 - 2 Bolsas (Bags) - 3 Cordones (Cords)

REF	COLOR	rollo (m) roll (m)	€	RAPPORT	
D.65	blanco/white	150 m	0,88 €/m	1:2,5	85 mm

Cintas cierre / Fastener tapes / Rubans à l'cro

Cinta cierre macho 20mm.

20 mm. Touch&close fastener Tape (Hook section) / Velcro male 20mm.

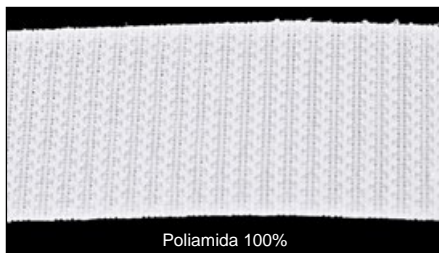

Poliamida 100%

REF	COLOR	rollo (m) roll (m)	€	RAPPORT	
D.21 (Setax)	blanco/white	50 m	0,58 €/m	-	20 mm

Cinta cierre macho adhesiva 20mm.

Touch&close Adhesive fast. Tape (Hook section) / Velcro adhesif male 20mm.

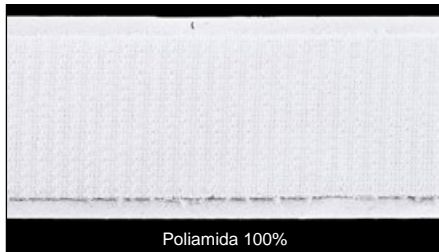

Poliamida 100%

REF	COLOR	rollo (m) roll (m)	€	RAPPORT	
D.18 (Setax)	blanco/white	50 m	1,06 €/m	-	20 mm

Cinta Cierre-Velcro Hembra 20mm.



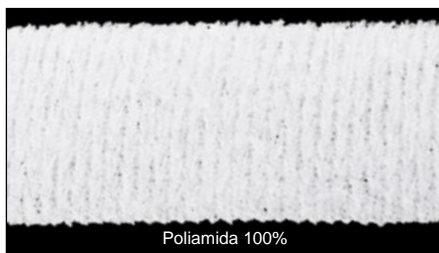

20 mm Touch&close fastener Tape (Loop section) / Velcro femelle 20mm.

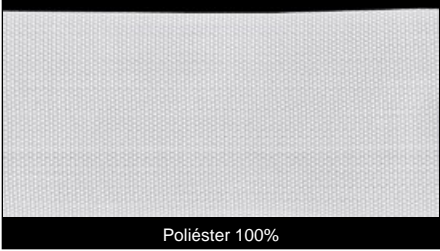
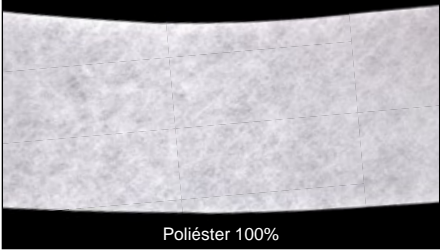

Poliamida 100%

REF	COLOR	rollo (m) roll (m)	€	RAPPORT	
D.20A (Velour)	blanco/white	50 m	0,60 €/m	-	20 mm
D.5 (Astrakan)	blanco/white	50 m	0,41 €/m	-	20 mm
D.5AD (Astrakan Adhes.)	blanco/white	50 m	0,92 €/m	-	20 mm

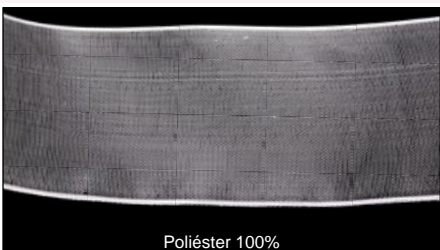
Cintas armadoras / Buck am / Buck am

Armadora Buck am / Ruban entoilage sans pouches	 Poliéster 100%	REF	COLOR	rollo (m) roll (m)		RAPPORT	
		D.63	blanco/white	200 m	0,58 €/m	-	70 mm
		D.67	blanco/white	200 m	0,60 €/m	-	80 mm
		D.64	blanco/white	200 m	0,62 €/m	-	90 mm
		D.64BG	beige	200 m	0,62 €/m	-	90 mm
Entretela armadora Interlining Buck am / Ruban entoilage	 Poliéster 100%	REF	COLOR	rollo (m) roll (m)		RAPPORT	
		D.229	blanco/white	100 m	0,37 €/m	-	90 mm
Armadora con bolsas Buck am with pouches / Ruban entoilage a c pouches	 Poliéster 100% 4 / 6 Bolsas (Bags)	REF	COLOR	rollo (m) roll (m)		RAPPORT	
		D.217	blanco/white	200 m	0,84 €/m	1:2	70 mm
		D.217BG	beige	200 m	0,84 €/m	1:2	70 mm
		D.218	blanco/white	200 m	0,98 €/m	1:2	90 mm
		D.218BG	beige	200 m	0,98 €/m	1:2	90 mm
D.235TR	transparente	100 m	1,24 €/m	1:2	120 mm		
Cinta Armadora transparente Transparent Buck am / Ruban entoilage transparent	 Poliéster 100%	REF	COLOR	rollo (m) roll (m)		RAPPORT	
		D.222TR	transparente	200 m	0,72 €/m	-	90 mm
		D.234TR	transparente	100 m	0,82 €/m	-	120 mm
		D.233TR	transparente	100 m	1,04 €/m	-	135 mm
100 Anillas frunce para Ollao Shirring ring for eye let / Renforcement forme pour oeillets		REF	COLOR	rollo (m) roll (m)		RAPPORT	
		H.1120	blanco/white	1	24,10 €/100 u	-	45 mm

* Se puede combinar con ollaos de latón y de policarbonato.
 Suitable for brass and plastic eye lets.
 Utilisable pour oeillets en plastic et en laiton.

Cintas fruncidoras libres/ Shirring curtain Tapes / Rubans fronceurs

Fruncidora 75 Shirring tape 75 / Ruban fronceur 75	 Poliéster 100% 2 Bolsas (bags) - 4 Cordones (Cords)	REF	COLOR	rollo (m) roll (m)		RAPPORT	
		D.206	blanco/white	150 m	0,92 €/m	-	75 mm

Cintas de Ojales / Eϕ let Tape / Rubans d'oeillets

Cinta Ojales
Eϕ let tape /
Rubans d'oeillets

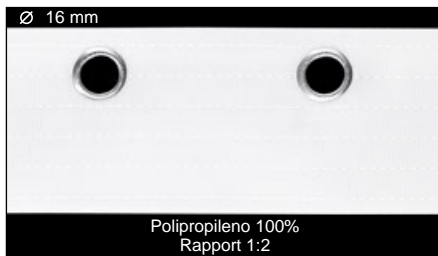

REF	COLOR	rollo (m) roll (m)	€	RAPPORT	
D.201	blanco/white	50 m	1,48 €/m	-	80 mm

Cintas de ojales con embellecedor / Eϕ let Tape with grommets / Rubans a anneux aϕ c oeillet décoratif

Cinta ollao
Eϕ let Tape with
grommets /
Ruban aϕ c oeillet
décoratif

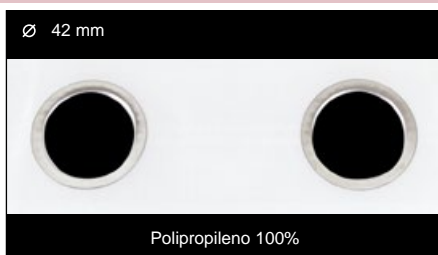

REF	COLOR	rollo (m) roll (m)	€	RAPPORT	
D.69	blanco/white	50 m	1,90 €/m	-	80 mm

Ollao embellecedor
Oro
Eϕ let Gold /
Oeillet décoratif
Or



REF	BARRA POLE TRINGLE	U	€	€	cm
H.19	30	100	0,84 €/u		

Ollao embellecedor
Negro
Eϕ let Black /
Oeillet décoratif
Noir



REF	BARRA POLE TRINGLE	U	€	€	cm
H.19N	30	100	0,84 €/u		

Ollao embellecedor
Plata Brillo
Eϕ let
Bright Nickle I /
Oeillet décoratif
Nickel Plaqué



REF	BARRA POLE TRINGLE	U	€	€	cm
H.19PL	30	100	0,84 €/u		

Ollao embellecedor
Plata Mate
Eϕ let
Matt Nickle I /
Oeillet décoratif
Nickle I Satiné



REF	BARRA POLE TRINGLE	U	€	€	cm
H.19PM	30	100	0,84 €/u		

Ollaos Policarbonato / Polycarbonate Eyelets / Oeillets Polycarbonate - 100%

OLLAOS DE POLICARBONATO PARA BARRAS DE 19 y 30 mm /
POLYCARBONATE EYELETS FOR 19 & 30 mm POLE /
OEILLETES POLYCARBONATE POUR TRINGLE 19 et 30 mm

- * Ollaos para aplicación con prensa
- * Application with eyelet press machine /
- * Application avec machine presse oeillets

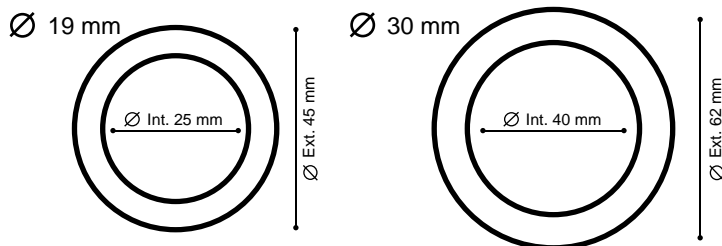

REF	Ø BARRA POLE TRINGLE	U	€	€	cm
H.1201	19	50	0,46 €/u		
H.1101	30	50	0,76 €/u		



REF	Ø BARRA POLE TRINGLE	U	€	€	cm
H.1202	19	50	0,46 €/u		
H.1102	30	50	0,76 €/u		



REF	Ø BARRA POLE TRINGLE	U	€	€	cm
H.1203	19	50	0,46 €/u		
H.1103	30	50	0,76 €/u		



REF	Ø BARRA POLE TRINGLE	U	€	€	cm
H.1204	19	50	0,46 €/u		
H.1104	30	50	0,76 €/u		

*Hasta fin de existencias / Until the end of stocks / Jusqu'à la fin de stocks



REF	Ø BARRA POLE TRINGLE	U	€	€	cm
H.1205	19	50	0,46 €/u		
H.1105	30	50	0,76 €/u		

*Hasta fin de existencias / Until the end of stocks / Jusqu'à la fin de stocks





REF	Ø BARRA POLE TRINGLE	U	€	€	cm
H.1206	19	50	0,46 €/u		
H.1106	30	50	0,76 €/u		

*Hasta fin de existencias / Until the end of stocks / Jusqu'à la fin de stocks



REF	Ø BARRA POLE TRINGLE	U	€	€	cm
H.1207	19	50	0,64 €/u		
H.1107	30	50	0,94 €/u		

Ollaos Policarbonato / Polya rbonate Eϕ lets / Oeillets Polya rbonate - 100%

<p>Ollao Latón Mate Satin brass eϕ let / Oeillet laiton satiné</p> 	<table border="1"> <thead> <tr> <th>REF</th> <th>Ø BARRA POLE TRINGLE</th> <th>U</th> <th>€</th> <th>€</th> <th>cm</th> </tr> </thead> <tbody> <tr> <td>H.1208</td> <td>19</td> <td>50</td> <td>0,64 €/u</td> <td></td> <td></td> </tr> <tr> <td>H.1108</td> <td>30</td> <td>50</td> <td>0,94 €/u</td> <td></td> <td></td> </tr> </tbody> </table>	REF	Ø BARRA POLE TRINGLE	U	€	€	cm	H.1208	19	50	0,64 €/u			H.1108	30	50	0,94 €/u		
REF	Ø BARRA POLE TRINGLE	U	€	€	cm														
H.1208	19	50	0,64 €/u																
H.1108	30	50	0,94 €/u																
<p>Ollao pino Natural eϕ let / Oeillet naturel</p> 	<table border="1"> <thead> <tr> <th>REF</th> <th>Ø BARRA POLE TRINGLE</th> <th>U</th> <th>€</th> <th>€</th> <th>cm</th> </tr> </thead> <tbody> <tr> <td>H.1209</td> <td>19</td> <td>50</td> <td>0,64 €/u</td> <td></td> <td></td> </tr> <tr> <td>H.1109</td> <td>30</td> <td>50</td> <td>0,94 €/u</td> <td></td> <td></td> </tr> </tbody> </table> <p><i>*Hasta fin de existencias / Until the end of stocks / Jusqu'a la fin de stocks</i></p>	REF	Ø BARRA POLE TRINGLE	U	€	€	cm	H.1209	19	50	0,64 €/u			H.1109	30	50	0,94 €/u		
REF	Ø BARRA POLE TRINGLE	U	€	€	cm														
H.1209	19	50	0,64 €/u																
H.1109	30	50	0,94 €/u																
<p>Ollao roble Oak eϕ let / Oeillet Chêne</p> 	<table border="1"> <thead> <tr> <th>REF</th> <th>Ø BARRA POLE TRINGLE</th> <th>U</th> <th>€</th> <th>€</th> <th>cm</th> </tr> </thead> <tbody> <tr> <td>H.1210</td> <td>19</td> <td>50</td> <td>0,64 €/u</td> <td></td> <td></td> </tr> <tr> <td>H.1110</td> <td>30</td> <td>50</td> <td>0,94 €/u</td> <td></td> <td></td> </tr> </tbody> </table> <p><i>*Hasta fin de existencias / Until the end of stocks / Jusqu'a la fin de stocks</i></p>	REF	Ø BARRA POLE TRINGLE	U	€	€	cm	H.1210	19	50	0,64 €/u			H.1110	30	50	0,94 €/u		
REF	Ø BARRA POLE TRINGLE	U	€	€	cm														
H.1210	19	50	0,64 €/u																
H.1110	30	50	0,94 €/u																
<p>Ollao óxido Black rust eϕ let / Deillet noir-rouille</p> 	<table border="1"> <thead> <tr> <th>REF</th> <th>Ø BARRA POLE TRINGLE</th> <th>U</th> <th>€</th> <th>€</th> <th>cm</th> </tr> </thead> <tbody> <tr> <td>H.1211</td> <td>19</td> <td>50</td> <td>0,64 €/u</td> <td></td> <td></td> </tr> <tr> <td>H.1111</td> <td>30</td> <td>50</td> <td>0,94 €/u</td> <td></td> <td></td> </tr> </tbody> </table> <p><i>*Hasta fin de existencias / Until the end of stocks / Jusqu'a la fin de stocks</i></p>	REF	Ø BARRA POLE TRINGLE	U	€	€	cm	H.1211	19	50	0,64 €/u			H.1111	30	50	0,94 €/u		
REF	Ø BARRA POLE TRINGLE	U	€	€	cm														
H.1211	19	50	0,64 €/u																
H.1111	30	50	0,94 €/u																
<p>Ollao negro-oro Black gold eϕ let / Oeillet noir-or</p> 	<table border="1"> <thead> <tr> <th>REF</th> <th>Ø BARRA POLE TRINGLE</th> <th>U</th> <th>€</th> <th>€</th> <th>cm</th> </tr> </thead> <tbody> <tr> <td>H.1212</td> <td>19</td> <td>50</td> <td>0,64 €/u</td> <td></td> <td></td> </tr> <tr> <td>H.1112</td> <td>30</td> <td>50</td> <td>0,94 €/u</td> <td></td> <td></td> </tr> </tbody> </table>	REF	Ø BARRA POLE TRINGLE	U	€	€	cm	H.1212	19	50	0,64 €/u			H.1112	30	50	0,94 €/u		
REF	Ø BARRA POLE TRINGLE	U	€	€	cm														
H.1212	19	50	0,64 €/u																
H.1112	30	50	0,94 €/u																

Ollaos Latón / Brass Eϕ lets / Oeillets Laiton - 100%

OLLAOS DE LATÓN PARA BARRAS DE 19 y 30 mm / BRASS EYELETS FOR 19 & 30 mm POLE / OEILLETS LAITON POUR TRINGLE 19 et 30 mm



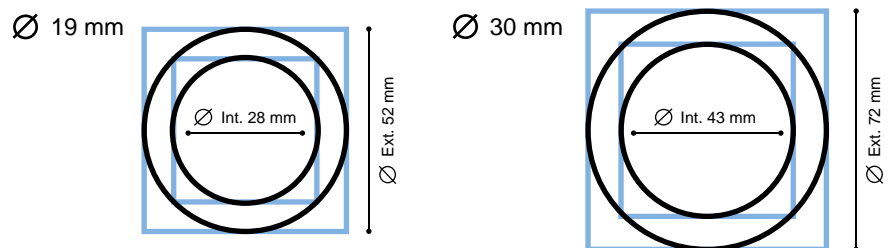





- * Ollao para aplicación con prensa H.104
- * Application with eyelet press machine H.104 /
- * Application avec machine presse oeillets H.104



<p>Ollao Latón Color Blanco Brass eϕ let White Color / Oeillet Laiton Color Blanc</p> 	<table border="1"> <thead> <tr> <th>REF</th> <th>Ø BARRA POLE TRINGLE</th> <th>U</th> <th>€</th> <th>€</th> <th>cm</th> </tr> </thead> <tbody> <tr> <td>H.100BL</td> <td>30</td> <td>50</td> <td>1,98 €/u</td> <td></td> <td></td> </tr> </tbody> </table>	REF	Ø BARRA POLE TRINGLE	U	€	€	cm	H.100BL	30	50	1,98 €/u		
REF	Ø BARRA POLE TRINGLE	U	€	€	cm								
H.100BL	30	50	1,98 €/u										

NEW

Ollaos Latón / Brass Eyelets / Oeillets Laiton - 100%

<p>Ollaos Latón Color Negro</p> <p>Brass eyelet Black Color / Oeillet Laiton Couleur Noir</p>		<table border="1"> <thead> <tr> <th>REF</th> <th>Ø BARRA POLE TRINGLE</th> <th></th> <th></th> <th></th> <th></th> </tr> </thead> <tbody> <tr> <td>H.101N</td> <td>19</td> <td>50</td> <td>1,86 €/u</td> <td></td> <td></td> </tr> <tr> <td>H.100N</td> <td>30</td> <td>50</td> <td>1,98 €/u</td> <td></td> <td></td> </tr> </tbody> </table>	REF	Ø BARRA POLE TRINGLE					H.101N	19	50	1,86 €/u			H.100N	30	50	1,98 €/u		
REF	Ø BARRA POLE TRINGLE																			
H.101N	19	50	1,86 €/u																	
H.100N	30	50	1,98 €/u																	
<p>Ollaos Latón Color Negro</p> <p>Brass eyelet Black Color / Oeillet Laiton Couleur Noir</p>		<table border="1"> <thead> <tr> <th>REF</th> <th>Ø BARRA POLE TRINGLE</th> <th></th> <th></th> <th></th> <th></th> </tr> </thead> <tbody> <tr> <td>H.103N</td> <td>19</td> <td>50</td> <td>1,90 €/u</td> <td></td> <td></td> </tr> <tr> <td>H.102N</td> <td>30</td> <td>50</td> <td>2,44 €/u</td> <td></td> <td></td> </tr> </tbody> </table>	REF	Ø BARRA POLE TRINGLE					H.103N	19	50	1,90 €/u			H.102N	30	50	2,44 €/u		
REF	Ø BARRA POLE TRINGLE																			
H.103N	19	50	1,90 €/u																	
H.102N	30	50	2,44 €/u																	
<p>Ollaos Latón Color Acero</p> <p>Brass eyelet Steel Color / Oeillet Laiton Couleur Acier</p>		<table border="1"> <thead> <tr> <th>REF</th> <th>Ø BARRA POLE TRINGLE</th> <th></th> <th></th> <th></th> <th></th> </tr> </thead> <tbody> <tr> <td>H.101A</td> <td>19</td> <td>50</td> <td>1,60 €/u</td> <td></td> <td></td> </tr> <tr> <td>H.100A</td> <td>30</td> <td>50</td> <td>1,98 €/u</td> <td></td> <td></td> </tr> </tbody> </table>	REF	Ø BARRA POLE TRINGLE					H.101A	19	50	1,60 €/u			H.100A	30	50	1,98 €/u		
REF	Ø BARRA POLE TRINGLE																			
H.101A	19	50	1,60 €/u																	
H.100A	30	50	1,98 €/u																	
<p>Ollaos Latón Color Acero</p> <p>Brass eyelet Steel Color / Oeillet Laiton Couleur Acier</p>		<table border="1"> <thead> <tr> <th>REF</th> <th>Ø BARRA POLE TRINGLE</th> <th></th> <th></th> <th></th> <th></th> </tr> </thead> <tbody> <tr> <td>H.103A</td> <td>19</td> <td>50</td> <td>1,90 €/u</td> <td></td> <td></td> </tr> <tr> <td>H.102A</td> <td>30</td> <td>50</td> <td>2,34 €/u</td> <td></td> <td></td> </tr> </tbody> </table>	REF	Ø BARRA POLE TRINGLE					H.103A	19	50	1,90 €/u			H.102A	30	50	2,34 €/u		
REF	Ø BARRA POLE TRINGLE																			
H.103A	19	50	1,90 €/u																	
H.102A	30	50	2,34 €/u																	
<p>Ollaos Latón Color Dorado</p> <p>Brass eyelet Gold Color / Oeillet Laiton Couleur Or</p>		<table border="1"> <thead> <tr> <th>REF</th> <th>Ø BARRA POLE TRINGLE</th> <th></th> <th></th> <th></th> <th></th> </tr> </thead> <tbody> <tr> <td>H.101BR</td> <td>19</td> <td>50</td> <td>1,86 €/u</td> <td></td> <td></td> </tr> <tr> <td>H.100BR</td> <td>30</td> <td>50</td> <td>2,22 €/u</td> <td></td> <td></td> </tr> </tbody> </table>	REF	Ø BARRA POLE TRINGLE					H.101BR	19	50	1,86 €/u			H.100BR	30	50	2,22 €/u		
REF	Ø BARRA POLE TRINGLE																			
H.101BR	19	50	1,86 €/u																	
H.100BR	30	50	2,22 €/u																	
<p>Ollaos Latón Color Dorado</p> <p>Brass eyelet Gold Color / Oeillet Laiton Couleur Or</p>		<table border="1"> <thead> <tr> <th>REF</th> <th>Ø BARRA POLE TRINGLE</th> <th></th> <th></th> <th></th> <th></th> </tr> </thead> <tbody> <tr> <td>H.103BR</td> <td>19</td> <td>50</td> <td>1,90 €/u</td> <td></td> <td></td> </tr> <tr> <td>H.102BR</td> <td>30</td> <td>50</td> <td>2,44 €/u</td> <td></td> <td></td> </tr> </tbody> </table>	REF	Ø BARRA POLE TRINGLE					H.103BR	19	50	1,90 €/u			H.102BR	30	50	2,44 €/u		
REF	Ø BARRA POLE TRINGLE																			
H.103BR	19	50	1,90 €/u																	
H.102BR	30	50	2,44 €/u																	
<p>Ollaos Latón Color Cuero</p> <p>Brass eyelet Antique Color / Oeillet Laiton Couleur Cuir</p>		<table border="1"> <thead> <tr> <th>REF</th> <th>Ø BARRA POLE TRINGLE</th> <th></th> <th></th> <th></th> <th></th> </tr> </thead> <tbody> <tr> <td>H.101C</td> <td>19</td> <td>50</td> <td>1,86 €/u</td> <td></td> <td></td> </tr> <tr> <td>H.100C</td> <td>30</td> <td>50</td> <td>2,22 €/u</td> <td></td> <td></td> </tr> </tbody> </table>	REF	Ø BARRA POLE TRINGLE					H.101C	19	50	1,86 €/u			H.100C	30	50	2,22 €/u		
REF	Ø BARRA POLE TRINGLE																			
H.101C	19	50	1,86 €/u																	
H.100C	30	50	2,22 €/u																	
<p>Ollaos Latón Color Cuero</p> <p>Brass eyelet Antique Color / Oeillet Laiton Couleur Cuir</p>		<table border="1"> <thead> <tr> <th>REF</th> <th>Ø BARRA POLE TRINGLE</th> <th></th> <th></th> <th></th> <th></th> </tr> </thead> <tbody> <tr> <td>H.103C</td> <td>19</td> <td>50</td> <td>2,16 €/u</td> <td></td> <td></td> </tr> <tr> <td>H.102C</td> <td>30</td> <td>50</td> <td>2,44 €/u</td> <td></td> <td></td> </tr> </tbody> </table>	REF	Ø BARRA POLE TRINGLE					H.103C	19	50	2,16 €/u			H.102C	30	50	2,44 €/u		
REF	Ø BARRA POLE TRINGLE																			
H.103C	19	50	2,16 €/u																	
H.102C	30	50	2,44 €/u																	

Ollaos Latón / Brass Eyelets / Oeillets Laiton - 100%

Ollaos Latón
Color Cuero Claro

Brass eyelet
Light Antique Color /
Oeillet Laiton
Couleur Cuir Clair



REF	Ø BARRA POLE TRINGLE	U	€	€	cm
H.101CC	19	50	1,86 €/u		
H.100CC	30	50	2,22 €/u		

Ollaos Latón
Color Cuero Claro

Brass eyelet
Light Antique Color /
Oeillet Laiton
Couleur Cuir Clair



REF	Ø BARRA POLE TRINGLE	U	€	€	cm
H.103CC	19	50	2,16 €/u		
H.102CC	30	50	2,44 €/u		

Ollaos de Plástico MANUALES / Plastic SELF-LOCK Manual Eyelets / Oeillet MANUEL Plastique - 100%

OLLAOS DE PLÁSTICO MANUAL (Sin prensa) /
MANUAL PLASTIC EYELET (without press machine) /
OEILLET MANUEL PLASTIQUE (sans machine presse)

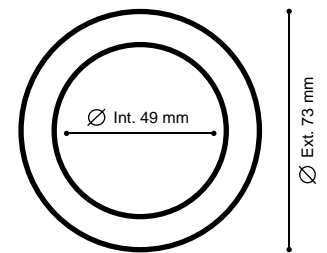

Cinta perforada para
Ollaos Plástico Manual.
Diámetro 60mm
Punch tape for plastic
manual eyelets,
60mm diameter /
Ruban perforé pour
oeillets à main en
plastic, 60mm diameter

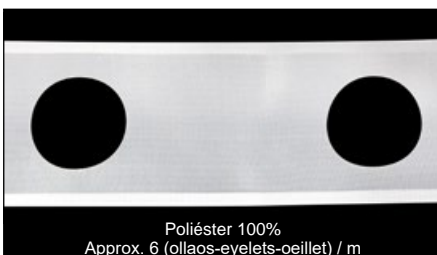

Poliéster 100%
Approx. 6 (ollaos-eyelets-oeillet) / m

REF	COLOR	rollo (m) roll (m)	€	RAPPORT	cm
D.293TR	transparente	100 m	1,42 €/m	-	100 mm

NEW

Ollaos Plástico Manual
Color Transparente

Manual Plastic eyelet
Transparent Color /
Oeillet Manuel Plastic
Color Transparent



REF	Ø BARRA POLE TRINGLE	U	€	€	cm
H.1301	30	100	0,50 €/u		

Ollaos Plástico Manual
Color Blanco

Manual Plastic eyelet
White Color /
Oeillet Manuel Plastic
Color Blanc



REF	Ø BARRA POLE TRINGLE	U	€	€	cm
H.1302	30	100	0,50 €/u		

Ollaos Plástico Manual
Color Negro

Manual Plastic eyelet
Matt Black Color /
Oeillet Manuel Plastic
Color Noir Mat



REF	Ø BARRA POLE TRINGLE	U	€	€	cm
H.1303N	30	100	0,50 €/u		

Ollaos de Plástico MANUALES / Plastic SELF-LOCK Manual Eyelets / Oeillet MANUEL en Plastic - 100%

Ollaos de Plástico Manual
Color Plata Mate

Manual Plastic eyelet
Pewter Color /
Oeillet Manuel Plastic
Pewter Mat



REF	Ø BARRA POLE TRINGLE	U	€	€	cm
H.1307	30	100	0,50 €/u		

Ollaos de Plástico Manual
Color Oro Mate

Manual Plastic eyelet
Matt Gold Color /
Oeillet Manuel Plastic
Color Or Mat



REF	Ø BARRA POLE TRINGLE	U	€	€	cm
H.1308	30	100	0,50 €/u		

Ollaos de Plástico Manual
Color Beige

Manual Plastic eyelet
Beige Color /
Oeillet Manuel Plastic
Color beige

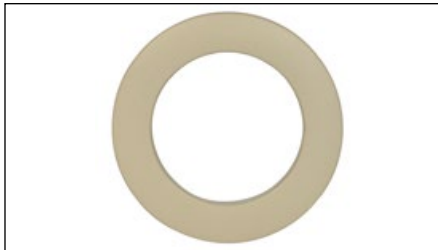

REF	Ø BARRA POLE TRINGLE	U	€	€	cm
H.1313	30	100	0,50 €/u		

Ollaos de Plástico Manual
Color Marrón

Manual Plastic eyelet
Brown Color /
Oeillet Manuel Plastic
Color Marron



REF	Ø BARRA POLE TRINGLE	U	€	€	cm
H.1314	30	100	0,50 €/u		

Ollaos de Plástico Manual
Color Gris Metálico

Manual Plastic eyelet
Metallic Grey Color /
Oeillet Manuel Plastic
Color Gris Métallique



REF	Ø BARRA POLE TRINGLE	U	€	€	cm
H.1315	30	100	0,50 €/u		

Ollaos de Plástico Manual
Color Cuero Mate

Manual Plastic eyelet
Matt Leather Color /
Oeillet Manuel Plastic
Color Cuir Mat



REF	Ø BARRA POLE TRINGLE	U	€	€	cm
H.1316	30	100	0,50 €/u		

Ollaos de Plástico Manual
Color Níquel

Manual Plastic eyelet
Nickel Color /
Oeillet Manuel Plastic
Color Nickel



REF	Ø BARRA POLE TRINGLE	U	€	€	cm
H.1317	30	100	0,50 €/u		

Ollaos de Plástico Manual
Color Latón Brillo

Manual Plastic eyelet
Bright Brass Color /
Oeillet Manuel Plastic
Color Laiton Brillant



REF	Ø BARRA POLE TRINGLE	U	€	€	cm
H.1318	30	100	0,50 €/u		

Accesorios para Ollaos / Eyelets Accessories / Accessoires pour Oeillets

Prensa para ollaos

Eyelet press /
Presse à oeillets

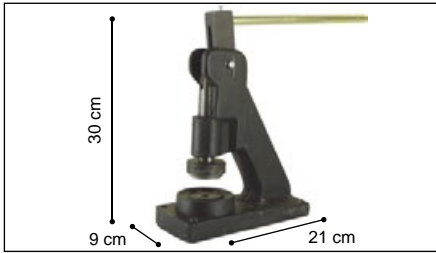

REF	Ø	U	€	1	cm
H.104		1	644,00 €		

Juego matricería completo para Ollaos de Latón (43/28 mm)
Complete tooling set for Brass Eyelets (43/28 mm) / Jeux de matrices complet pour Laiton Oeillets (43/28 mm)



REF	Ø	U	€	1	cm
H.105		1	300,52 €		

Juego remachador para Ollaos de Latón (43/28 mm)

Pressing tooling kit for Brass Eyelet (43/28mm) / Jeux sertissage pour Laiton Oeillets (43/28 mm)



REF	Ø	BARRA POLE TRINGLE	U	€	1	cm
H.107		19	1	50,46 €		
H.106		30	1	50,46 €		

Juego cortador para Ollaos de Latón

Hole punch tooling kit for Brass Eyelets (43/28mm) / Jeux de coupage pour Laiton Oeillets (43/28 mm)



REF	Ø	BARRA POLE TRINGLE	U	€	1	cm
H.109		19	1	92,44 €		
H.108		30	1	107,16 €		

Juego matricería completo para Policarbonato (40/25 mm)
Complete tooling set for Polycarbonate Eyelets (40/25 mm) / Jeux de matrices complet pour Polycarbonate Oeillets (40/25 mm)



REF	Ø	U	€	1	cm
H.111		1	407,22 €		

Juego matricería para Ollaos de Policarbonato (40/25 mm)
Punch&Press tooling set for Polycarbonate Eyelets (40/25 mm) / Jeux de sertissage et coupage pour Polycarbonate Oeillets (40/25mm)



REF	Ø	BARRA POLE TRINGLE	U	€	1	cm
H.113		19	1	176,50 €		
H.112		30	1	230,72€		

Muestra de Ollaos

Demo sample of Eyelets / Bande d'échantillon d'Oeillets

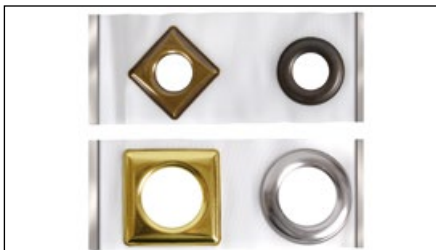

REF	Ø	U	€	1	cm
M.106		1	14,10 €		

Muestra de Ollaos Plásticos Manuales

Sample Plastic Self-lock Manual Eyelets / Echantillon oeillets plastic auto-agrippants



REF	Ø	U	€	1	cm
M.107		1	5,14 €		



 Soportes Rápidos de “quita y pon”, para ventanas y/o puertas de aluminio que no requieren taladrar ni el uso de tornillos de fijación.

Hay dos modelos para sujeción por su parte Superior o Frontal.

Además se ofrece en dos acabados: blanco y gris.

 “Quick brackets for instant installation on perforated aluminium windows or doors. No drilling nor fixing screws.

Two models available either for ceiling or face fixing.

Also two colours are offered: white and grey.

 Supports express “pose et quitte” pour fenêtres ou portes en aluminium qui ne peuvent pas être perforées.

2 modèles différents sont proposés: fixation sur la partie supérieure ou de face.

De plus, ils sont disponibles en blanc et gris.

SopORTE
parte Frontal
Blanco

Face Brack t
White /
Support de Face
Blanc



REF	∅	U	€	€ ¹	cm
F.8BL		100	5,76 €	6,62 €	

SopORTE
parte Frontal
Gris

Face Brack t
Grey /
Support de Face
Grey



REF	∅	U	€	€ ¹	cm
F.8GR		100	5,76 €	6,62 €	

SopORTE parte
Superior Blanco

Ceiling Brack t
White /
Support supérieur
Blanc



REF	∅	U	€	€ ¹	cm
F.7BL		100	6,80 €	7,82 €	

SopORTE parte
Superior Gris

Ceiling Brack t
Grey /
Support supérieur
Grey



REF	∅	U	€	€ ¹	cm
F.7GR		100	6,80 €	7,82 €	

Accesorios / Accessories / Accessoires

Deslizadores

Gliders /
Glisseurs



REF	∅	U	€	€ ¹	cm
H.919		100	0,36 €	0,43 €	
H.930		100	0,36 €	0,43 €	

Contrapesos / Cordweight / Contrepoids

Contrapeso Latón con protector Pequeño Plata
Small Brass Cordweight with protector Nickel Plated / Contrepoids petit laiton avec protecteur Plaqué Argent

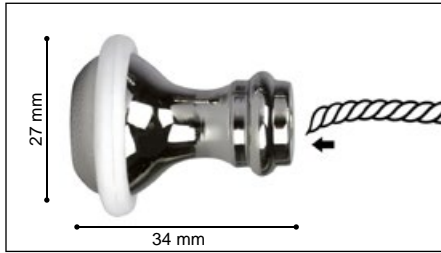

REF	∅	U	€	€	cm
R.1187PL		25	4,68 €	5,38 €	

Contrapeso Latón con protector Pequeño Pulido
Small Brass Cordweight with protector Gold Plated / Contrepoids petit laiton avec protecteur Plaqué Or

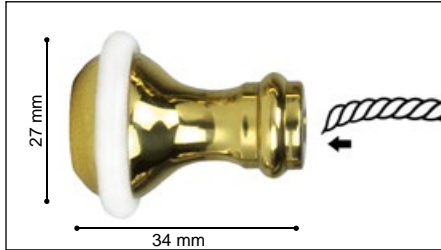

REF	∅	U	€	€	cm
R.1187PU		25	3,92 €	4,51 €	

Contrapeso Latón con protector Grande Plata
Large Brass Cordweight with protector Nickel Plated / Contrepoids grand laiton avec protecteur Plaqué Argent



REF	∅	U	€	€	cm
R.1189PL		25	5,96 €	6,85 €	

Contrapeso Latón con protector Grande Pulido
Large Brass Cordweight with protector Gold Plated / Contrepoids grand laiton avec protecteur Plaqué Or

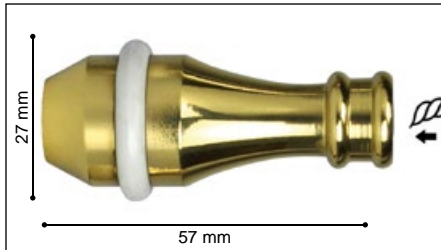

REF	∅	U	€	€	cm
R.1189PU		25	4,98 €	5,73 €	

Contrapeso Mini (43 g aprox.)
Mini-cordweight / Mini-contrepoids

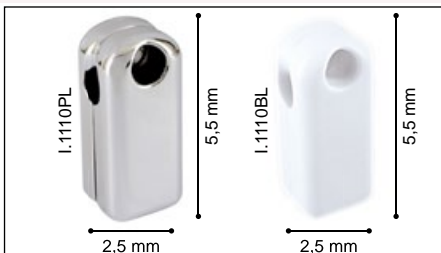

REF	∅	U	€	€	cm
I.1110BL		25	1,40 €	1,61 €	
I.1110PL		25	2,12 €	2,44 €	

NEW

Contrapeso (23 g aprox.)
Mini-cordweight / Mini-contrepoids

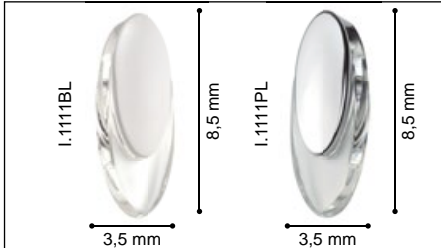

REF	∅	U	€	€	cm
I.1111BL		25	1,18 €	1,36 €	
I.1111PL		25	2,46 €	2,83 €	

NEW

Contrapeso petaca
Cordweight / contrepoids



REF	∅	U	€	€	cm
I.1700		25	2,08 €	2,39 €	

Contrapeso
Cordweight / Contrepoids



REF	∅	U	€	€	cm
I.1150		25	1,52 €	1,82 €	
I.1150BC		25	1,70 €	2,04 €	
I.1150GR		25	1,70 €	2,04 €	
I.1150N		25	1,70 €	2,04 €	

Una ventana está terminada cuando está decorada.



ALTRAN SOLUTIONS S.L.

Ctra Valencia-Ademuz Km 21,9
46181 Benisanó (Valencia) Spain
Telf.: 0034 96 113 61 53
Fax: 0034 96 113 61 27

VENTAS NACIONAL

administracion@altransolutions.es

INTERNATIONAL SALES

exportadm@altransolutions.es

export@altransolutions.es